

8MLHT 1995 / CYLINDER CRANKCASE

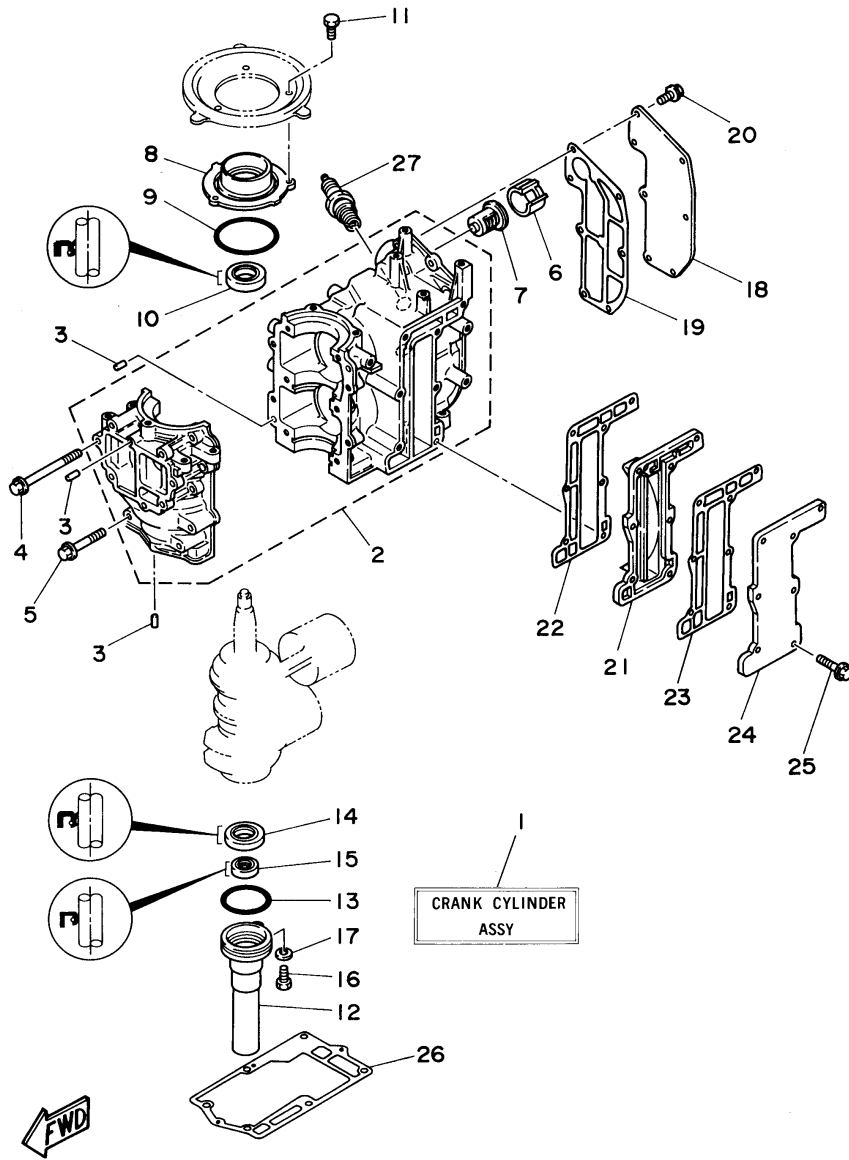

©2014 Yamaha Motor Corporation, U.S.A. All rights reserved.

## Part List

8MLHT 1995 / CYLINDER CRANKCASE

REF - NO	PART NUMBER	PART NAME	QUANTITY	REMARKS
1	6G1-W0090-04-4D	CRANK CYLINDER ASSEMBLY (REF. # 2~25 & CRANKSHAFT - PI)	1	
2	6G1-15100-00-94	CRANKCASE ASSEMBLY	1	
3	93604-08062-00	PIN, DOWEL	4	
4	90105-06M26-00	BOLT, FLANGE	6	
5	90105-06M25-00	BOLT, FLANGE	4	
6	90387-22M50-00	COLLAR	1	
7	6E5-12411-01-00	THERMOSTAT	1	
8	6G1-15359-01-94	HOUSING, OIL SEAL	1	
9	93210-54M54-00	O-RING	1	
10	93102-20M25-00	OIL SEAL	1	
11	97095-06016-00	BOLT	3	
12	6G1-15396-01-5B	HOUSING, OIL SEAL	1	
13	93210-42159-00	.O-RING	1	
14	93101-20M29-00	OIL SEAL	1	
15	93101-12M26-00	.OIL SEAL	1	
16	97095-06016-00	BOLT	1	
17	92990-06600-00	WASHER, PLATE	1	
18	6G1-11191-01-9M	COVER, CYLINDER HEAD 1	1	
19	6G1-11193-A1-00	.GASKET, HEAD COVER 1	1	
20	90105-06M14-00	BOLT FLANGE	7	
21	6G1-41111-01-9M	INNER COVER, EXHAUST	1	
22	6G1-41112-A1-00	.GASKET, EXHAUST INNER COVER	1	
23	6G1-41114-A0-00	GASKET, EXHAUST OUTER COVER	1	
24	6G1-41113-01-9M	OUTER COVER, EXHAUST	1	
25	90105-06M24-00	BOLT, FLANGE	7	
26	6G1-45113-A1-00	GASKET, UPPER CASING	1	
27	NGK-B7HS1-00-00	PLUG, SPARK (NGK B7HS- 10)	2	UR
27	NGK-BR7HS-00-00	PLUG, SPARK	2	UR

## Part Notes

8MLHT 1995 / CYLINDER CRANKCASE

PART NUMBER	NOTE TEXT
92990-06600-00 	OEM: This part number is among the Top 100 Most Popular Marine Maintenance Parts as of March 2014.

©2014 Yamaha Motor Corporation, U.S.A. All rights reserved.

8MLHT 1995 / CRANKSHAFT PISTON

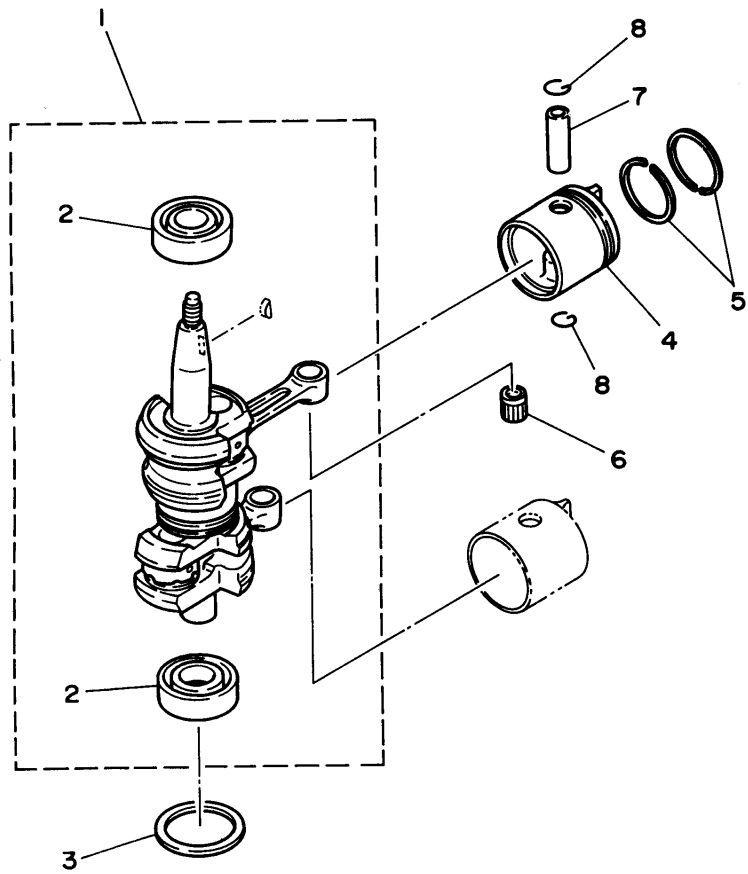

©2014 Yamaha Motor Corporation, U.S.A. All rights reserved.

## Part List

8MLHT 1995 / CRANKSHAFT PISTON

REF - NO	PART NUMBER	PART NAME	QUANTITY	REMARKS
1	6G1-11400-01-00	CRANKSHAFT ASSEMBLY	1	
2	93306-204U0-00	.BEARING	2	
3	90201-41528-00	WASHER, PLATE (90201-41303-00)	1	
4	6G1-11631-00-98	PISTON (STD)	2	
5	6G1-11610-00-00	PISTON RINGSET (STD)	2	
6	93310-112V0-00	BEARING	2	
7	6G1-11633-00-00	PIN, PISTON	2	
8	93450-13022-00	CIRCLIP	4	

8MLHT 1995 / INTAKE

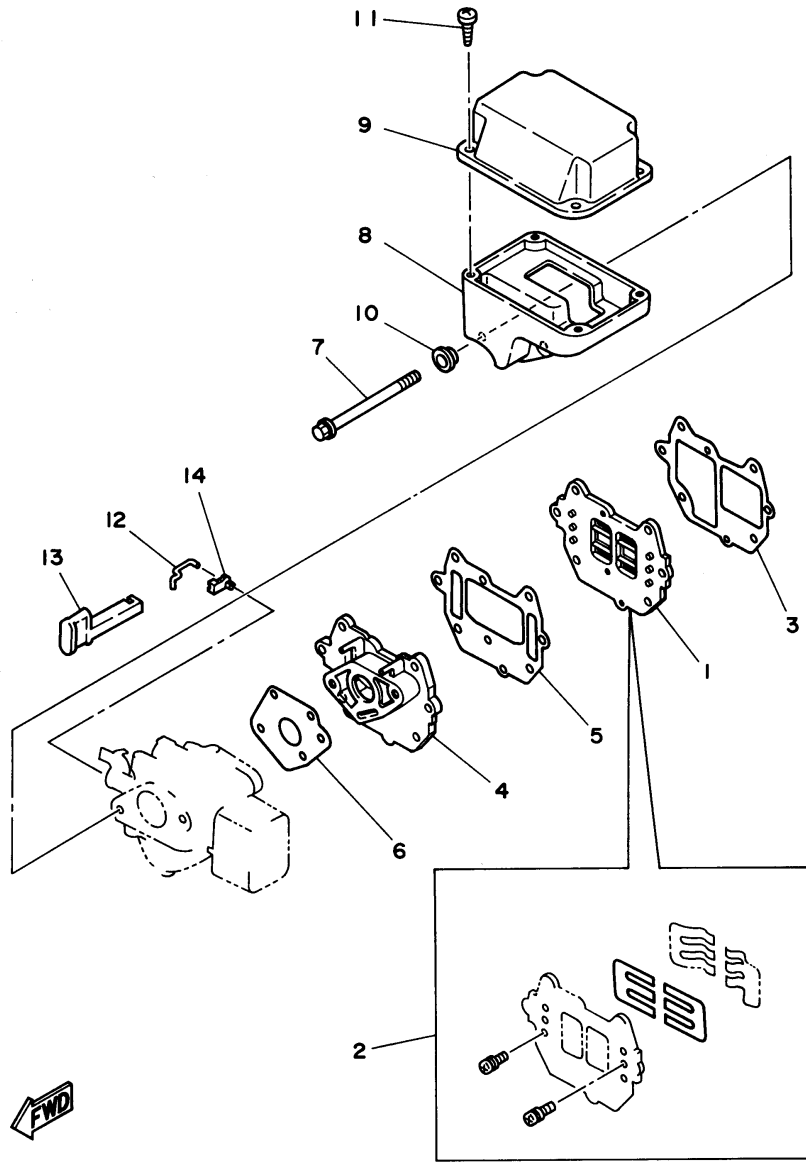

©2014 Yamaha Motor Corporation, U.S.A. All rights reserved.

## Part List

8MLHT 1995 / INTAKE

REF - NO	PART NUMBER	PART NAME	QUANTITY	REMARKS
1	6G1-13610-01-00	REED VALVE ASSY	1	
2	6G1-W0004-00-00	.REED SET	1	
3	6G1-13621-A1-00	.GASKET, VALVE SEAT	1	
4	6G1-13641-00-94	MANIFOLD 1	1	
5	6G1-13645-A1-00	.GASKET, MANIFOLD 1	1	
6	6G1-14198-A1-00	GASKET	1	
7	95895-06085-00	BOLT, FLANGE	2	
8	6G1-14417-00-00	COVER 1	1	
9	6G1-14418-00-00	COVER 2	1	
10	90387-06M70-00	COLLAR	2	
11	97780-50514-00	SCREW, TAPPING	4	
12	6G1-41256-00-00	ROD, CHOKE 1	1	
13	6G1-41271-00-00	KNOB, CHOKE	1	
14	661-41262-02-00	JOINT, CHOKE LEVER	1	

8MLHT 1995 / CARBURETOR

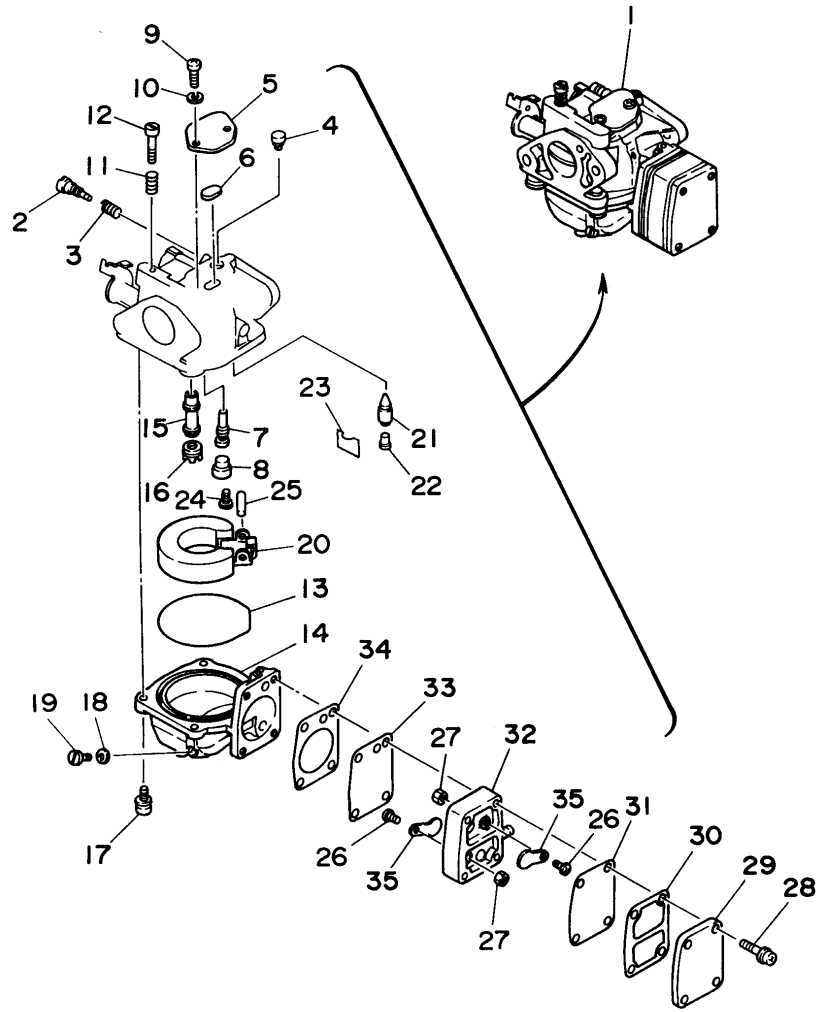

©2014 Yamaha Motor Corporation, U.S.A. All rights reserved.

## Part List

8MLHT 1995 / CARBURETOR

REF - NO	PART NUMBER	PART NAME	QUANTITY	REMARKS
1	6H6-14301-01-00	CARBURETOR ASSY 1	1	UR 6MH
1	6G1-14301-01-00	CARBURETOR ASSY 1	1	UR 8MH
2	679-14923-00-00	.SCREW, PILOT	1	
3	679-14555-00-00	.SPRING	1	
4	6G1-14966-00-00	.CAP	1	
5	6G1-14527-00-00	.PLATE	1	
6	6G1-14126-00-00	.GASKET	1	
7	6G1-14948-05-00	.JET (#45)	1	
8	676-14966-00-00	.CAP	1	
9	98580-04010-00	.SCREW, PAN HEAD	2	
10	92990-04100-00	.WASHER, SPRING	2	
11	90501-10326-00	.SPRING, COMPRESSION	1	
12	6H1-14523-00-00	.SCREW, STOP	1	
13	6G1-14984-00-00	.O-RING	1	
14	6G1-14980-01-00	.BODY, FLOAT CHAMBER	1	
15	6G1-14947-00-00	.JET, NEEDLE	1	UR 8MH
15	6H6-14947-00-00	.JET, NEEDLE	1	UR 6MH
16	676-14943-26-00	.JET, MAIN (#98)	1	
17	97980-04114-00	.SCREW, WITH WASHER	4	
18	6G1-14398-00-00	.WASHER	1	
19	6G1-14992-00-00	.SCREW, DRAIN	1	
20	6G1-14985-00-00	.FLOAT	1	
21	6G1-14546-00-00	.VALVE, NEEDLE	1	
22	676-14186-00-00	.PIN, FLOAT	1	
23	663-14159-00-00	.CLIP	1	
24	98580-04008-00	.SCREW, PAN HEAD	1	
25	688-14548-00-00	.PIN, FLOAT ARM	1	
26	98580-03006-00	.SCREW, PAN HEAD	2	
27	95380-03600-00	.NUT	2	
28	97980-04125-00	.SCREW, WITH WASHER	4	
29	6G1-24452-00-00	.COVER	1	
30	6G1-24432-00-00	.GASKET, FUEL PUMP 2	1	
31	6G1-24471-00-00	.DIAPHRAGM	1	
32	6G1-24412-01-00	.BODY 1	1	
33	6G1-24411-00-00	.DIAPHRAGM	1	
34	6G1-24431-01-00	.GASKET, FUEL PUMP 1	1	
35	6G1-24421-00-00	.VALVE, CHECK	2	



8MLHT 1995 / STARTER

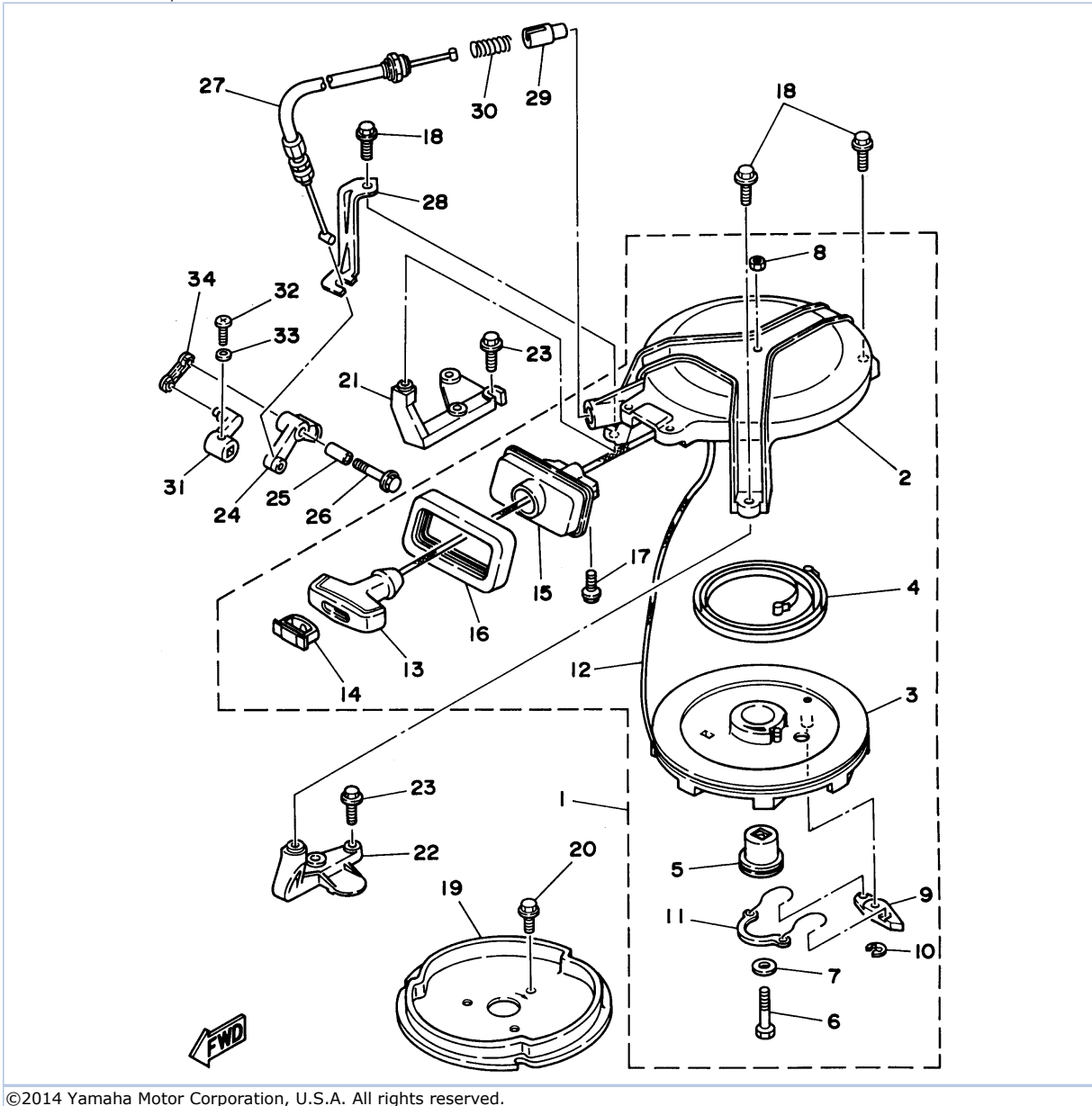

©2014 Yamaha Motor Corporation, U.S.A. All rights reserved.

## Part List

8MLHT 1995 / STARTER

REF - NO	PART NUMBER	PART NAME	QUANTITY	REMARKS
1	6G1-15710-81-00	STARTER ASSEMBLY	1	
2	6G1-15711-80-94	.CASE, STARTER	1	
3	6G1-15714-00-00	.DRUM, SHEAVE	1	
4	90510-08M03-00	.SPRING, SPIRAL	1	
5	6G1-15717-00-00	.SHAFT, STARTER	1	
6	97013-06035-00	.BOLT	1	
7	90201-06M30-00	.WASHER, PLATE	1	
8	95601-06200-00	.NUT, U-FLANGE	1	
9	677-15741-01-00	.PAWL, DRIVE	1	
10	93430-06M02-00	.CIRCLIP	1	
11	6G1-15705-00-00	.SPRING, DRIVE PAWL	1	
12	90580-40M02-00	.ROPE, STARTER	1	
13	6G1-15755-00-00	.HANDLE, STARTER	1	
14	6G1-15779-00-00	.COVER	1	
15	6G1-15758-00-00	.GUIDE, ROPE	1	
16	6G1-15762-00-00	.SEAL, RUBBER 2	1	
17	95895-06016-00	.BOLT, FLANGE	2	
18	95895-06020-00	BOLT, FLANGE	3	
19	6G1-15723-00-94	PULLEY, STARTER	1	
20	90105-06M29-00	BOLT, FLANGE	3	
21	6G1-15771-00-94	STAY 1	1	
22	6G1-15772-00-94	STAY 2	1	
23	97595-06520-00	BOLT, WITH WASHER	4	
24	6G1-15746-10-00	ARM	1	
25	6G1-15764-00-00	COLLAR 1	1	
26	95895-06025-00	BOLT, FLANGE	1	
27	6G1-15770-81-00	CABLE COMP., STARTER STOP	1	
28	6G1-15774-81-00	STAY 4	1	
29	656-15748-00-00	PLUNGER, STARTER STOP	1	
30	90501-10227-00	SPRING, COMPRESSION	1	
31	6G1-44125-80-00	LEVER, SHIFT ROD	1	
32	98580-05016-00	SCREW, PAN HEAD	1	
33	92990-05600-00	WASHER, PLATE	1	
34	6G1-15747-80-00	LINK	1	

8MLHT 1995 / FUEL

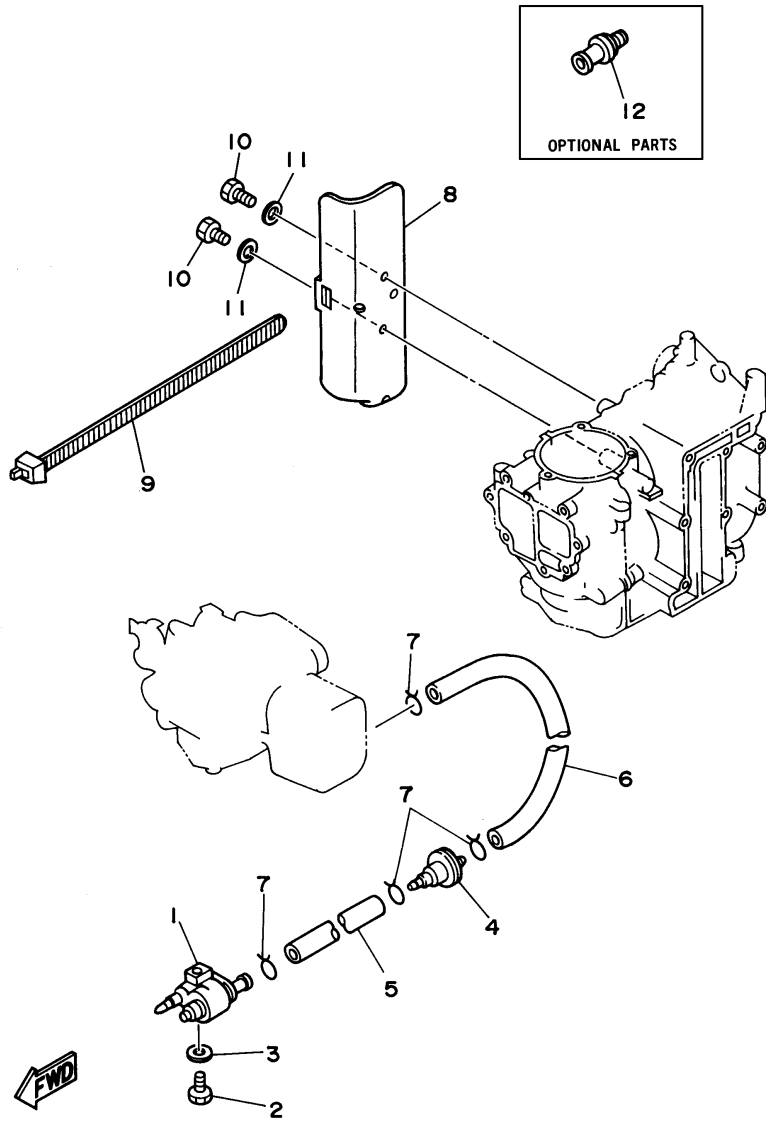

©2014 Yamaha Motor Corporation, U.S.A. All rights reserved.



## Part List

8MLHT 1995 / FUEL

REF - NO	PART NUMBER	PART NAME	QUANTITY	REMARKS
1	6G1-24304-02-00	FUEL PIPE JOINT COMP. 1	1	
2	97095-06025-00	BOLT	1	
3	92990-06600-00	WASHER, PLATE	1	
4	646-24251-02-00	.STRAINER 1	1	
5	90445-09094-00	HOSE (L210)	1	
6	90445-09220-00	HOSE (L30)	1	
7	90467-08004-00	CLIP	4	
8	6G1-28170-00-00	TOOL, HOLDER	1	
9	6E1-42694-00-00	BAND	1	
10	97095-06012-00	BOLT	2	
11	92990-06600-00	WASHER, PLATE	2	
12	ABB-FLUSH-JD-00	JET DRIVE FLUSH	1	AP

## Part Notes

8MLHT 1995 / FUEL

PART NUMBER		NOTE TEXT
92990-06600-00		OEM: This part number is among the Top 100 Most Popular Marine Maintenance Parts as of March 2014.
646-24251-02-00		OEM: This part number is among the Top 100 Most Popular Marine Maintenance Parts as of March 2014.
92990-06600-00		OEM: This part number is among the Top 100 Most Popular Marine Maintenance Parts as of March 2014.

©2014 Yamaha Motor Corporation, U.S.A. All rights reserved.

8MLHT 1995 / TOP COWLING

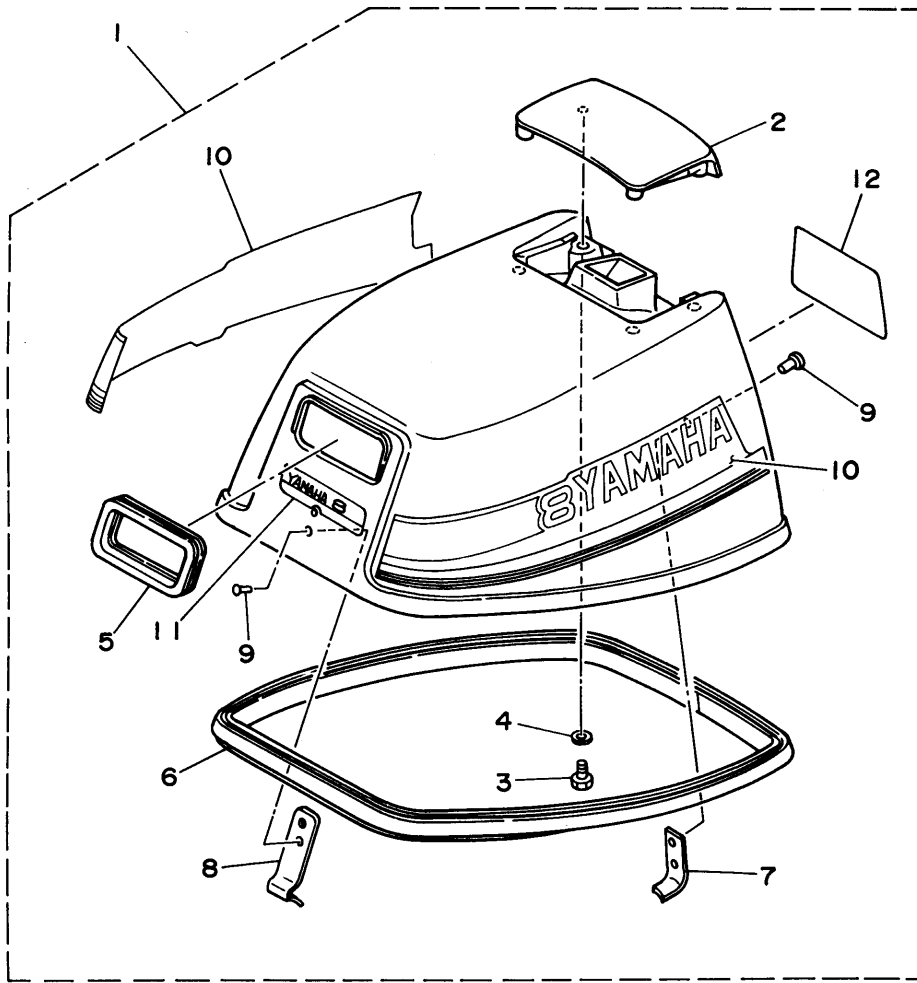

©2014 Yamaha Motor Corporation, U.S.A. All rights reserved.

## Part List

8MLHT 1995 / TOP COWLING

REF - NO	PART NUMBER	PART NAME	QUANTITY	REMARKS
1	6H6-42610-14-4D	TOP COWLING ASSEMBLY	1	UR 6MH
1	6G1-42610-14-4D	TOP COWLING ASSEMBLY	1	UR 8MH
2	6G1-42613-00-4D	.MOLDING, AIR DUCT	1	
3	97095-06016-00	.BOLT	4	
4	92990-06600-00	.WASHER, PLATE	4	
5	6G1-15761-00-00	.SEAL, RUBBER 1	1	
6	6G1-42615-00-00	.SEAL	1	
7	6G1-42647-00-00	.HOLDER, CLAMP BAND	1	
8	6G1-42651-02-00	.HOOK	1	
9	90266-04M00-00	.RIVET	4	
10	6G1-W0070-13-00	.GRAPHIC SET	1	UR 8MH
10	6H6-W0070-11-00	.GRAPHIC SET	1	UR 6MH
11	6H6-42677-10-00	.GRAPHIC, FRONT	1	UR 6MH
11	6G1-42677-10-00	.GRAPHIC, FRONT	1	UR 8MH
12	6G1-42678-11-00	.GRAPHIC, REAR	1	UR 8MH
12	6H6-42678-11-00	.GRAPHIC, REAR	1	UR 6MH

## Part Notes

8MLHT 1995 / TOP COWLING

PART NUMBER	NOTE TEXT
92990-06600-00 	OEM: This part number is among the Top 100 Most Popular Marine Maintenance Parts as of March 2014.

©2014 Yamaha Motor Corporation, U.S.A. All rights reserved.

8MLHT 1995 / BOTTOM COWLING

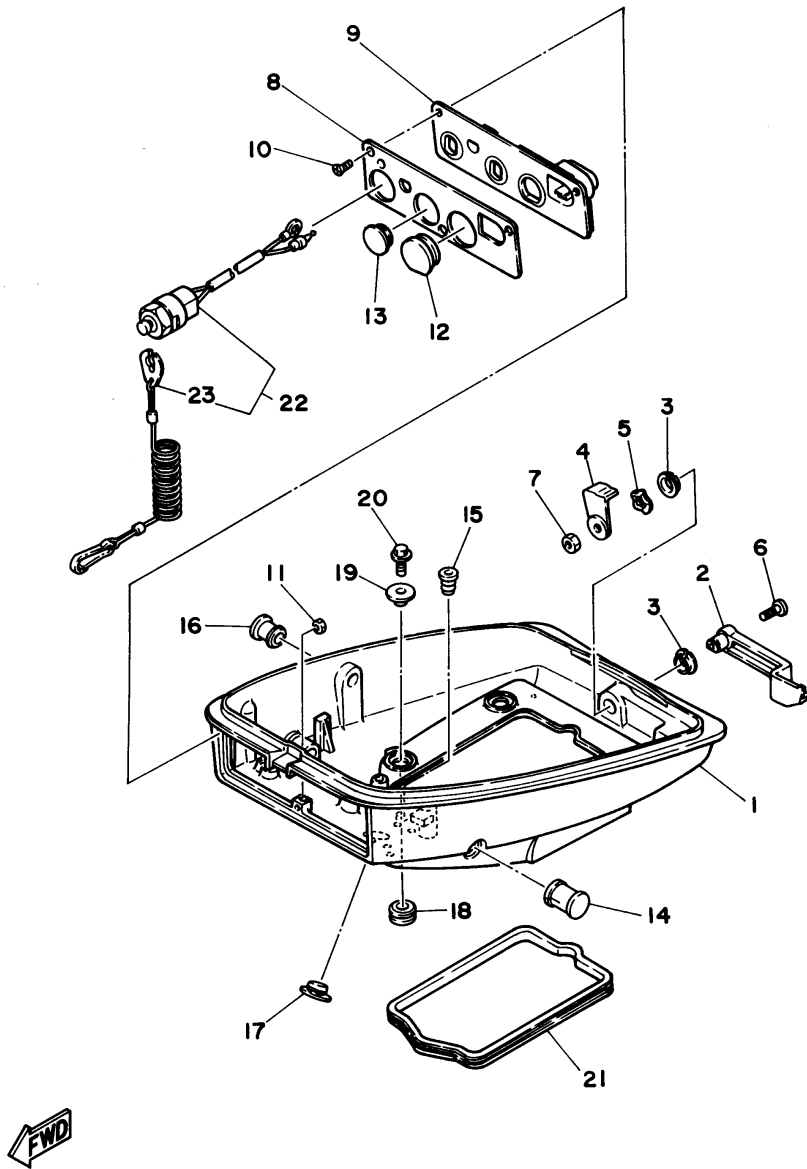

©2014 Yamaha Motor Corporation, U.S.A. All rights reserved.

## Part List

8MLHT 1995 / BOTTOM COWLING

REF - NO	PART NUMBER	PART NAME	QUANTITY	REMARKS
1	6G1-42711-01-4D	COWLING, BOTTOM	1	
2	6G1-42815-00-4D	LEVER, CLAMP	1	
3	90386-12M45-00	BUSH	2	
4	6E0-42816-00-00	LEVER, CLAMP	1	
5	90206-12052-00	WASHER, WAVE	1	
6	97895-06030-00	SCREW, PAN HEAD	1	
7	95380-06700-00	NUT	1	
8	6G1-42719-81-00	PANEL, FRONT LOWER	1	
9	6G1-42767-00-00	BRACKET	1	
10	90149-05M02-00	SCREW	3	
11	95380-05700-00	NUT	1	
12	6G1-42724-00-00	GROMMET	1	
13	6G1-42725-00-00	GROMMET	1	
14	6G1-42726-00-00	GROMMET	1	
15	6G1-42727-00-00	GROMMET	1	
16	6G1-42748-00-00	GROMMET	1	
17	6G1-26326-00-00	GROMMET	1	
18	90480-15M31-00	GROMMET	4	
19	90387-06M52-00	COLLAR	4	
20	90105-06M15-00	BOLT, FLANGE	4	
21	6G1-42716-00-00	RUBBER, SEAL 1	1	
22	6E9-82575-02-00	ENGINE STOP SWITCH ASSY	1	
23	682-82556-00-00	.LANYARD, STOP SWITCH	1	

## Part Notes

8MLHT 1995 / BOTTOM COWLING

PART NUMBER	NOTE TEXT
682-82556-00-00 	OEM: This part number is among the Top 100 Most Popular Marine Maintenance Parts as of March 2014.

©2014 Yamaha Motor Corporation, U.S.A. All rights reserved.



8MLHT 1995 / BRACKET 1

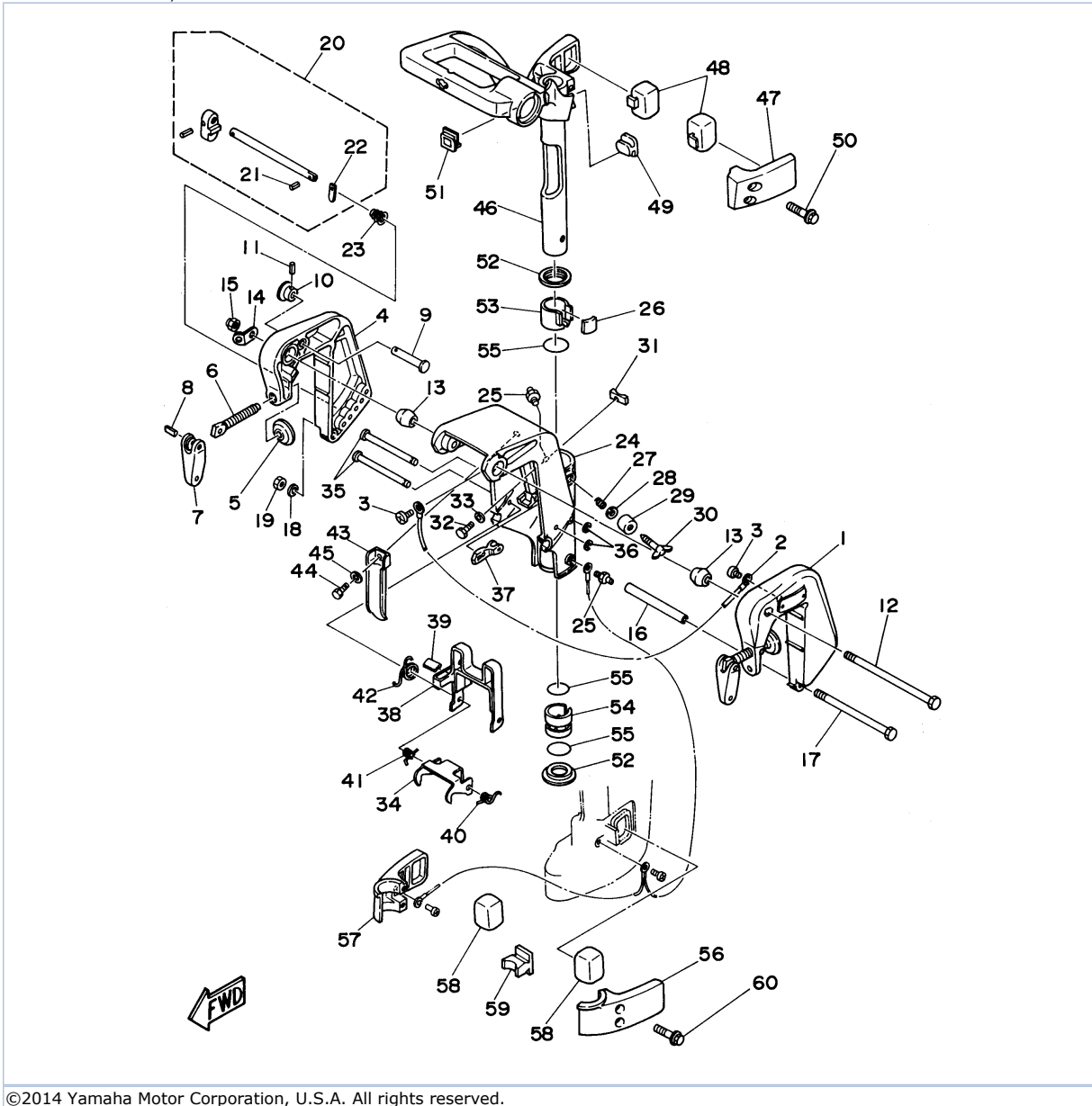

©2014 Yamaha Motor Corporation, U.S.A. All rights reserved.

## Part List



8MLHT 1995 / BRACKET 1

REF - NO	PART NUMBER	PART NAME	QUANTITY	REMARKS
1	6G1-43111-02-4D	BRACKET, CLAMP	1	
2	6E5-82148-00-00	WIRE, LEAD 4	1	
3	98580-06008-00	SCREW, PAN HEAD	2	
4	6G1-43112-01-4D	BRACKET, CLAMP	1	
5	648-43114-01-00	PAD, TRANSOM CLAMP	2	
6	6G1-43116-02-00	SCREW, TRANSOM CLAMP	2	
7	6E0-43118-00-00	HANDLE, TRANSOM CLP	2	
8	90254-04M00-00	PIN, SPRING TYPE	2	
9	689-43191-00-00	SHAFT, STOPPER	1	
10	689-43192-01-00	KNOB, STOPPER	1	
11	91690-30016-00	PIN, SPRING	1	
12	90101-08M08-00	BOLT	1	
13	6G8-43136-00-00	PIECE, FRICTION	2	
14	6A1-43113-01-00	PLATE, CLAMP BRACKET	1	
15	95780-08300-00	..NUT, FLANGE	1	
16	90387-06M13-00	COLLAR	1	
17	97095-06135-00	BOLT	1	
18	92990-06600-00	WASHER, PLATE	1	
19	95601-06200-00	NUT, U-FLANGE	1	
20	6G1-43160-00-00	TILT ROD ASSEMBLY	1	
21	91690-30008-00	.PIN, SPRING	1	
22	689-43165-00-00	.PLATE, TILT LOCK	1	
23	90502-10M06-00	SPRING, CONICAL	1	
24	6G1-43311-13-4D	BRACKET, SWIVEL	1	
25	93700-06M03-00	NIPPLE, GREASE	2	
26	6G1-42528-00-00	PLATE, FRICTION	1	
27	90501-18M00-00	SPRING, COMPRESSION	1	
28	92990-08600-00	..WASHER, PLATE	1	
29	6G1-43373-00-00	SEAL, DAMPER	1	
30	6G1-42529-00-00	SCREW, FRICTION PIECE	1	
31	6G1-44532-00-00	STOPPER, UPPER MOUNT	1	
32	97095-06010-00	BOLT	1	
33	92990-06600-00	WASHER, PLATE	1	
34	6G1-43614-00-00	PLATE, TILT LOCK	1	
35	6G1-43659-00-00	SHAFT, REVERSE LOCK	2	
36	99080-05600-00	CIRCLIP	2	
37	6G1-43615-01-00	PLATE, TILT LOCK	1	
38	6G1-43681-00-00	LEVER, SHALLOW WATER DRIVE 1	1	
39	6G1-43318-01-00	COVER	1	
40	90508-10M15-00	SPRING, TORSION	1	
41	90508-10M16-00	SPRING, TORSION	1	
42	90508-14M17-00	SPRING, TORSION	1	
43	6G1-42731-00-00	CARRYING HANDLE	1	
44	97395-08016-00	BOLT	1	
45	92990-08600-00	..WASHER, PLATE	1	
46	6G1-42511-04-4D	BRACKET, STEERING	1	
47	6G1-44511-00-4D	COVER, UPPER MOUNT	1	
48	6G1-44514-00-00	MOUNT DAMPER, UPPER SIDE	2	
49	6G1-44516-00-00	MOUNT DAMPER, UPPER FRONT	1	
50	95895-06035-00	BOLT, FLANGE	2	
51	6G1-42551-00-00	GROMMET	1	
52	6G1-42535-00-00	WASHER, THRUST	2	
53	6G1-42537-00-00	BUSHING, PIVOT SHAFT	1	
54	6G1-42538-01-00	BUSHING, PIVOT SHAFT	1	
55	93210-30M31-00	O-RING	3	
56	6G1-44551-01-4D	HOUSING, LOWER MOUNT RUBBER	1	
57	6G1-44552-02-4D	HOUSING, LOWER MOUNT RUBBER	1	

58	6G1-44555-A0-00	MOUNT DAMPER, LOWER SIDE	2	
59	6G1-44557-A0-00	MOUNT DAMPER, LOWER FRONT	1	
60	95895-06035-00	BOLT, FLANGE	2	

## Part Notes

8MLHT 1995 / BRACKET 1

PART NUMBER		NOTE TEXT
92990-06600-00		OEM: This part number is among the Top 100 Most Popular Marine Maintenance Parts as of March 2014.
92990-06600-00		OEM: This part number is among the Top 100 Most Popular Marine Maintenance Parts as of March 2014.

©2014 Yamaha Motor Corporation, U.S.A. All rights reserved.

8MLHT 1995 / STEERING

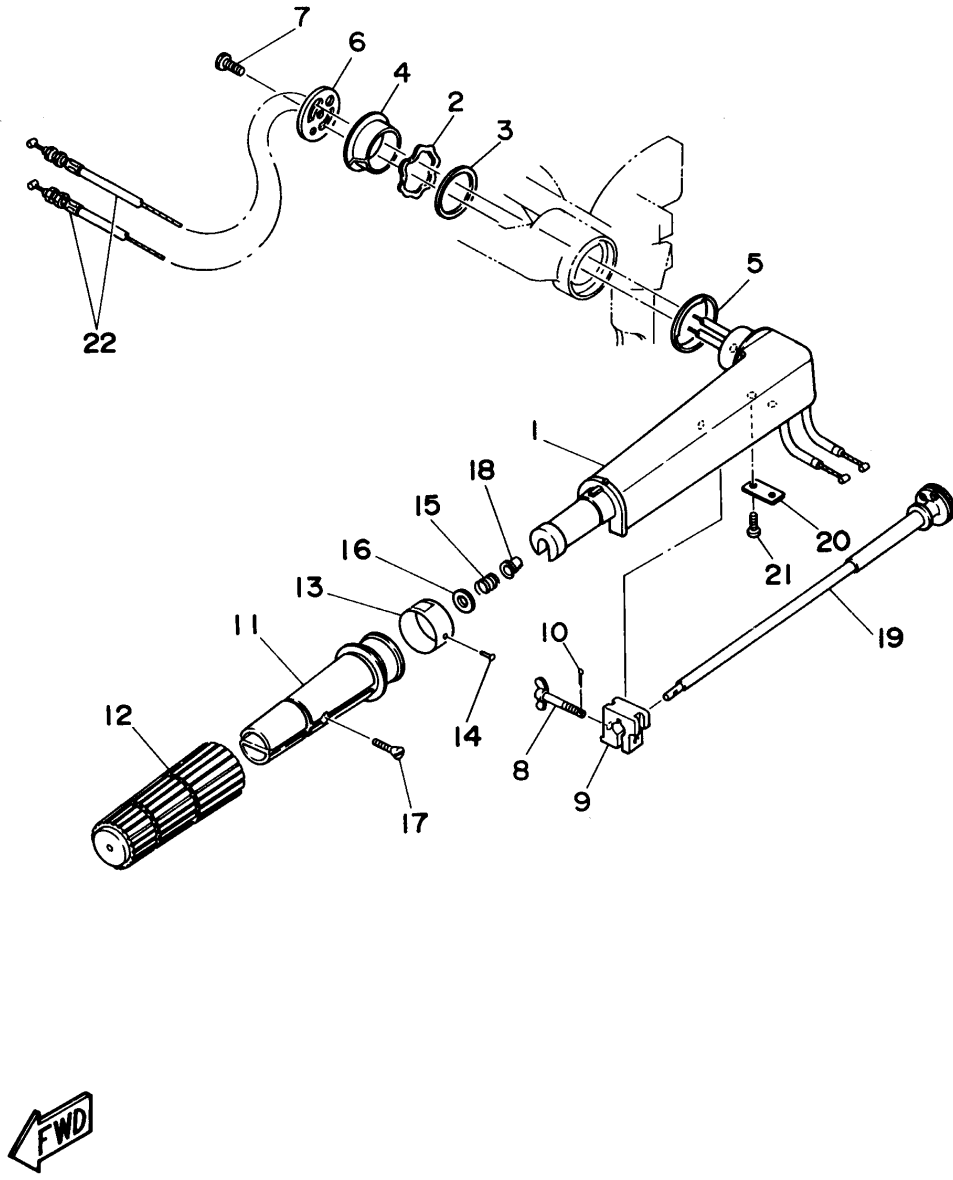

©2014 Yamaha Motor Corporation, U.S.A. All rights reserved.

## Part List

8MLHT 1995 / STEERING

REF - NO	PART NUMBER	PART NAME	QUANTITY	REMARKS
1	6G1-42111-03-4D	HANDLE, STEERING	1	
2	90206-35M20-00	WASHER, WAVE	1	
3	90202-35M24-00	WASHER, PLATE	1	
4	90386-34M40-00	BUSH	1	
5	90386-43M79-00	BUSH	1	
6	6G1-42131-01-00	COVER, HANDLE STEERING	1	
7	97095-06016-00	BOLT	1	
8	6G1-42125-01-00	BOLT, FRICTION ADJUSTING	1	
9	6G1-42126-00-00	FRICTION, STEERING HANDLE GRIP	1	
10	91490-16010-00	PIN. COTTER	1	
11	664-42119-00-00	GRIP, STEERING HANDLE	1	
12	6G1-42177-00-00	RUBBER, HANDLE	1	
13	6G1-42137-10-00	INDICATOR, THROTTLE	1	
14	90269-02M09-00	RIVET	1	
15	90501-23215-00	SPRING, COMPRESSION	1	
16	92990-10600-00	WASHER, PLATE	1	
17	90149-05M13-00	SCREW	1	
18	90386-08032-00	BUSH	1	
19	6G1-42138-01-00	LEVER, THROTTLE	1	
20	6E0-42159-02-00	STAY	1	
21	97895-05012-00	SCREW, PAN HEAD	2	
22	6G1-26301-02-00	THROTTLE CABLE ASSEMBLY	2	

## Part Notes

8MLHT 1995 / STEERING

PART NUMBER	NOTE TEXT
92990-10600-00 	OEM: This part number is among the Top 100 Most Popular Marine Maintenance Parts as of March 2014.

©2014 Yamaha Motor Corporation, U.S.A. All rights reserved.

8MLHT 1995 / CONTROL

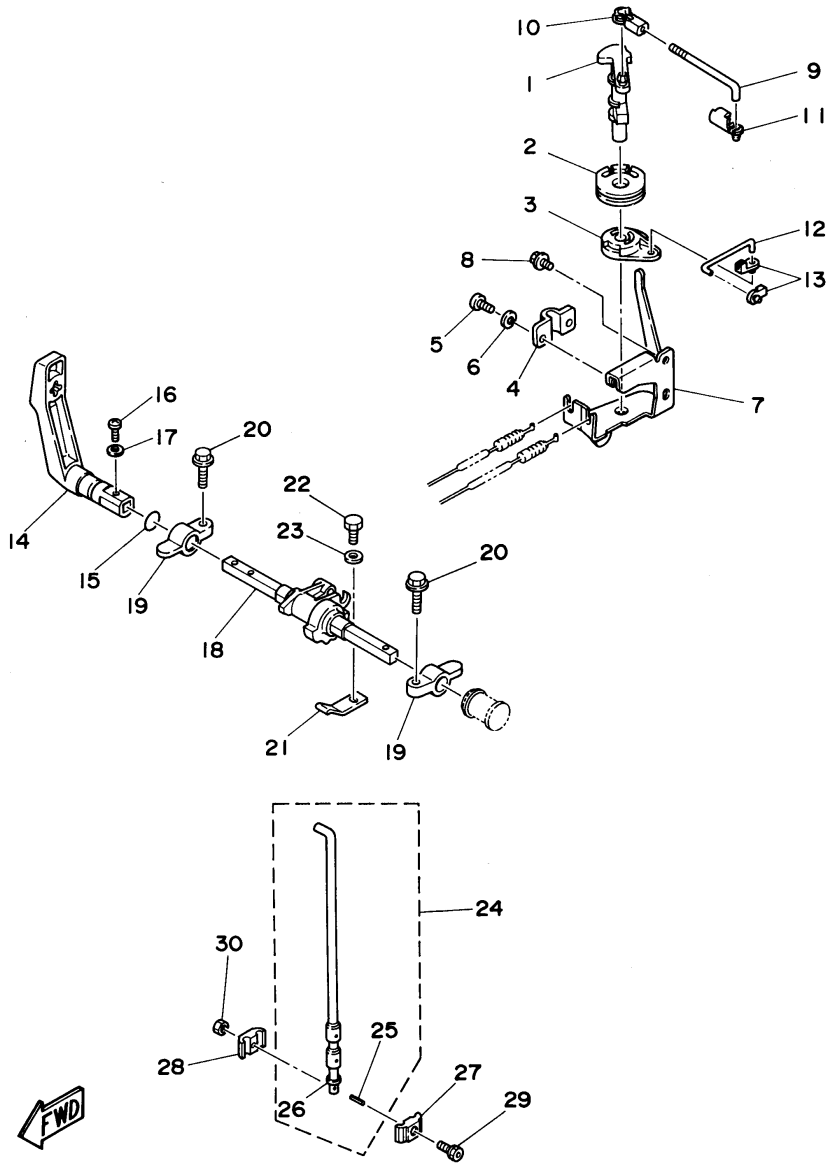

©2014 Yamaha Motor Corporation, U.S.A. All rights reserved.



## Part List

8MLHT 1995 / CONTROL

REF - NO	PART NUMBER	PART NAME	QUANTITY	REMARKS
1	6G1-41631-00-00	LEVER, MAGNETO CONTROL	1	
2	6G1-41638-00-00	PULLEY	1	
3	6G1-41283-01-00	LEVER, FREE ACCEL.	1	
4	6G1-41661-00-00	BRACKET 1	1	
5	98580-05010-00	.SCREW, PAN HEAD	2	
6	92990-05100-00	.WASHER, SPRING	2	
7	6G1-14497-80-00	STAY, THROTTLE WIRE	1	
8	95895-06010-00	BOLT, FLANGE	2	
9	6G1-41238-00-00	JOINT, LINK	1	
10	6H1-41237-00-00	JOINT, LINK	1	
11	6R5-41237-00-00	JOINT, LINK	1	
12	6G1-41211-00-00	LINK, ACCEL.	1	
13	661-41262-02-00	JOINT, CHOKE LEVER	2	
14	6G1-44111-00-00	HANDLE, GEAR SHIFT	1	
15	93210-12790-00	O-RING	1	
16	98580-05016-00	SCREW, PAN HEAD	1	
17	92990-05600-00	WASHER, PLATE	1	
18	6G1-44121-02-94	LEVER, SHIFT ROD	1	
19	6G1-41662-01-94	BRACKET 2	2	
20	97595-06520-00	BOLT, WITH WASHER	2	
21	6G1-44116-01-00	SPRING	1	
22	97095-06012-00	BOLT	1	
23	92990-06600-00	WASHER, PLATE	1	
24	6G1-44110-00-00	SHIFT ROD ASSEMBLY	1	
25	91690-20010-00	.PIN, SPRING	1	
26	92990-05600-00	.WASHER, PLATE	1	
27	6G1-44145-00-00	CONNECTOR, SHIFT ROD	1	
28	6G1-44146-00-00	CONNECTOR, SHIFT ROD	1	
29	90109-06M17-00	BOLT	1	
30	95601-06200-00	NUT, U-FLANGE	1	

## Part Notes

8MLHT 1995 / CONTROL

PART NUMBER		NOTE TEXT
6H1-41237-00-00		OEM: This part number is among the Top 100 Most Popular Marine Maintenance Parts as of March 2014.
92990-06600-00		OEM: This part number is among the Top 100 Most Popular Marine Maintenance Parts as of March 2014.

©2014 Yamaha Motor Corporation, U.S.A. All rights reserved.

8MLHT 1995 / UPPER CASING

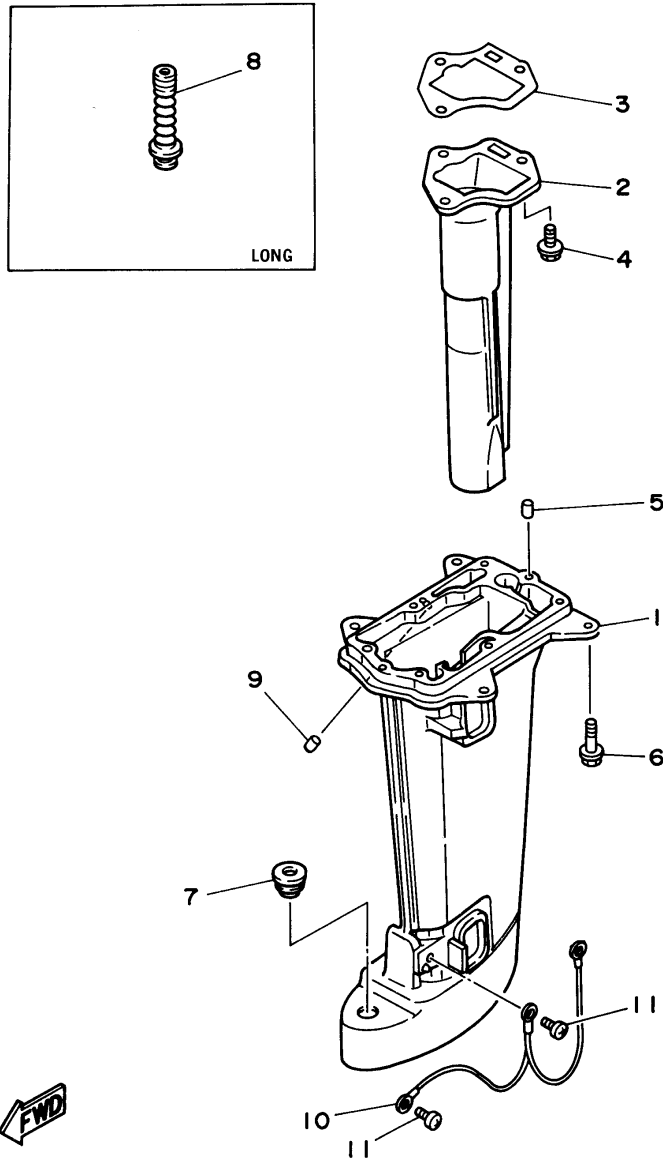

©2014 Yamaha Motor Corporation, U.S.A. All rights reserved.



## Part List

8MLHT 1995 / UPPER CASING

REF - NO	PART NUMBER	PART NAME	QUANTITY	REMARKS
1	6G1-45111-01-4D	CASING, UPPER	1	UR SHORT
1	6G1-45111-11-4D	CASING, UPPER	1	UR LONG
2	6G1-41131-00-5B	MANIFOLD, EXT. 1	1	UR 8MH
2	6H6-41131-00-5B	MANIFOLD, EXT. 1	1	UR 6MH
3	6G1-41133-A0-00	.GASKET, EXHAUST MANIFOLD 1	1	
4	97595-06520-00	BOLT, WITH WASHER	3	
5	93604-08062-00	PIN, DOWEL	2	
6	95895-06030-00	BOLT, FLANGE	6	
7	90480-20M29-00	GROMMET	1	
8	6G1-44147-00-00	.BOOT, SHIFT ROD	1	LONG
9	6G1-45135-00-00	PIPE	1	
10	6G1-82149-00-00	WIRE, LEAD 3	1	
11	98580-06008-00	SCREW, PAN HEAD	2	

8MLHT 1995 / LOWER CASING DRIVE 1

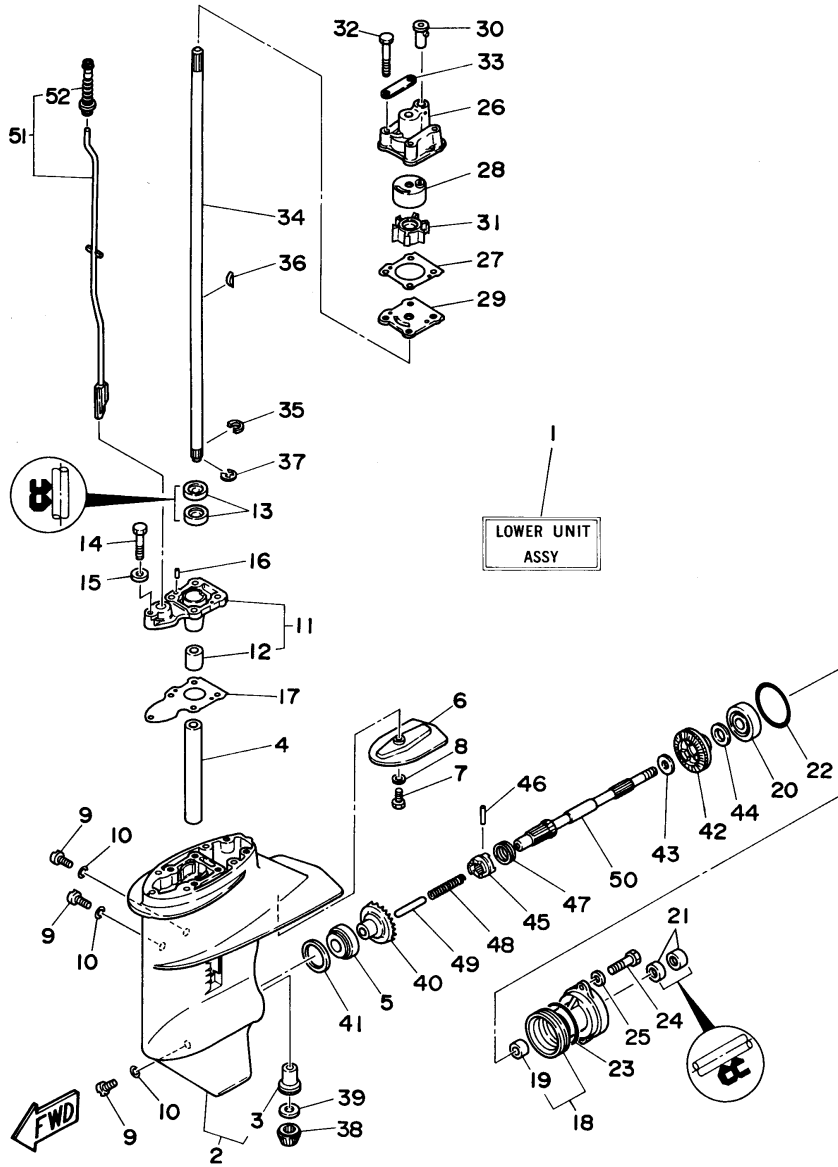

©2014 Yamaha Motor Corporation, U.S.A. All rights reserved.

## Part List



8MLHT 1995 / LOWER CASING DRIVE 1

REF - NO	PART NUMBER	PART NAME	QUANTITY	REMARKS
1	6G1-45300-03-4D	LOWER UNIT ASSEMBLY (REF # 2~52)	1	UR SHORT
1	6G1-45300-13-4D	LOWER UNIT ASSEMBLY (REF. # 2~52)	1	UR LONG
2	6G1-45311-02-4D	CASING, LOWER	1	
3	6G1-45317-09-00	.BUSHING, DRIVE SHAFT	1	
4	90387-14M49-00	COLLAR	1	
5	93332-000U4-00	BEARING	1	
6	6G1-45251-03-00	ANODE	1	
7	97095-06016-00	BOLT	1	
8	92990-06300-00	WASHER, INTERNAL TOOTH	1	
9	90340-08M04-00	PLUG, STRAIGHT SCREW	3	
10	90430-08020-00	.GASKET	3	
11	6G1-45331-01-5B	HOUSING, BEARING	1	
12	6G1-45316-09-00	.BUSHING, DRIVE SHAFT	1	
13	93101-11M23-00	.OIL SEAL	2	
14	97095-06030-00	BOLT	1	
15	92990-06600-00	WASHER, PLATE	1	
16	93604-08062-00	PIN, DOWEL	2	
17	6G1-45315-A0-00	.PACKING, LOWER CASING	1	
18	6G1-45361-01-4D	CAP, LOWER CASING	1	
19	6G1-45362-09-00	.BUSHING	1	
20	93306-00426-00	BEARING	1	
21	93101-15074-00	.OIL SEAL	2	
22	93210-49046-00	.O-RING	1	
23	93210-53679-00	O-RING	1	
24	97095-06016-00	BOLT	2	
25	92990-06600-00	WASHER, PLATE	2	
26	6G1-44311-00-00	HOUSING, WATER PUMP	1	
27	6G1-44315-A0-00	.GASKET, WATER PUMP	1	
28	6G1-44322-00-00	.INSERT, CARTRIDGE	1	
29	6G1-44323-00-00	.OUTER PLATE, CARTRIDGE	1	
30	647-44366-00-00	.DAMPER, WATER SEAL	1	
31	6G1-44352-00-00	.IMPELLER	1	
32	97095-06045-00	.BOLT	4	
33	6G1-44328-00-00	.PLATE	2	
34	6G1-45511-00-00	SHAFT, DRIVE	1	UR SHORT
34	6G1-45511-10-00	SHAFT, DRIVE	1	UR LONG
35	90467-09M05-00	CLIP	1	
36	90280-03024-00	.KEY, WOODRUFF	1	
37	99009-06600-00	CIRCLIP	1	
38	6G1-45551-00-00	PINION	1	
39	6G1-45533-00-19	SHIM (T:1.9MM)	1	UR
39	6G1-45533-00-20	SHIM (T:2.0MM)	1	UR
39	6G1-45533-00-21	SHIM (T:2.1MM)	1	UR
39	6G1-45533-00-22	SHIM (T:2.2MM)	1	UR
40	6G1-45560-00-00	GEAR	1	
41	664-45587-01-10	SHIM (T:0.10MM)	1	UR
41	664-45587-01-40	SHIM (T:0.40MM)	1	UR
41	664-45587-01-15	SHIM (T:0.15MM)	1	UR
41	664-45587-01-18	SHIM (T:0.18MM)	1	UR
41	664-45587-01-12	SHIM (T:0.12MM)	1	UR
41	664-45587-01-30	SHIM (T:0.30MM)	1	UR
41	664-45587-01-50	SHIM (T:0.50MM)	1	UR
42	6G1-45571-00-00	GEAR	1	
43	90201-15M89-00	WASHER, PLATE	1	
44	647-45567-00-00	SHIM (T:0.10MM)	1	UN
45	6G1-45631-00-00	CLUTCH, DOG	1	
46	6G1-45632-00-00	PIN, CROSS	1	
47	654-45633-00-00	RING, CROSS PIN	1	
48	90501-12M38-00	SPRING, COMPRESSION	1	

49	6G1-45635-00-00	PLUNGER, SHIFT	1	
50	6G1-45611-01-00	SHAFT, PROPELLER	1	
51	6G1-44150-11-00	SHIFT CAM ASSEMBLY	1	UR LONG
51	6G1-44150-01-00	SHIFT CAM ASSEMBLY	1	UR SHORT
52	6G1-44147-00-00	.BOOT, SHIFT ROD	1	

## Part Notes

8MLHT 1995 / LOWER CASING DRIVE 1

PART NUMBER		NOTE TEXT
90430-08020-00		OEM: This part number is among the Top 100 Most Popular Marine Maintenance Parts as of March 2014.
92990-06600-00		OEM: This part number is among the Top 100 Most Popular Marine Maintenance Parts as of March 2014.
92990-06600-00		OEM: This part number is among the Top 100 Most Popular Marine Maintenance Parts as of March 2014.

©2014 Yamaha Motor Corporation, U.S.A. All rights reserved.



## Part List

8MLHT 1995 / LOWER CASING DRIVE 2

REF - NO	PART NUMBER	PART NAME	QUANTITY	REMARKS
1	93604-08062-00	PIN, DOWEL	2	
2	95895-06030-00	BOLT, FLANGE	4	
3	6G1-45214-00-00	COVER, WATER INLET 1	1	
4	6G1-45215-00-00	COVER, WATER INLET 2	1	
5	98180-05020-00	SCREW, OVAL HEAD	1	
6	90185-05002-00	NUT, NYLON	1	
7	6G1-44361-10-00	TUBE, WATER	1	UR LONG
7	6G1-44361-00-00	TUBE, WATER	1	UR SHORT
8	6G1-44365-00-00	DAMPER, WATER SEAL	1	
9	6G1-45987-02-00	SPACER 1	1	
10	90201-10M01-00	WASHER, PLATE	1	
11	90171-10M01-00	NUT, CASTLE	1	
12	91490-30020-00	PIN. COTTER	1	
13	6G1-45947-00-EL	PROPELLER (3X8-1/2"X6-1/2"-N)	1	UR
13	6G1-45943-00-EL	PROPELLER (3X8-1/2"X7-1/2"-N)	1	UR
13	6G1-W4591-01-EL	PROPELLER (3X9"X7"-N)	1	UR DUAL THRUST
14	6G1-45981-00-00	.DAMPER, PROPELLER	1	
15	6G1-45986-00-94	.RING, DEFLECTOR	1	
16	6G1-45616-01-00	.NUT, PROPELLER	1	
17	90201-10M02-00	.WASHER, PLATE	1	

8MLHT 1995 / GENERATOR

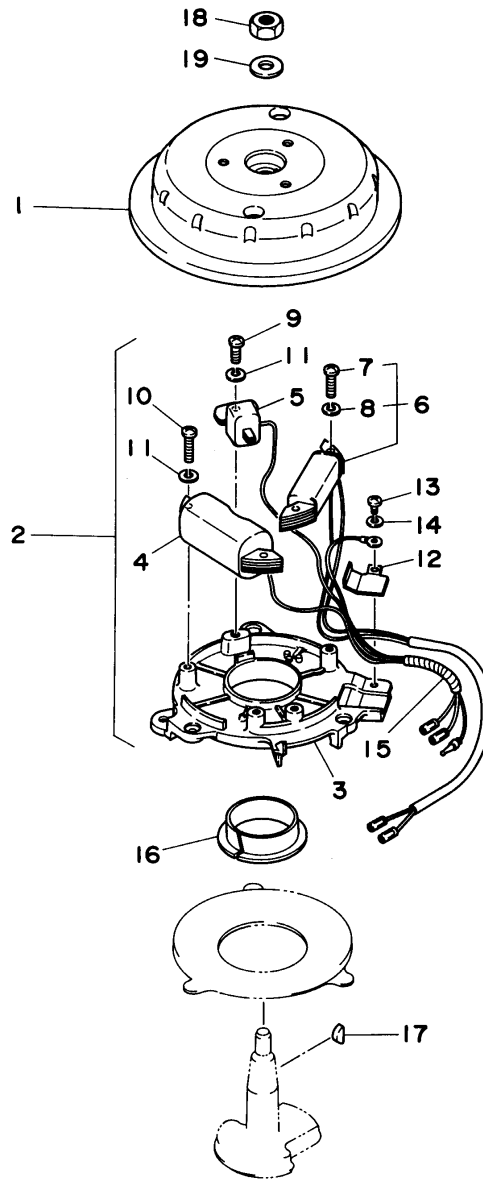

©2014 Yamaha Motor Corporation, U.S.A. All rights reserved.

## Part List

8MLHT 1995 / GENERATOR

REF - NO	PART NUMBER	PART NAME	QUANTITY	REMARKS
1	6G1-85550-71-00	ROTOR ASSEMBLY	1	
2	6G1-85560-F0-00	BASE ASSY	1	
3	6G1-85509-70-00	.BASE, MAGNETO	1	
4	6E7-85520-70-00	.COIL, CHARGE	1	
5	6E7-85580-70-00	.COIL, PULSER	1	
6	6E7-81303-A0-00	.LIGHTING COIL ASSY	1	
7	98580-05525-00	..SCREW, PAN HEAD	2	
8	92990-05100-00	..WASHER, SPRING	2	
9	98580-05016-00	.SCREW, PAN HEAD	1	
10	98511-05020-00	.SCREW, PAN HEAD	2	
11	92990-05100-00	.WASHER, SPRING	3	
12	6G1-85548-70-00	.HOLDER	1	
13	98580-04008-00	.SCREW, PAN HEAD	1	
14	92990-04100-00	.WASHER, SPRING	1	
15	6G1-85515-70-00	.LEAD WIRE ASSY	1	
16	90386-44M42-00	BUSH	1	
17	90280-04M06-00	KEY, WOODRUFF	1	
18	90170-10113-00	NUT	1	
19	90201-102G9-00	WASHER, PLATE	1	



8MLHT 1995 / ELECTRICAL

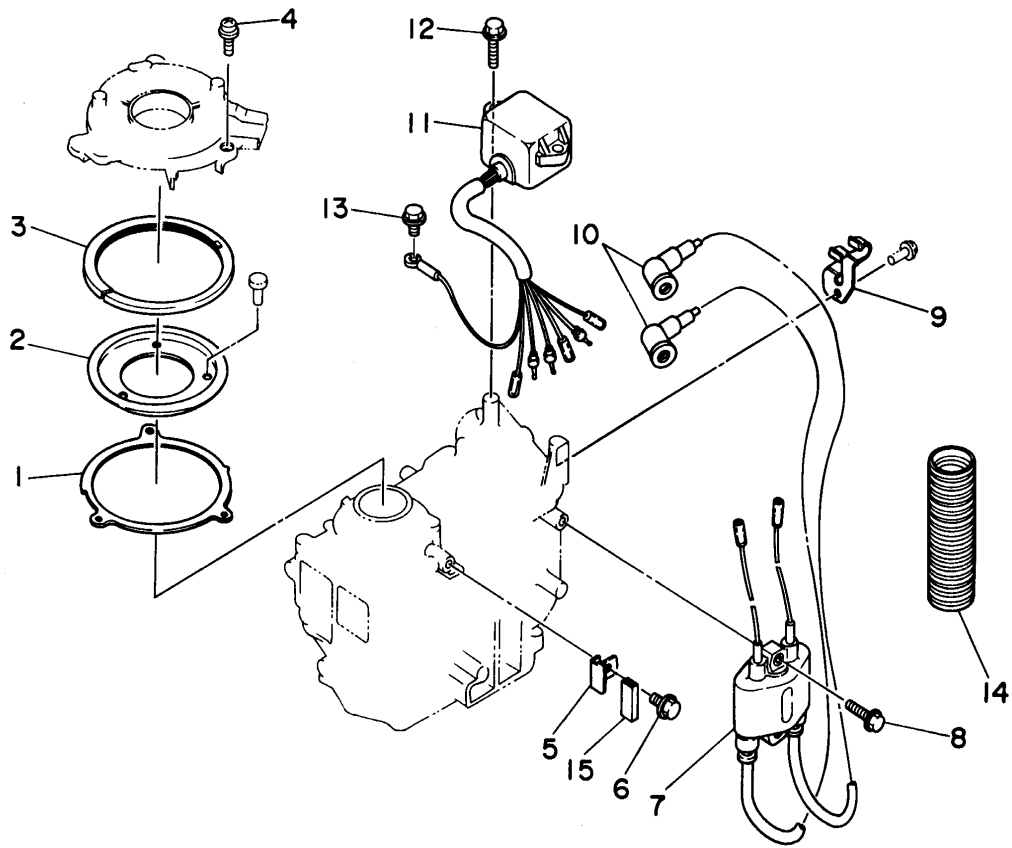

©2014 Yamaha Motor Corporation, U.S.A. All rights reserved.

## Part List

8MLHT 1995 / ELECTRICAL

REF - NO	PART NUMBER	PART NAME	QUANTITY	REMARKS
1	6G1-41611-00-00	RETAINER, MAGNETO BASE	1	
2	6G1-41612-00-00	RETAINER, MAGNETO BASE	1	
3	695-41613-00-00	PLATE, BASE FRICTION	1	
4	97985-05210-00	SCREW, WITH WASHER	3	
5	6G1-41615-00-00	STOPPER, MAGNETO BASE	1	
6	95895-06010-00	BOLT, FLANGE	1	
7	6G1-85570-00-00	IGNITION COIL ASSEMBLY	1	
8	95895-06025-00	BOLT, FLANGE	2	
9	90465-08M17-00	CLAMP	1	
10	663-82370-01-00	PLUG CAP ASSY	2	
11	696-85540-11-00	C.D.I. UNIT ASSY	1	
12	95895-06020-00	BOLT, FLANGE	2	
13	95895-06010-00	BOLT, FLANGE	1	
14	6G1-83557-00-00	TUBE	1	
15	6G1-44194-00-00	CAP	1	

8MLHT 1995 / REPAIR KIT

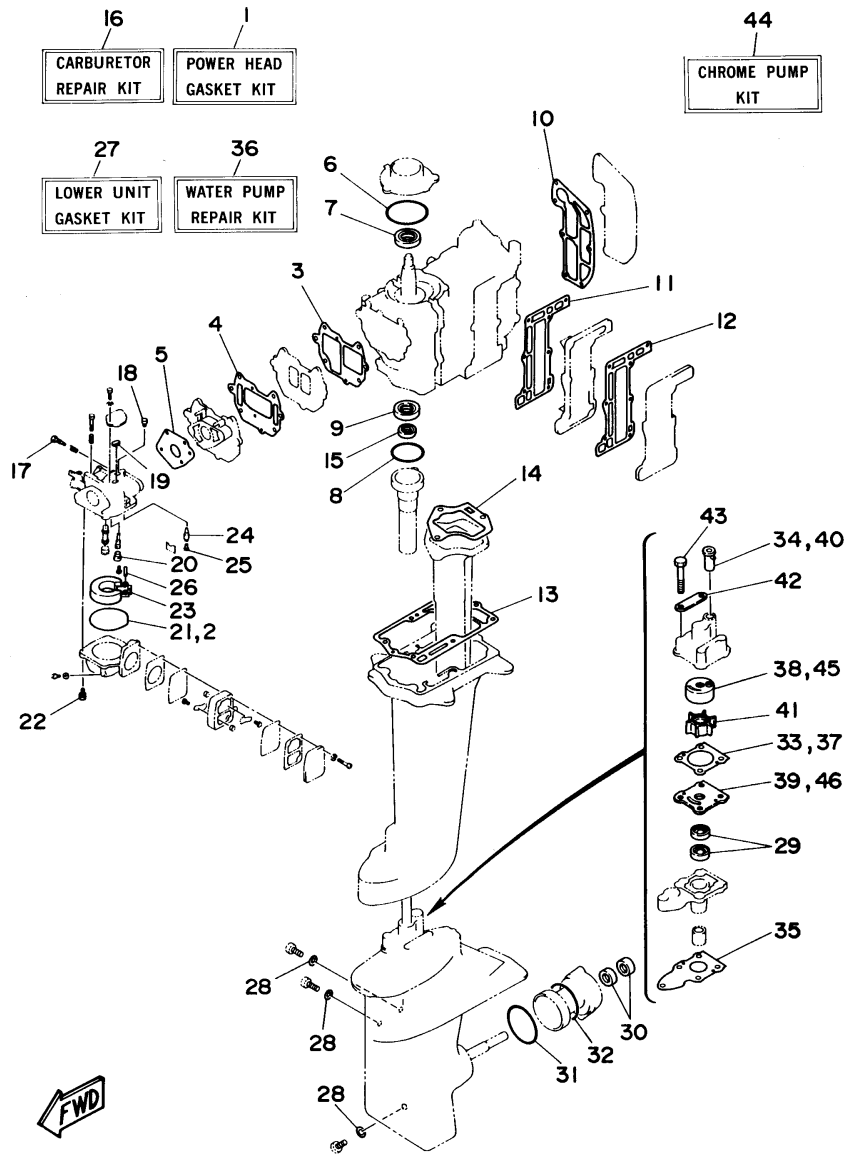

©2014 Yamaha Motor Corporation, U.S.A. All rights reserved.

## Part List

8MLHT 1995 / REPAIR KIT

REF - NO	PART NUMBER	PART NAME	QUANTITY	REMARKS
1	6G1-W0001-02-00	POWER HEAD GASKET KIT	1	
2	6G1-14984-00-00	.O-RING	1	
3	6G1-13621-A1-00	.GASKET, VALVE SEAT	1	
4	6G1-13645-A1-00	.GASKET, MANIFOLD 1	1	
5	6G1-14198-A1-00	.GASKET	1	
6	93210-54M54-00	.O-RING	1	
7	93102-20M25-00	.OIL SEAL	1	
8	93210-42159-00	.O-RING	1	
9	93101-20M29-00	.OIL SEAL	1	
10	6G1-11193-A1-00	.GASKET, HEAD COVER 1	1	
11	6G1-41112-A1-00	.GASKET, EXHAUST INNER COVER	1	
12	6G1-41114-A0-00	.GASKET, EXHAUST OUTER COVER	1	
13	6G1-45113-A1-00	.GASKET, UPPER CASING	1	
14	6G1-41133-A0-00	.GASKET, EXHAUST MANIFOLD 1	1	
15	93101-12M26-00	.OIL SEAL	1	
16	6G1-W0093-00-00	CARBURETOR REPAIR KIT	1	
17	679-14923-00-00	.SCREW, PILOT	1	
18	6G1-14966-00-00	.CAP	1	
19	6G1-14126-00-00	.GASKET	1	
20	676-14966-00-00	.CAP	1	
21	6G1-14984-00-00	.O-RING	1	
22	97980-04114-00	.SCREW, WITH WASHER	1	
23	6G1-14985-00-00	.FLOAT	1	
24	6G1-14546-00-00	.VALVE, NEEDLE	1	
25	676-14186-00-00	.PIN, FLOAT	1	
26	688-14548-00-00	.PIN, FLOAT ARM	1	
27	6G1-W0001-21-00	LOWER UNIT GASKET KIT	1	
28	90430-08020-00	.GASKET	3	
29	93101-11M23-00	.OIL SEAL	2	
30	93101-15074-00	.OIL SEAL	2	
31	93210-49046-00	.O-RING	1	
32	93210-53679-00	.O-RING	1	
33	6G1-44315-A0-00	.GASKET, WATER PUMP	1	
34	647-44366-00-00	.DAMPER, WATER SEAL	1	
35	6G1-45315-A0-00	.PACKING, LOWER CASING	1	
36	6G1-W0078-01-00	WATER PUMP REPAIR KIT	1	
37	6G1-44315-A0-00	.GASKET, WATER PUMP	1	
38	6G1-44322-00-00	.INSERT, CARTRIDGE	1	
39	6G1-44323-00-00	.OUTER PLATE, CARTRIDGE	1	
40	647-44366-00-00	.DAMPER, WATER SEAL	1	
41	6G1-44352-00-00	.IMPELLER	1	
42	6G1-44328-00-00	.PLATE	2	
43	97095-06045-00	.BOLT	4	
44	6G1-W0078-0A-00	CHROME PUMP KIT	1	
45	6G1-44322-40-00	.INSERT, CARTRIDGE	1	
46	6G1-44323-40-00	.OUTER PLATE, CARTRIDGE	1	

## Part Notes

8MLHT 1995 / REPAIR KIT

PART NUMBER	NOTE TEXT
90430-08020-00 	OEM: This part number is among the Top 100 Most Popular Marine Maintenance Parts as of March 2014.

©2014 Yamaha Motor Corporation, U.S.A. All rights reserved.

©2014 Yamaha Motor Corporation, U.S.A. All rights reserved.