

P60TLHP 1991 / CYLINDER CRANKCASE

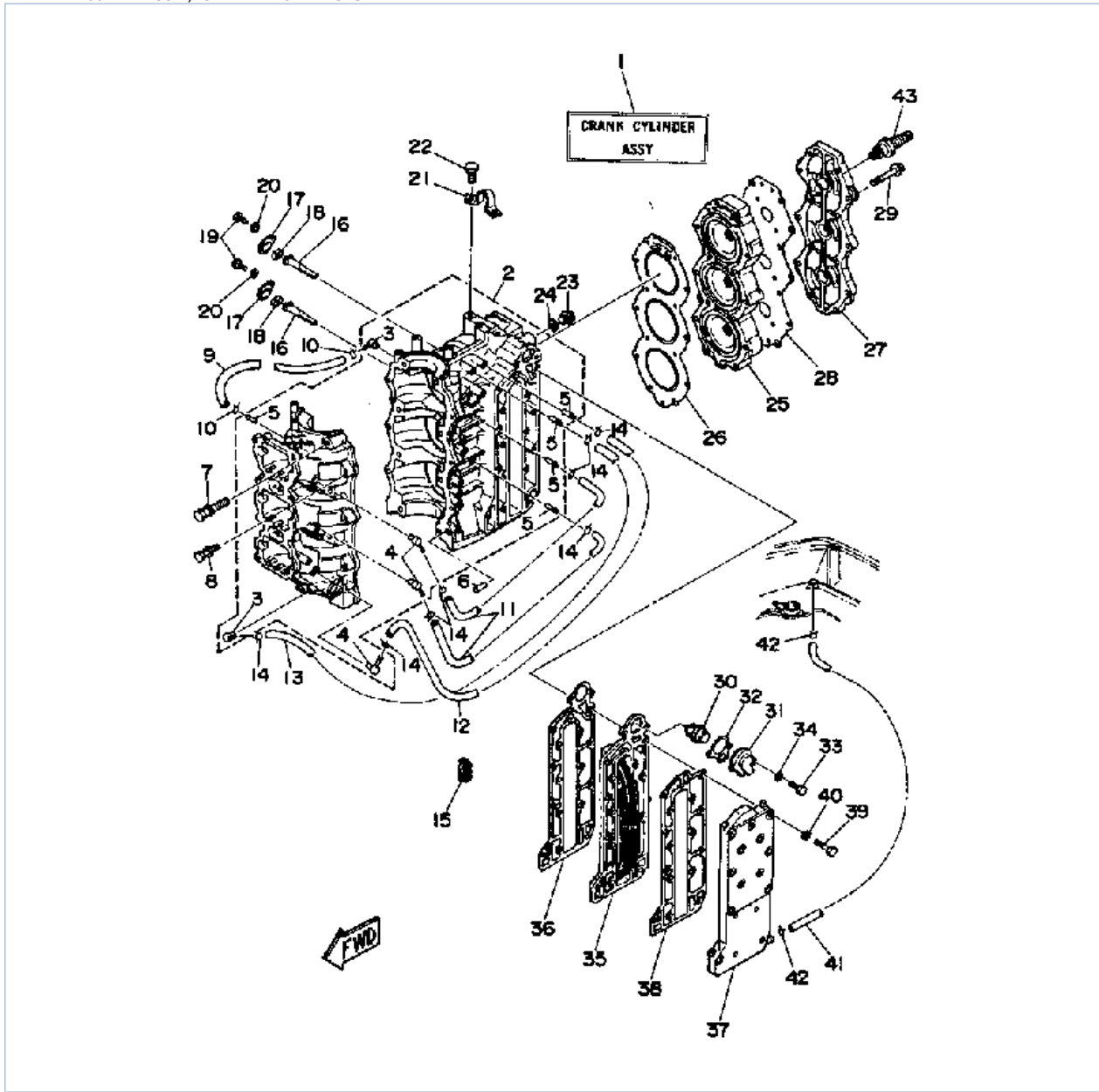

©2014 Yamaha Motor Corporation, U.S.A. All rights reserved.



Part List

P60TLHP 1991 / CYLINDER CRANKCASE

REF - NO	PART NUMBER	PART NAME	QUANTITY	REMARKS
1	6H3-W0090-40-EK	CRANK CYLINDER ASSY	1	
2	6H3-15100-12-94	CRANKCASE ASSEMBLY	1	
3	688-11370-00-00	.CHECK VALVE ASSY	2	
4	650-11370-00-00	.CHECK VALVE ASSY	3	
5	624-14485-00-00	.PIPE, JOINT	5	
6	93608-12063-00	PIN, DOWEL	2	
7	90119-10M07-00	BOLT, WITH WASHER	8	
8	90119-08M17-00	BOLT, WITH WASHER	6	
9	90445-07M44-00	HOSE (L250)	1	
10	90467-06016-00	CLIP	2	
11	90445-07M02-00	HOSE (L167)	2	
12	90445-07M45-00	HOSE (L340)	1	
13	90445-07M82-00	HOSE (L440)	1	
14	90467-06016-00	CLIP	8	
15	90464-07M05-00	CLAMP	1	
16	6H3-11325-00-00	ANODE	2	
17	6H3-11327-00-94	COVER, ANODE	2	
18	6H3-11328-00-00	GROMMET, ANODE	2	
19	97313-06016-00	BOLT, HEXAGON	2	
20	92990-06600-00	WASHER, PLATE	2	
21	688-11119-00-00	HANGER, ENGINE	1	
22	97313-08020-00	BOLT, HEXAGON	2	
23	90340-14M00-00	.PLUG, STRAIGHT SCREW	1	
24	90430-14115-00	.GASKET	1	
25	6H3-11111-01-94	HEAD, CYLINDER 1	1	
26	6H3-11181-A0-00	GASKET, CYLINDER HEAD 1	1	
27	6H3-11191-00-9M	COVER, CYLINDER HEAD 1	1	
28	6H3-11193-A1-00	GASKET, HEAD COVER 1	1	
29	90119-08M09-00	BOLT, WITH WASHER	14	
30	6H3-12411-10-00	THERMOSTAT	1	
31	6H3-12413-00-9M	COVER, THERMOSTAT	1	
32	6H3-12414-A1-00	GASKET, COVER	1	
33	97313-06025-00	BOLT	2	
34	92990-06600-00	WASHER, PLATE	2	
35	6H3-41111-00-9M	INNER COVER, EXHAUST	1	
36	6H3-41112-01-00	GASKET, EXHAUST	1	
37	6H3-41113-00-9M	OUTER COVER, EXHAUST	1	
38	6H3-41114-A0-00	GASKET, EXHAUST OUTER COVER	1	
39	97013-06035-00	BOLT	16	
40	92990-06600-00	WASHER, PLATE	16	
41	663-24312-01-00	PIPE 2	1	
42	90467-08004-00	CLIP	2	
43	94701-00160-00	PLUG, SPARK	3	

Part Notes

P60TLHP 1991 / CYLINDER CRANKCASE

PART NUMBER	NOTE TEXT
92990-06600-00 	OEM: This part number is among the Top 100 Most Popular Marine Maintenance Parts as of March 2014.
92990-06600-00 	OEM: This part number is among the Top 100 Most Popular Marine Maintenance Parts as of March 2014.
92990-06600-00 	OEM: This part number is among the Top 100 Most Popular Marine Maintenance Parts as of March 2014.

©2014 Yamaha Motor Corporation, U.S.A. All rights reserved.

P60TLHP 1991 / CRANK PISTON

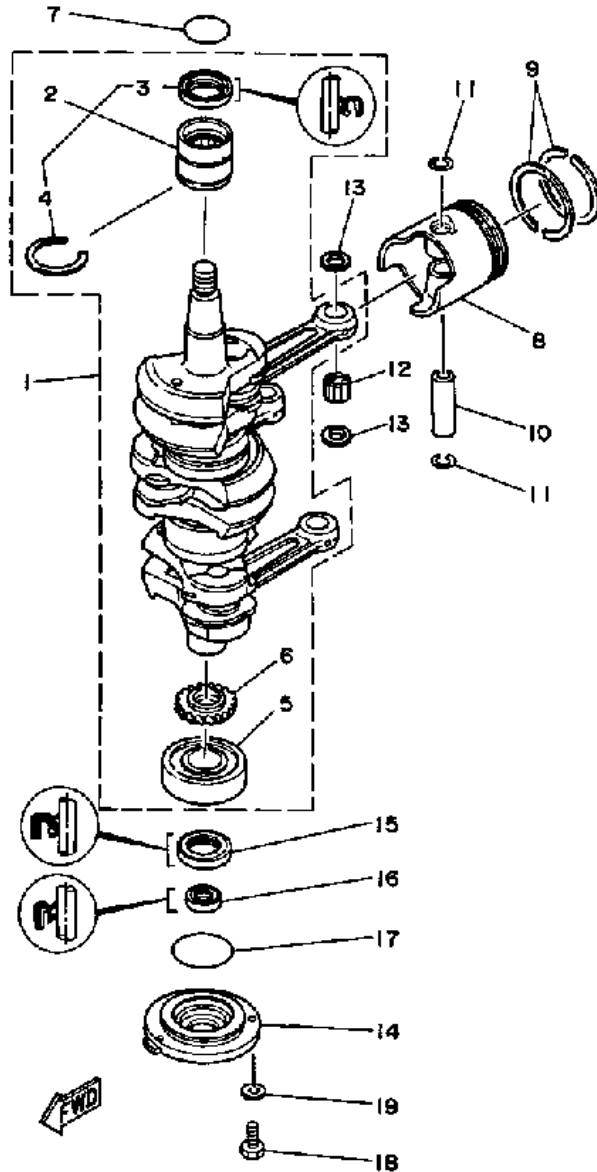

©2014 Yamaha Motor Corporation, U.S.A. All rights reserved.

Part List

P60TLHP 1991 / CRANK PISTON

REF - NO	PART NUMBER	PART NAME	QUANTITY	REMARKS
1	6H3-11400-11-00	CRANKSHAFT ASSY	1	
2	93311-636U6-00	.BEARING	1	
3	93102-36M24-00	..OIL SEAL	1	
4	93440-49M04-00	..CIRCLIP	1	
5	93306-306V1-00	.BEARING	1	
6	6H3-11536-00-00	.GEAR, DRIVE	1	
7	93210-46M16-00	.O-RING	1	
8	6H3-11636-01-00	PISTON (0.50MM O.S.)	3	AP
8	6H3-11631-01-96	PISTON (STD)	3	
9	6K5-11601-02-00	PISTON RING SET (STD)	3	
9	6K5-11601-22-00	PISTON RING SET (0.50MM O.S.)	3	AP
10	6H3-11633-00-00	PIN, PISTON	3	
11	688-11634-10-00	CLIP, PISTON PIN	6	
12	93603-18M09-00	PIN, DOWEL	84	
13	90201-20417-00	WASHER, PLATE	6	
14	6H3-15359-00-94	HOUSING, OIL SEAL	1	
15	93102-30M23-00	OIL SEAL	1	
16	93106-18M01-00	OIL SEAL	1	
17	93210-65M50-00	.O-RING	1	
18	97395-06020-00	BOLT, HEXAGON	3	
19	92990-06600-00	WASHER, PLATE	3	

Part Notes

P60TLHP 1991 / CRANK PISTON

PART NUMBER	NOTE TEXT
92990-06600-00 	OEM: This part number is among the Top 100 Most Popular Marine Maintenance Parts as of March 2014.

©2014 Yamaha Motor Corporation, U.S.A. All rights reserved.

P60TLHP 1991 / INTAKE

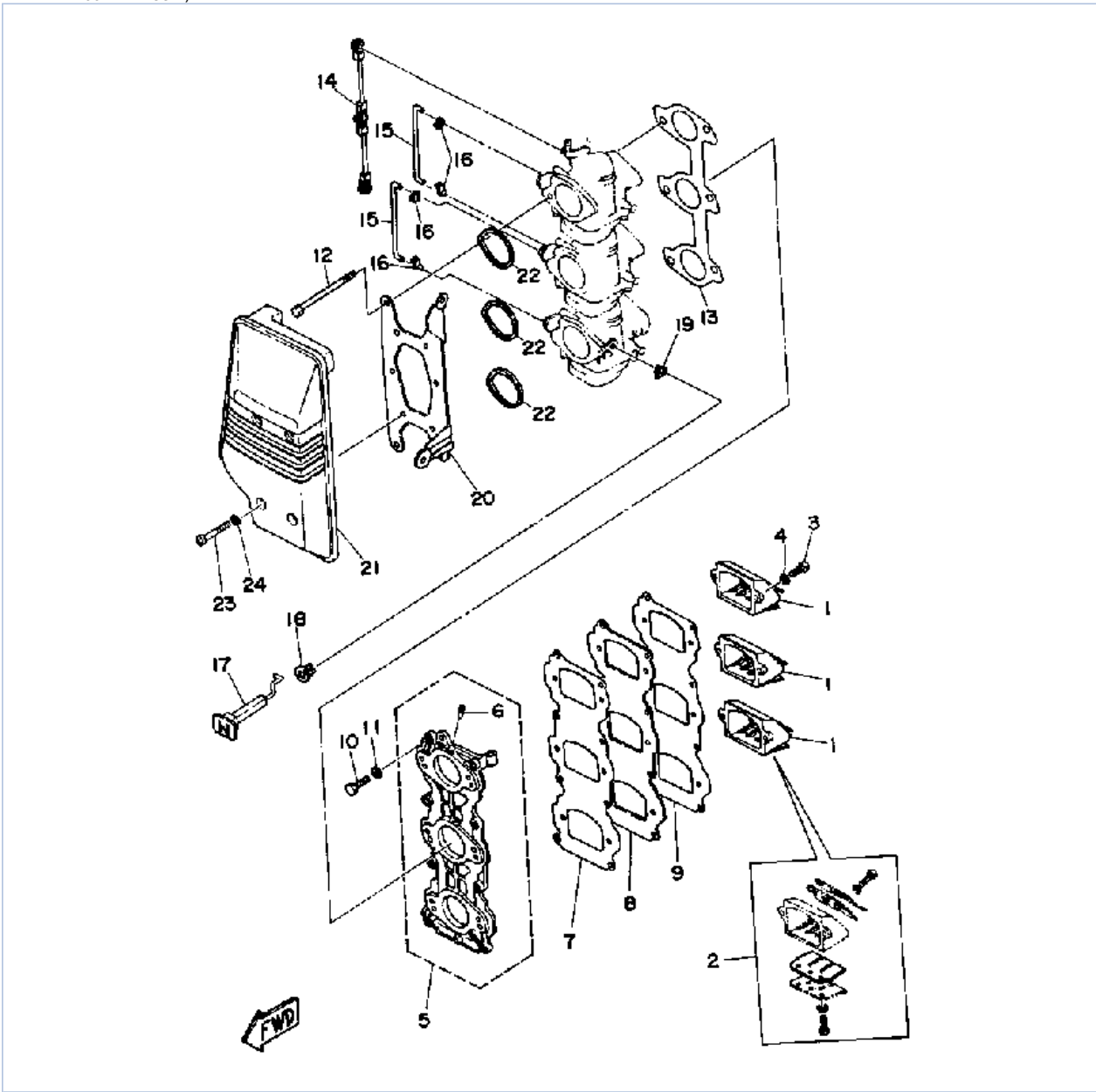

©2014 Yamaha Motor Corporation, U.S.A. All rights reserved.

Part List

P60TLHP 1991 / INTAKE

REF - NO	PART NUMBER	PART NAME	QUANTITY	REMARKS
1	6H2-13610-00-00	REED VALVE ASSY	3	
2	688-W0004-00-00	.REED SET	1	
3	98580-05020-00	.SCREW, PAN HEAD	6	
4	92990-05100-00	.WASHER, SPRING	6	
5	6H3-13641-11-94	MANIFOLD 1	1	
6	6H1-14485-00-00	.PIPE, JOINT	3	
7	6H3-13621-00-00	GASKET, VALVE SEAT	1	
8	6H3-13624-00-94	PLATE, REED VALVE	1	
9	6H3-13622-00-00	PACKING, VALVE SEAT	1	
10	97313-06025-00	BOLT	8	
11	92990-06600-00	WASHER, PLATE	8	
12	97313-06095-00	BOLT, HEXAGON	6	
13	6H3-14198-01-00	GASKET	1	
14	6H3-41217-00-00	ROD, ACCEL. LEVER	1	
15	6H3-41257-00-00	ROD, CHOKE 2	2	
16	661-41262-02-00	JOINT, CHOKE LEVER	4	
17	6H3-41271-00-00	KNOB, CHOKE	1	
18	689-41273-00-00	GROMMET	1	
19	661-41262-02-00	JOINT, CHOKE LEVER	1	
20	6H3-14413-10-00	STAY	1	
21	6H3-14440-02-00	SILENCER ASSY, INTAKE	1	
22	6H3-14457-01-00	SEAL	3	
23	97895-06045-00	SCREW, PAN HEAD	4	
24	90209-06M05-00	WASHER	4	

Part Notes

P60TLHP 1991 / INTAKE

PART NUMBER	NOTE TEXT
92990-06600-00 	OEM: This part number is among the Top 100 Most Popular Marine Maintenance Parts as of March 2014.

©2014 Yamaha Motor Corporation, U.S.A. All rights reserved.

P60TLHP 1991 / CARBURETOR

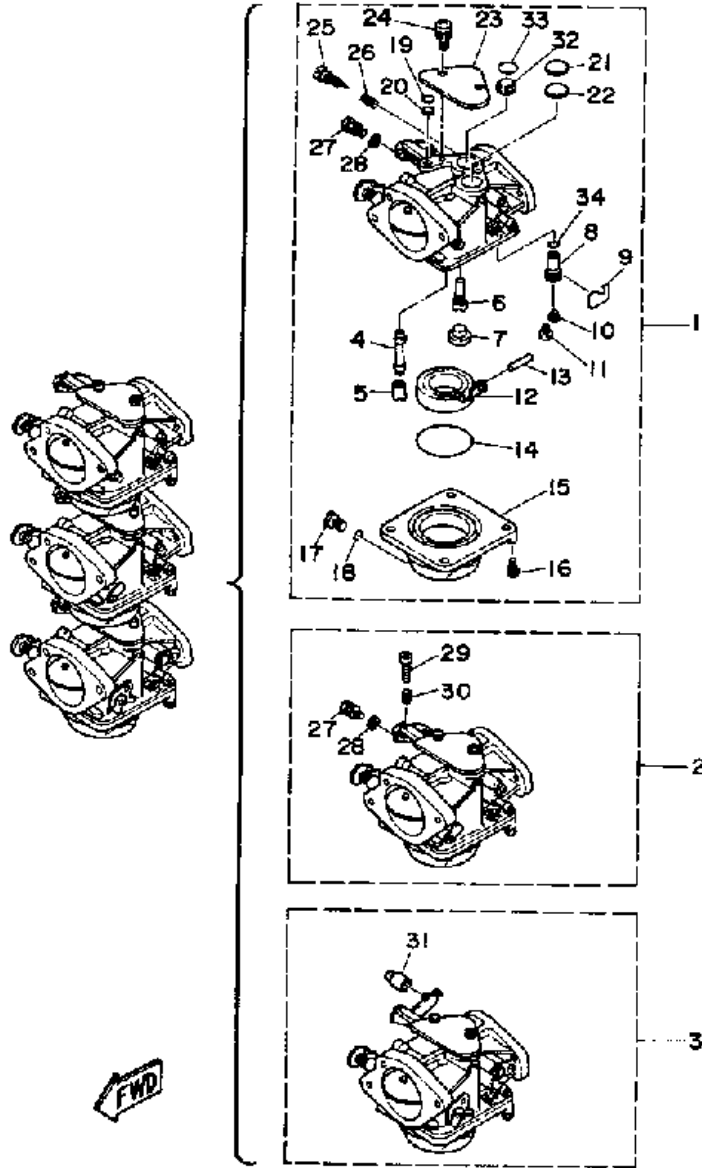

©2014 Yamaha Motor Corporation, U.S.A. All rights reserved.

Part List

P60TLHP 1991 / CARBURETOR

REF - NO	PART NUMBER	PART NAME	QUANTITY	REMARKS
1	6H2-14301-08-00	CARBURETOR ASSEMBLY 1	1	
2	6H2-14302-08-00	CARBURETOR ASSEMBLY 2	1	
3	6H2-14303-08-00	CARBURETOR (LOWER)	1	
4	6H2-14947-02-00	.NOZZLE, MAIN	3	
5	676-14943-36-00	.JET, MAIN (145)	1	UR
5	676-14943-35-00	.JET, MAIN (140)	2	UR
6	6H2-14948-15-00	.JET (#70)	3	
7	676-14966-00-00	.CAP	3	
8	6H3-14590-00-00	.NEEDLE VALVE ASSEMBLY	3	
9	663-14159-00-00	.CLIP	3	
10	676-14186-00-00	.PIN, FLOAT	3	
11	98580-04008-00	.SCREW, PAN HEAD	3	
12	6G1-14985-00-00	.FLOAT	3	
13	688-14548-00-00	.PIN, FLOAT ARM	3	
14	6G1-14984-00-00	.O-RING	3	
15	6H2-14980-00-00	.BODY, FLOAT CHAMBER	3	
16	97980-04114-00	.SCREW, WITH WASHER	12	
17	6H3-14992-00-00	.SCREW, DRAIN	3	
18	93210-04230-00	.O-RING	3	
19	663-14126-00-00	.GASKET	3	
20	663-14527-00-00	.PLATE	3	
21	688-14126-00-00	.GASKET	3	
22	688-14527-00-00	.PLATE	3	
23	6H2-14527-01-00	.PLATE	3	
24	97980-05310-00	.SCREW, WITH WASHER	6	
25	692-14923-00-00	.SCREW, PILOT	3	
26	679-14555-00-00	.SPRING	3	
27	663-14592-00-00	.SCREW	2	
28	90201-05652-00	.WASHER, PLATE	2	
29	663-14523-00-00	.SCREW, STOP	1	
30	90501-10326-00	.SPRING, COMPRESSION	1	
31	6H2-14578-00-00	.COLLAR	1	
32	6H3-14578-00-00	.PLATE	3	
33	93210-15M52-00	.O-RING	3	
34	93210-04228-00	.O-RING	3	

P60TLHP 1991 / FUEL SYSTEM

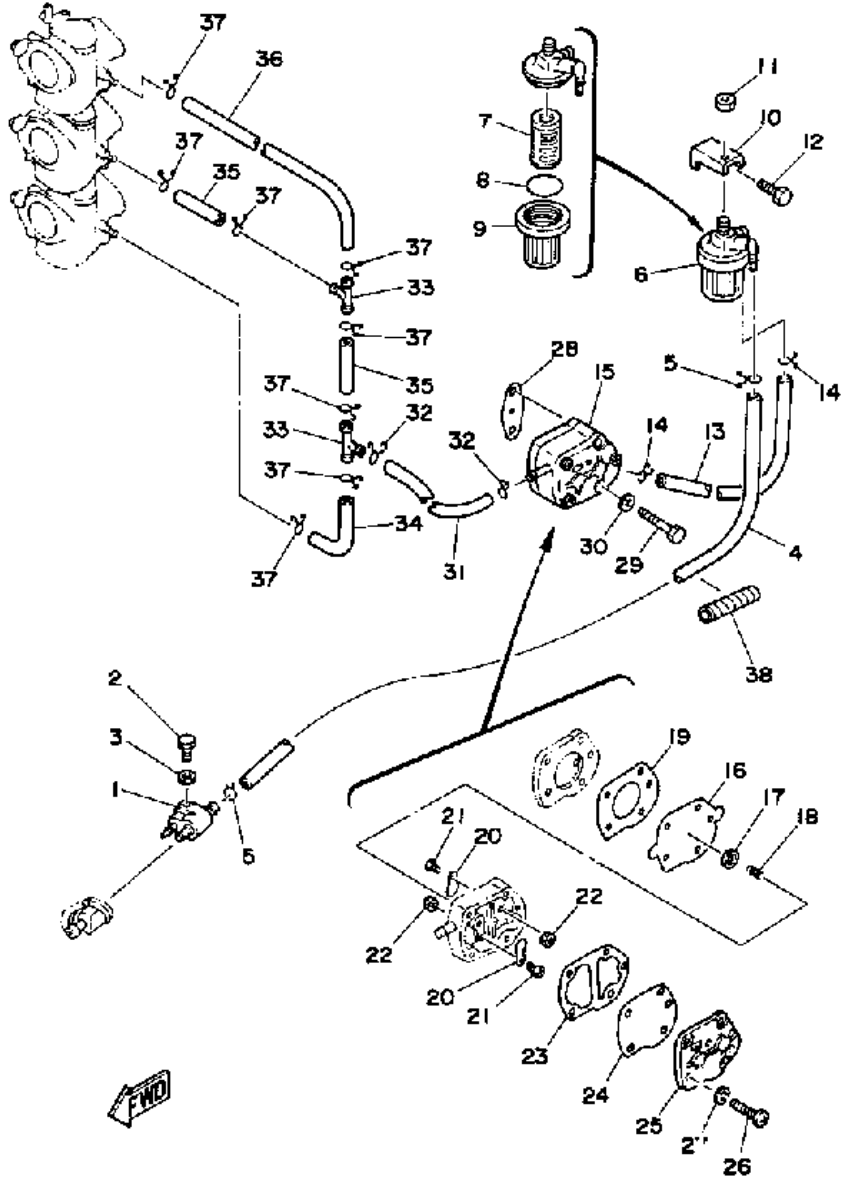

©2014 Yamaha Motor Corporation, U.S.A. All rights reserved.



Part List

P60TLHP 1991 / FUEL SYSTEM

REF - NO	PART NUMBER	PART NAME	QUANTITY	REMARKS
1	6G1-24304-02-00	FUEL PIPE JOINT COMP. 1	1	
2	97395-06025-00	BOLT	1	
3	92990-06600-00	WASHER, PLATE	1	
4	90445-09M75-00	HOSE (L370)	1	
5	90467-08004-00	CLIP	2	
6	655-24560-01-00	FILTER ASSEMBLY	1	
7	6F5-24563-00-00	.ELEMENT, FILTER	1	
8	93210-37M25-00	.O-RING	1	
9	655-24521-01-00	.CUP, FILTER	1	
10	648-24566-01-00	BRACKET, FILTER	1	
11	95380-08600-00	NUT	1	
12	97313-06014-00	BOLT, HEXAGON	1	
13	90445-09072-00	HOSE (L120)	1	
14	90467-08004-00	CLIP	2	
15	6A0-24410-05-00	FUEL PUMP ASSEMBLY	1	
16	648-24411-00-00	.DIAPHRAGM	1	
17	648-24424-00-00	.SEAT, SPRING	1	
18	648-24423-00-00	.SPRING, DIAPHRAGM	1	
19	648-24434-01-00	.GASKET, BODY	1	
20	6A0-24421-01-00	.VALVE, CHECK	2	
21	6A0-14325-00-00	.SCREW, PAN HEAD	2	
22	95380-03600-00	.NUT	2	
23	648-24435-02-00	.GASKET, BODY 2	1	
24	663-24411-00-00	.DIAPHRAGM	1	
25	648-24413-01-00	.BODY 2	1	
26	98580-05530-00	.SCREW, PAN HEAD	3	
27	92990-05100-00	.WASHER, SPRING	3	
28	650-24431-A0-00	GASKET, FUEL PUMP 1	1	
29	97395-06040-00	BOLT	2	
30	92990-06600-00	WASHER, PLATE	2	
31	90445-09072-00	HOSE (L120)	1	
32	90467-08004-00	CLIP	2	
33	688-24378-00-00	PIPE, JOINT 3	2	
34	6H3-24313-00-00	PIPE 3	1	
35	90445-09M22-00	HOSE	2	
36	6H3-24314-00-00	PIPE 4	1	
37	90467-08004-00	CLIP	8	
38	90446-10M01-00	HOSE (L60)	1	

Part Notes

P60TLHP 1991 / FUEL SYSTEM

PART NUMBER		NOTE TEXT
92990-06600-00		OEM: This part number is among the Top 100 Most Popular Marine Maintenance Parts as of March 2014.
650-24431-A0-00		OEM: This part number is among the Top 100 Most Popular Marine Maintenance Parts as of March 2014.
92990-06600-00		OEM: This part number is among the Top 100 Most Popular Marine Maintenance Parts as of March 2014.

©2014 Yamaha Motor Corporation, U.S.A. All rights reserved.

P60TLHP 1991 / FUEL TANK

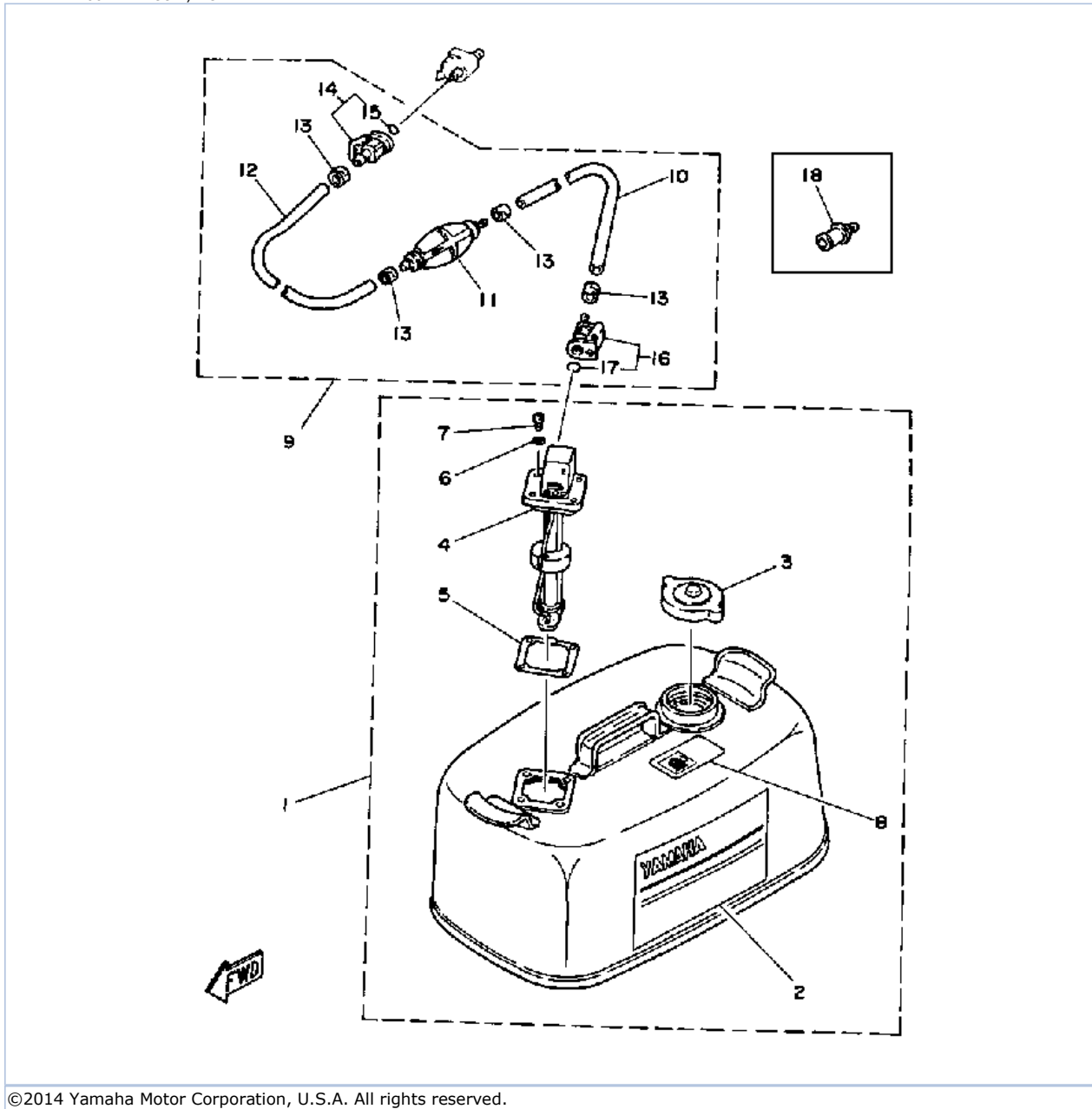

©2014 Yamaha Motor Corporation, U.S.A. All rights reserved.

Part List

P60TLHP 1991 / FUEL TANK

REF - NO	PART NUMBER	PART NAME	QUANTITY	REMARKS
1	6Y1-W2420-42-24	FUEL TANK ASSEMBLY	1	
2	6Y1-24244-20-00	.GRAPHIC, SIDE	1	
3	6Y1-24610-00-00	.CAP ASSEMBLY	1	
4	6Y1-24260-02-00	.FUEL METER ASSEMBLY	1	
5	6Y1-24268-00-00	.GASKET, FUEL METER	1	
6	6Y1-24329-00-00	.SEAL	4	
7	98586-05016-00	.SCREW, PAN HEAD	4	
8	6Y1-24256-50-00	.GRAPHIC, FUEL TANK	1	
9	6Y1-24306-51-00	FUEL PIPE COMP. 1	1	
10	90445-11M06-00	.HOSE (L2050)	1	
11	6Y1-24360-51-00	.PRIMER PUMP ASSY	1	
12	90445-11M05-00	.HOSE (L850)	1	
13	650-24351-51-00	.BAND 1	4	
14	6G1-24305-01-00	.FUEL PIPE JOINT COMP 2	1	
15	93210-08287-00	..O-RING	1	
16	6Y1-24305-02-00	.FUEL PIPE JOINT COMP 2	1	
17	93210-08287-00	..O-RING	1	
18	ABB-FLUSH-JD-00	JET DRIVE FLUSH	1	

P60TLHP 1991 / TOP COWLING

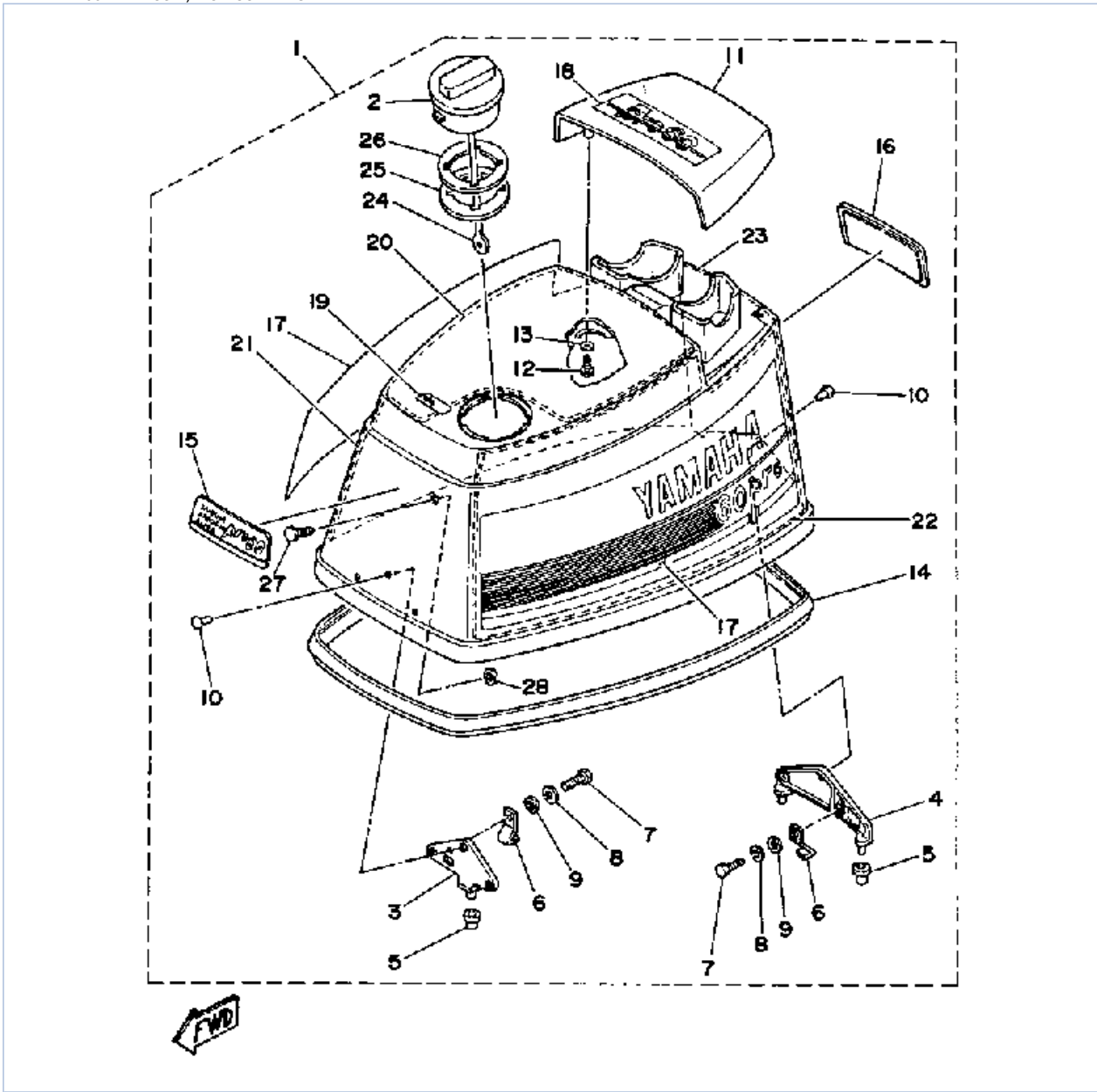

©2014 Yamaha Motor Corporation, U.S.A. All rights reserved.



Part List

P60TLHP 1991 / TOP COWLING

REF - NO	PART NUMBER	PART NAME	QUANTITY	REMARKS
1	6H2-42610-Y0-EK	TOP COWLING ASSEMBLY	1	
2	6H1-2177H-01-00	.DISK CAP 2	1	
3	6H3-42647-00-94	.HOLDER, CLAMP BAND	1	
4	6H3-42649-00-94	.HOLDER, CLAMP BAND	1	
5	663-42662-00-00	.DAMPER	3	
6	6H3-42652-00-00	.HOOK	2	
7	97395-06016-00	.BOLT, HEX	2	
8	92995-06100-00	.WASHER, SPRING	2	
9	92990-06600-00	.WASHER, PLATE	2	
10	90266-06M02-00	.RIVET	6	
11	6H3-42613-00-EK	.MOLDING, AIR DUCT	1	
12	97395-06016-00	.BOLT, HEX	4	
13	92990-06600-00	.WASHER, PLATE	4	
14	6H3-42615-00-00	.SEAL	1	
15	6H2-42686-Y0-00	.EMBLEM, FRONT	1	
16	6H2-42687-Y0-00	.EMBLEM, REAR	1	
17	6H2-W0070-Y0-00	.GRAPHIC SET	1	
18	6H2-42683-Y0-00	.MARK, COWLING 3	1	
19	6H3-13436-40-00	.MARK	1	
20	689-W4266-20-00	.DAMPER, FORM	1	
21	689-W4266-40-00	.DAMPER, FORM	1	
22	689-W4266-40-00	.DAMPER, FORM	1	
23	689-W4266-10-00	.DAMPER, FORM	1	
24	6H1-42694-00-00	.BAND	1	
25	6H3-21732-00-00	.SEAL 1	1	
26	6H3-21735-00-00	.SEAL 2	1	
27	90338-05M12-00	.PLUG	1	
28	90183-05M06-00	.NUT, SPRING	1	

Part Notes

P60TLHP 1991 / TOP COWLING

PART NUMBER	NOTE TEXT
92990-06600-00 	OEM: This part number is among the Top 100 Most Popular Marine Maintenance Parts as of March 2014.
92990-06600-00 	OEM: This part number is among the Top 100 Most Popular Marine Maintenance Parts as of March 2014.

©2014 Yamaha Motor Corporation, U.S.A. All rights reserved.

P60TLHP 1991 / BOTTOM COWLING

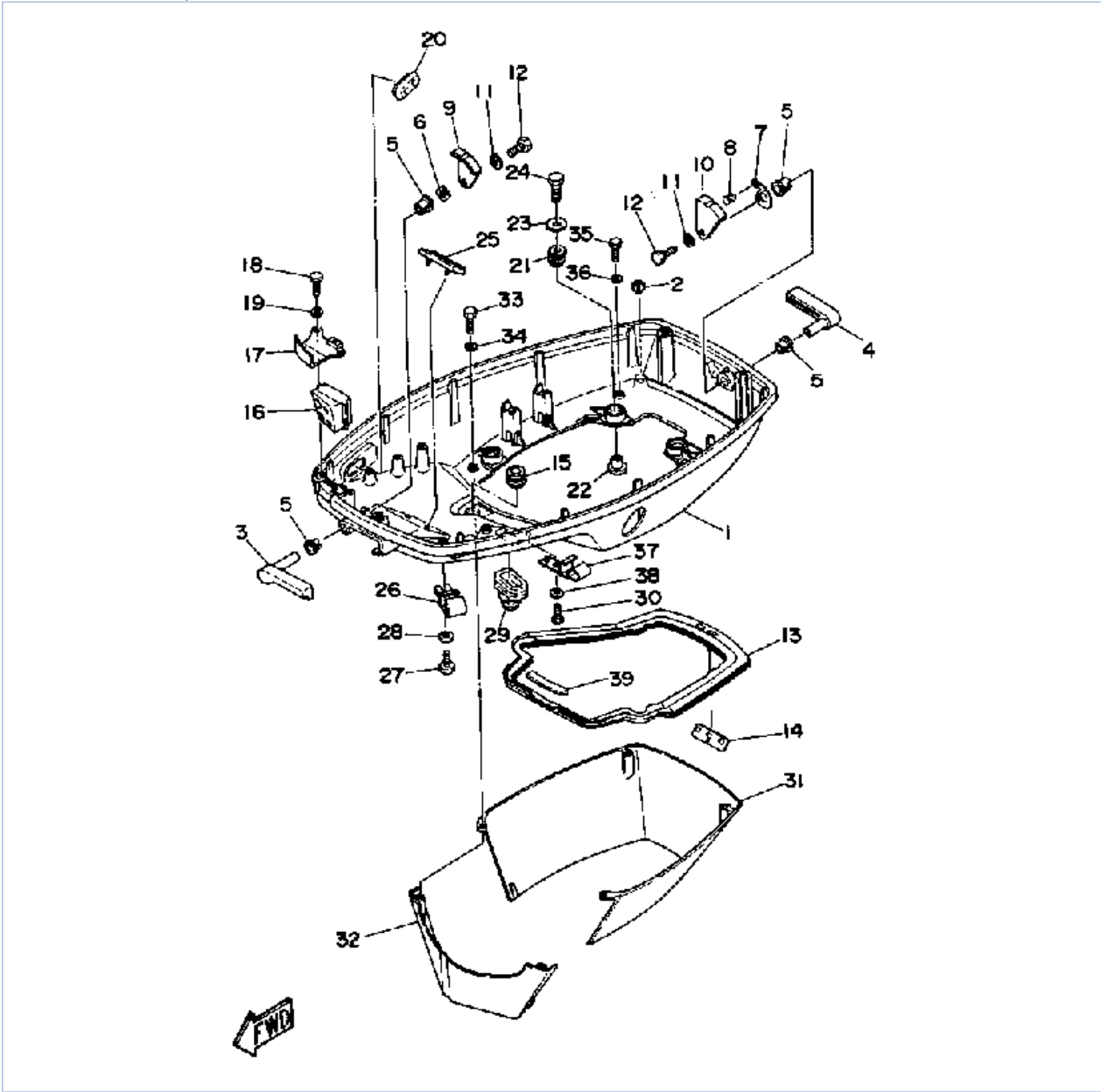

©2014 Yamaha Motor Corporation, U.S.A. All rights reserved.





Part List

P60TLHP 1991 / BOTTOM COWLING

REF - NO	PART NUMBER	PART NAME	QUANTITY	REMARKS
1	6H3-42711-29-EK	BOTTOM COWLING (6H3-42711-22-EK)	1	
2	6H3-44391-01-00	NIPPLE, HOSE	1	
3	6H3-42815-00-EK	LEVER, CLAMP 1	1	
4	6H3-42817-00-EK	LEVER, CLAMP 3	1	
5	90386-13M38-00	BUSH	4	
6	90206-13M10-00	WASHER, WAVE	1	
7	6H3-42813-00-00	SPRING, CLAMP LEVER	1	
8	90269-04M03-00	RIVET	1	
9	6H3-42816-00-00	LEVER, CLAMP	1	
10	6H3-42818-00-00	LEVER, CLAMP	1	
11	90201-06M02-00	WASHER, PLATE	2	
12	97013-06012-00	BOLT	2	
13	6H3-42716-02-00	RUBBER, SEAL 1	1	
14	6K5-42717-00-00	RUBBER, SEAL 2	1	
15	6E5-42724-00-00	GROMMET	1	
16	6H3-42725-20-00	GROMMET	1	
17	6H3-42738-00-5B	PLATE, FITTING	1	
18	97313-06016-00	BOLT, HEXAGON	2	
19	92990-06600-00	WASHER, PLATE	2	
20	6H3-42727-00-00	GROMMET	1	
21	90480-09M12-00	GROMMET	4	
22	90387-06M69-00	COLLAR	4	
23	90201-06416-00	WASHER, PLATE	4	
24	97313-06030-00	BOLT	4	
25	6H3-42768-00-00	DAMPER	1	
26	6E5-24367-01-00	CLAMP, FUEL PIPE 2	1	
27	90157-06M01-00	SCREW, PAN HEAD	1	
28	92990-06600-00	WASHER, PLATE	1	
29	688-42726-10-00	GROMMET	1	
30	90157-06M01-00	SCREW, PAN HEAD	1	
31	6H3-42741-00-EK	APRON 1	1	
32	6H3-42771-00-EK	APRON 2	1	
33	97395-06025-00	BOLT	2	
34	92990-06600-00	WASHER, PLATE	2	
35	97395-06020-00	BOLT, HEXAGON	2	
36	92990-06600-00	WASHER, PLATE	2	
37	6E5-24367-01-00	CLAMP, FUEL PIPE 2	1	
38	92990-06600-00	WASHER, PLATE	1	
39	6H3-42718-00-00	RUBBER, SEAL 3	1	

Part Notes

P60TLHP 1991 / BOTTOM COWLING

PART NUMBER	NOTE TEXT
92990-06600-00 	OEM: This part number is among the Top 100 Most Popular Marine Maintenance Parts as of March 2014.
92990-06600-00 	OEM: This part number is among the Top 100 Most Popular Marine Maintenance Parts as of March 2014.
92990-06600-00 	OEM: This part number is among the Top 100 Most Popular Marine Maintenance Parts as of March 2014.
92990-06600-00 	OEM: This part number is among the Top 100 Most Popular Marine Maintenance Parts as of March 2014.
92990-06600-00 	OEM: This part number is among the Top 100 Most Popular Marine Maintenance Parts as of March 2014.

©2014 Yamaha Motor Corporation, U.S.A. All rights reserved.

P60TLHP 1991 / BRACKET 1

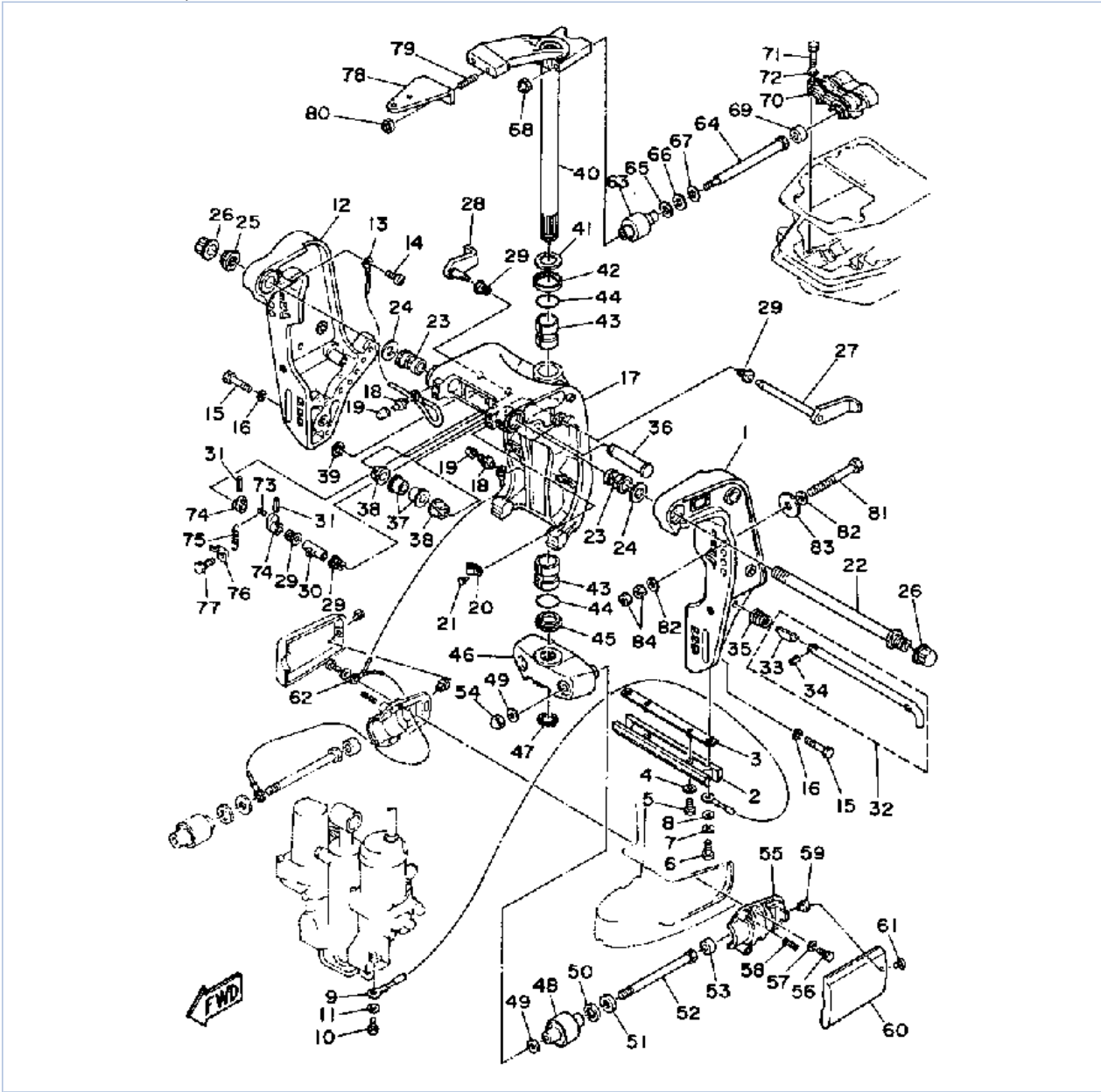

©2014 Yamaha Motor Corporation, U.S.A. All rights reserved.

Part List



P60TLHP 1991 / BRACKET 1

REF - NO	PART NUMBER	PART NAME	QUANTITY	REMARKS
1	6H1-43111-00-EK	BRACKET, CLAMP	1	
2	6H1-45251-02-00	ANODE	1	
3	6H1-44526-00-00	PLATE	1	
4	90201-06M31-00	.WASHER, PLATE	2	
5	97395-06012-00	BOLT	2	
6	97395-06016-00	BOLT, HEX	2	
7	92995-06100-00	WASHER, SPRING	2	
8	92990-06600-00	WASHER, PLATE	2	
9	6H1-82148-00-00	WIRE, LEAD 4	1	
10	97395-06010-00	BOLT	1	
11	92990-06600-00	WASHER, PLATE	1	
12	6H1-43112-00-EK	BRACKET, CLAMP	1	
13	6E5-82148-00-00	WIRE, LEAD 4	1	
14	98580-06012-00	SCREW, PAN HEAD	1	
15	97395-10045-00	BOLT	6	
16	92990-10100-00	WASHER, SPRING	6	
17	6H1-43311-01-EK	BRACKET, SWIVEL 1	1	
18	93700-06M03-00	NIPPLE, GREASE	3	
19	663-45119-00-00	CAP, GREASE NIPPLE	3	
20	90464-11M18-00	CLAMP	1	
21	90338-05M03-00	PLUG	1	
22	688-43131-03-00	BOLT, CLAMP BRACKET	1	
23	90386-22M15-00	BUSH	2	
24	90201-22M67-00	WASHER, PLATE	2	
25	90185-22043-00	NUT, SELF-LOCKING	1	
26	6G5-43145-00-00	CAP, CLAMP BRACKET	2	
27	6H1-43181-01-00	LEVER, TILT STOP	1	
28	6H1-43185-01-00	LEVER, TILT STOP	1	
29	90386-10M16-00	BUSH	4	
30	90387-10M02-00	COLLAR	1	
31	91690-30020-00	PIN, SPRING	2	
32	688-43160-01-00	TILT ROD ASSY	1	LONG
33	688-43165-00-00	.PLATE, TILT LOCK	1	
34	91690-30012-00	.PIN, SPRING	1	
35	90502-16M02-00	SPRING, CONICAL	1	LONG
36	6E5-43126-02-00	PIN, UPPER SHOCK MOUNT	1	
37	90386-18M63-00	BUSH	2	
38	90386-18M35-00	BUSH	2	
39	93410-18M02-00	CIRCLIP	1	
40	6H3-42510-11-EK	STEERING BRACKET	1	
41	90201-30M00-00	WASHER, PLATE	1	
42	90386-30M78-00	BUSH	1	
43	90386-30M77-00	BUSH	2	
44	93210-29M94-00	O-RING	2	
45	90386-30M60-00	BUSH	1	
46	6H3-44551-00-EK	HOUSING, LWR, MOUNTLOWER MOUNT RUBBER	1	
47	93410-28M06-00	CIRCLIP	1	
48	687-44555-00-94	MOUNT DAMPER, LOWER SIDE	2	
49	90201-12M16-00	WASHER, PLATE	4	
50	90202-25M04-00	WASHER, PLATE	2	
51	90201-13M19-00	WASHER, PLATE	2	

52	90109-12M21-00	BOLT	2	
53	663-44575-00-00	DAMPER, LOWER MOUNT RUBBER	2	
54	95380-12800-00	NUT, CROWN	2	
55	6H3-44552-01-94	HOUSING, LOWER MOUNT RUBBER	2	
56	97395-08025-00	BOLT	4	
57	92990-08100-00	WASHER, SPRING	4	
58	90501-14236-00	SPRING, COMPRESSION	4	
59	90179-06066-00	NUT	2	
60	6H3-44553-00-EK	COVER, LWR.MOUNT	2	
61	98580-06016-00	SCREW, PAN HEAD	2	
62	688-82127-02-00	WIRE, LEAD 2	1	LONG
63	688-44514-00-94	MOUNT DAMPER, UPPER SIDE	2	
64	90101-10M49-00	BOLT	2	
65	90201-20M21-00	WASHER, PLATE	2	
66	90202-20M06-00	WASHER, PLATE	2	
67	90201-11M22-00	WASHER, PLATE	2	
68	90185-10051-00	NUT, SELF-LOCKING	2	
69	663-44575-00-00	DAMPER, LOWER MOUNT RUBBER	2	
70	688-44511-00-94	COVER, UPPER MOUNT	1	
71	97090-08035-00	BOLT	3	
72	92990-08100-00	WASHER, SPRING	3	
73	90249-06M19-00	PIN	1	
74	6G5-43148-00-00	COLLAR, DISTANCE	2	
75	90506-14M24-00	SPRING, TENSION	1	
76	6G5-43144-00-00	HOOK, SPRING	1	
77	97395-06010-00	BOLT	1	
78	6H3-48511-51-EK	HOOK STEERING	1	
79	90116-10175-00	BOLT, STUD	2	
80	90185-10051-00	NUT, SELF-LOCKING	2	
81	90101-12M65-00	BOLT	4	
82	92995-12200-00	WASHER	8	
83	90201-12426-00	WASHER, PLATE	4	
84	95380-12600-00	NUT	8	

Part Notes

P60TLHP 1991 / BRACKET 1

PART NUMBER		NOTE TEXT
92990-06600-00		OEM: This part number is among the Top 100 Most Popular Marine Maintenance Parts as of March 2014.
92990-06600-00		OEM: This part number is among the Top 100 Most Popular Marine Maintenance Parts as of March 2014.

©2014 Yamaha Motor Corporation, U.S.A. All rights reserved.

P60TLHP 1991 / BRACKET 2

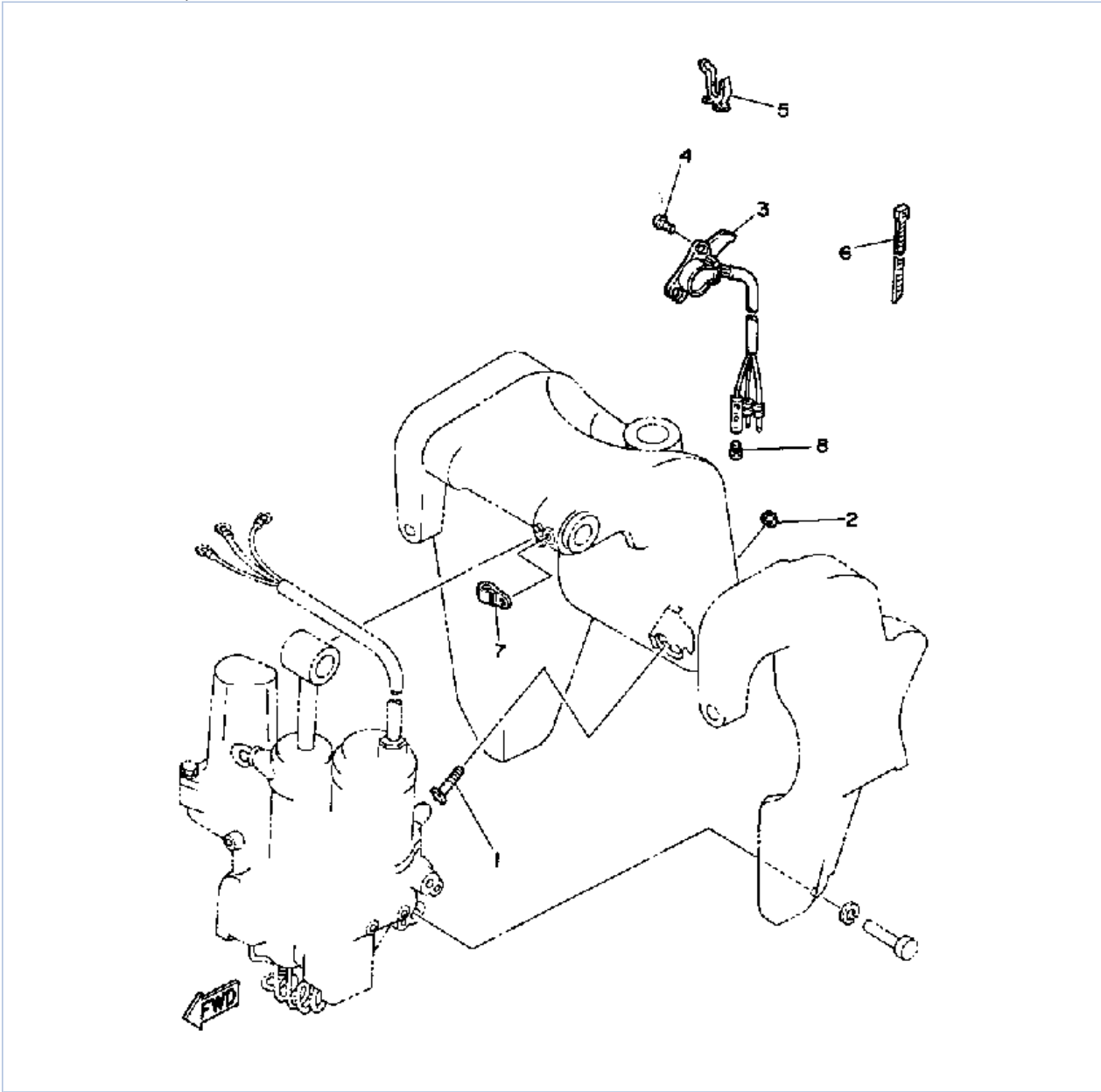

©2014 Yamaha Motor Corporation, U.S.A. All rights reserved.

Part List

P60TLHP 1991 / BRACKET 2

REF - NO	PART NUMBER	PART NAME	QUANTITY	REMARKS
1	6H1-43376-00-00	BOLT, THRUST RECEIVER	2	LONG
2	95780-08300-00	..NUT, FLANGE	2	
3	6H1-83672-10-00	TRIM SENDER	1	
4	98580-06016-00	SCREW, PAN HEAD	2	
5	90464-15M08-00	CLAMP	1	
6	90465-11M10-00	CLAMP	1	
7	90465-08028-00	CLAMP	1	
8	703-82119-00-00	COVER, LEAD WIRE	1	

P60TLHP 1991 / POWER TRIM TILT ASSEMBLY

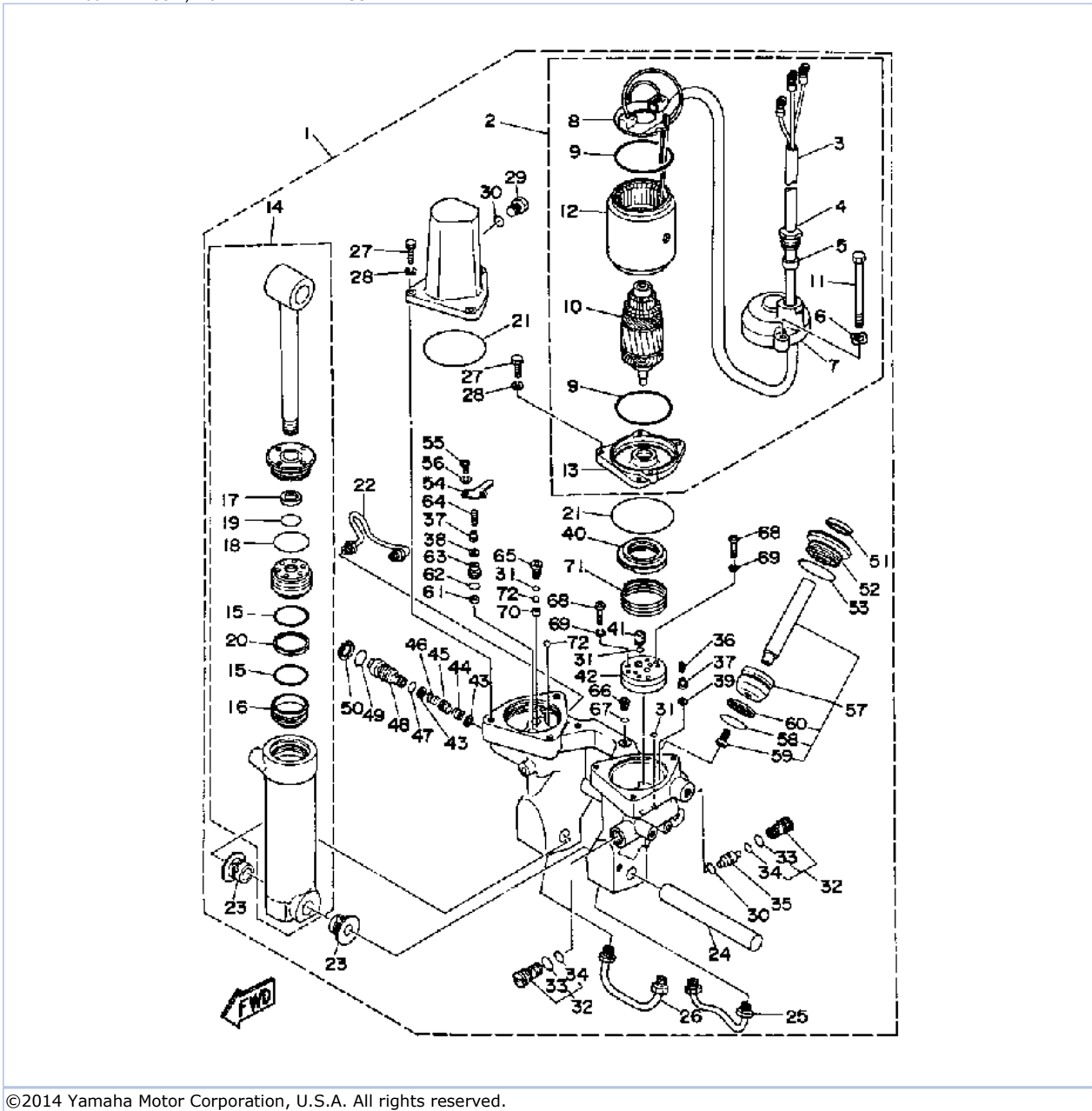

©2014 Yamaha Motor Corporation, U.S.A. All rights reserved.

Part List



P60TLHP 1991 / POWER TRIM TILT ASSEMBLY

REF - NO	PART NUMBER	PART NAME	QUANTITY	REMARKS
1	6H1-43800-12-EK	POWER TRIM & TILT ASSEMBLY	1	
2	6H1-43880-00-00	..MOTOR ASSEMBLY	1	
3	6H1-43807-00-00	..WIRE SUB ASSEMBLY	1	
4	6H1-43886-00-00	..BOLT	1	
5	6H1-43885-00-00	..GROMMET	1	
6	6H1-4382G-00-00	..WASHER, WAVE	1	
7	6H1-43884-00-00	..FRAME, COMMUTATOR	1	
8	6H1-43806-00-00	..BRUSH HOLDER ASSEMBLY	1	
9	93210-71M76-00	..O-RING	2	
10	6H1-43805-00-00	..ARMATURE ASSEMBLY	1	
11	6H1-43887-00-00	..BOLT	2	
12	6H1-43804-00-00	..STATOR ASSEMBLY	1	
13	6H1-43881-00-00	..FRAME, END	1	
14	6H1-43840-11-00	..POWER TILT ASSY	1	
15	6H1-43861-10-00	..O-RING	2	
16	6H1-43814-11-00	..PISTON, FREE	1	
17	6H1-43872-10-00	..RING, BACK UP	1	
18	6H1-43861-00-00	..O-RING	1	
19	93210-18322-00	..O-RING	1	
20	6H1-43871-10-00	..RING, BACK UP	1	
21	6H1-43869-10-00	..O-RING	2	
22	6H1-43835-10-00	..PIPE	1	
23	90386-18M14-00	..BUSH	2	
24	6E5-43818-00-00	..PIN, LOWER SHOCK MOUNT	1	
25	6H1-43833-10-00	..PIPE	1	
26	6H1-43834-00-00	..PIPE	1	
27	97395-06020-00	..BOLT, HEXAGON	6	
28	92995-06100-00	..WASHER, SPRING	6	
29	6H1-43829-00-00	..PLUG, RESERVOIR	1	
30	93210-09350-00	..O-RING	2	
31	93210-06519-00	..O-RING	4	
32	6T4-43802-00-00	..VALVE SUB ASSEMBLY	2	
33	6H1-43866-00-00	..O-RING	1	
34	6H1-43867-00-00	..O-RING	1	
35	6H1-43841-10-00	..PISTON, SHUTTLE	1	
36	6H1-43856-10-00	..SPRING, DOWN RELIEF	1	
37	6H1-43844-10-00	..PIN, VALVE SUPPORT	2	
38	6H1-4384G-11-00	..SEAL, RELIEF VALVE	1	
39	61A-4384F-00-00	..SEAL, MAIN VALVE	1	
40	6H1-43817-01-00	..FILTER 2	1	
41	6H1-43831-00-00	..CONNECTOR, SHAFT	1	
42	6H1-43830-11-00	..GEAR PUMP ASSY	1	
43	6H1-43847-00-00	..SEAT, MANUAL VALVE	2	
44	6H1-43899-00-00	..SPRING, MANUAL RELEASE	1	
45	6H1-4382A-10-00	..ADAPTOR 1	1	
46	6H1-43854-00-00	..SPRING, MANUAL RELEASE	1	
47	93210-10M74-00	..O-RING	1	
48	6H1-43845-01-00	..SCREW, MANUAL RELEASE	1	
49	93210-18M75-00	..O-RING	1	
50	6H1-43875-00-00	..RING, SNAP	1	
51	6H1-43822-10-00	..SEAL, TRIM DUST	2	
52	6H1-43821-11-00	..SCREW, TRIM CYLINDER END	2	

53	6H1-43861-10-00	.O-RING	2	
54	6H1-4384E-20-00	.SPRING, TRIM	2	
55	98580-05010-00	.SCREW, PAN HEAD	2	
56	92990-05200-00	.WASHER, PLAIN	2	
57	6H1-43820-11-00	.TRIM PISTON SUB ASSY	2	
58	6H1-43864-00-00	.O-RING	1	
59	91316-06020-00	.BOLT	1	
60	6H1-43874-00-00	.RING, BACK UP	1	
61	6H1-43816-00-00	.FILTER 1	1	
62	6H1-43896-00-00	.O-RING	1	
63	6H1-43895-11-00	.SEAT, RELIEF VALVE	1	
64	6H1-43855-10-00	.SPRING UP RELIEF	1	
65	6H1-43843-11-00	.SCREW, VALVE LOCK	1	
66	6H1-4388E-11-00	.PLUG, TAPER SCREW	1	
67	6H1-43868-00-00	.O-RING	1	
68	98511-04025-00	.SCREW, PAN HEAD	4	
69	92901-04100-00	.WASHER, SPRING	4	
70	6H1-4387J-00-00	.WASHER, SPECIAL 2	1	
71	6H1-4385H-00-00	.SPRING, SEAL	1	
72	93505-32038-00	.BALL	2	

Part Notes

P60TLHP 1991 / POWER TRIM TILT ASSEMBLY

PART NUMBER		NOTE TEXT
6H1-43861-10-00		OEM: This part number is among the Top 100 Most Popular Marine Maintenance Parts as of March 2014.
6H1-43861-10-00		OEM: This part number is among the Top 100 Most Popular Marine Maintenance Parts as of March 2014.

©2014 Yamaha Motor Corporation, U.S.A. All rights reserved.

P60TLHP 1991 / STEERING

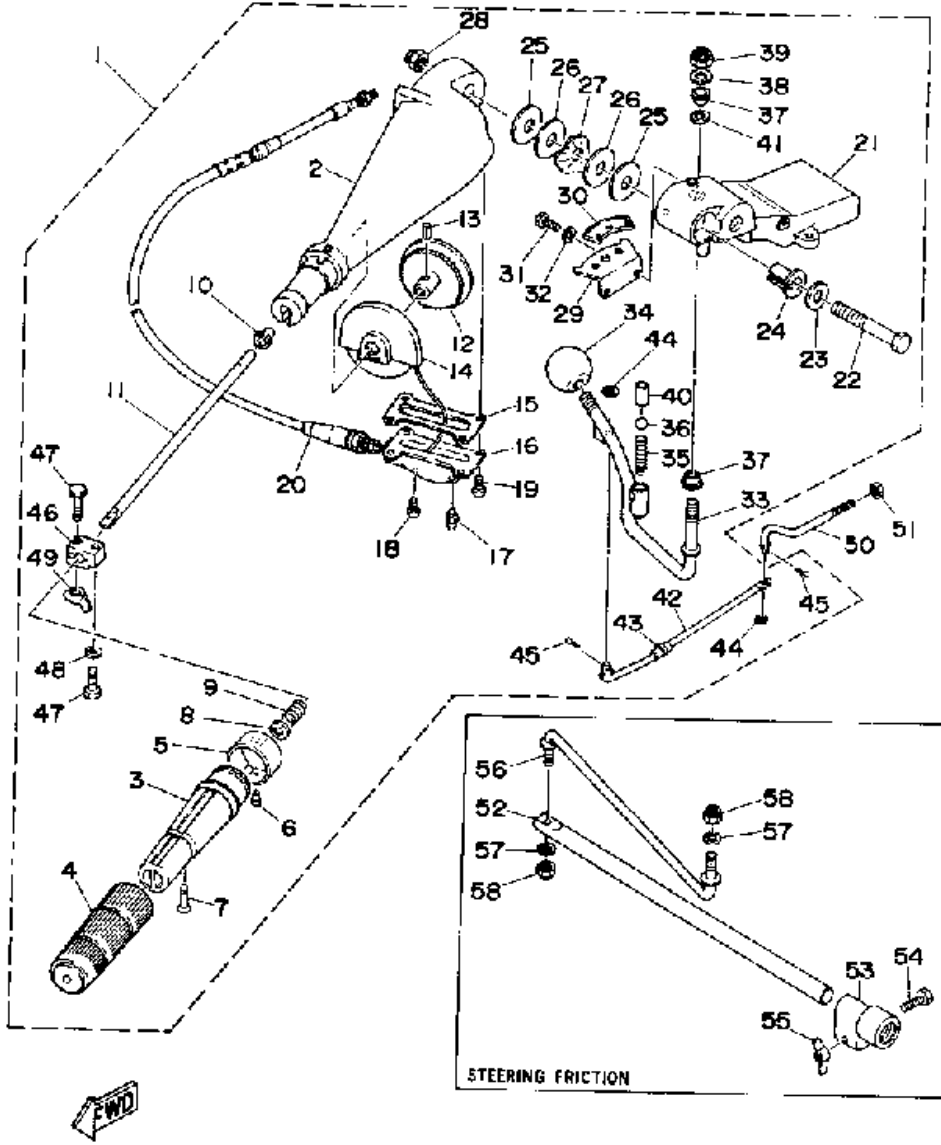

©2014 Yamaha Motor Corporation, U.S.A. All rights reserved.

Part List

P60TLHP 1991 / STEERING

REF - NO	PART NUMBER	PART NAME	QUANTITY	REMARKS
1	6H3-W0084-00-EK	TILLER HANDLE	1	
2	663-42111-01-EK	.HANDLE, STEERING	1	
3	664-42119-00-00	.GRIP, STEERING HANDLE	1	
4	6G1-42177-00-00	.RUBBER, HANDLE	1	
5	6H2-42137-00-00	.INDICATOR, THROTTLE	1	
6	90269-02M09-00	.RIVET	1	
7	90149-05M13-00	.SCREW	1	
8	92990-10600-00	.WASHER, PLATE	1	
9	90501-23215-00	.SPRING, COMPRESSION	1	
10	90386-08032-00	.BUSH	1	
11	663-42115-00-00	.SHAFT, STEERING HANDLE	1	
12	663-42138-00-00	.LEVER, THROTTLE	1	
13	91690-30216-00	.PIN, SPRING	1	
14	663-42135-01-00	.HOUSING, THROTTLE LEVER	1	
15	663-42133-01-00	.GASKET	1	
16	663-42134-02-94	.COVER, THROTTLE LEVER	1	
17	93700-06M03-00	.NIPPLE, GREASE	1	
18	98580-06008-00	.SCREW, PAN HEAD	1	
19	97895-05012-00	.SCREW, PAN HEAD	4	
20	692-26301-03-00	.THROTTLE CABLE ASSY	1	
21	692-42121-01-EK	.BRACKET	1	
22	90101-12M06-00	.BOLT	1	
23	92990-12200-00	.WASHER, PLAIN	1	
24	90386-12089-00	.BUSH	1	
25	90202-12092-00	.WASHER, PLATE	2	
26	90201-12537-00	.WASHER, PLATE	2	
27	90206-12054-00	.WASHER, WAVE	1	
28	90185-12058-00	.NUT, SELF-LOCKING	1	
29	697-44113-00-00	.CAM PLATE, HANDLE	1	
30	6K5-44191-00-00	.INDICATOR, SHIFT	1	
31	97313-06016-00	.BOLT, HEXAGON	2	
32	92995-06100-00	.WASHER, SPRING	2	
33	692-44159-01-00	.HANDLE, GEAR SHIFT	1	
34	663-44173-00-00	.LEVER, SHIFT CONTROL	1	
35	90501-16M17-00	.SPRING, COMPRESSION	1	
36	93515-32M01-00	.BALL	1	
37	90386-10009-00	.BUSH	2	
38	90201-10120-00	.WASHER, PLATE	1	
39	90185-10051-00	.NUT, SELF-LOCKING	1	
40	90387-12M30-00	.COLLAR	1	
41	90201-12M34-00	.WASHER, PLATE	1	
42	6H3-42191-01-00	.ROD 1	1	
43	90386-06088-00	.BUSH	1	
44	92990-06600-00	.WASHER, PLATE	2	
45	91490-25020-00	.PIN COTTER	2	
46	6H3-42192-00-00	ROD 2	1	
47	700-48339-00-00	NUT, CABLE END	1	
48	663-42126-01-00	THROTTLE FRICTION	1	
49	97395-06025-00	BOLT	2	
50	92990-06600-00	WASHER, PLATE	1	
51	90175-06003-00	.NUT, WING	1	
52	663-42518-00-00	.SHAFT, FRICTION	1	
53	663-42528-00-00	.PLATE, FRICTION	1	

54	97395-06035-00	BOLT, HEXAGON	1	
55	90175-06003-00	.NUT, WING	1	
56	692-42515-01-00	.ROD, STEERING LINK	1	
57	92990-08600-00	..WASHER, PLATE	2	
58	95780-08300-00	..NUT, FLANGE	2	

Part Notes

P60TLHP 1991 / STEERING

PART NUMBER		NOTE TEXT
92990-10600-00		OEM: This part number is among the Top 100 Most Popular Marine Maintenance Parts as of March 2014.
92990-06600-00		OEM: This part number is among the Top 100 Most Popular Marine Maintenance Parts as of March 2014.
92990-06600-00		OEM: This part number is among the Top 100 Most Popular Marine Maintenance Parts as of March 2014.

©2014 Yamaha Motor Corporation, U.S.A. All rights reserved.

P60TLHP 1991 / CONTROL ENGINE

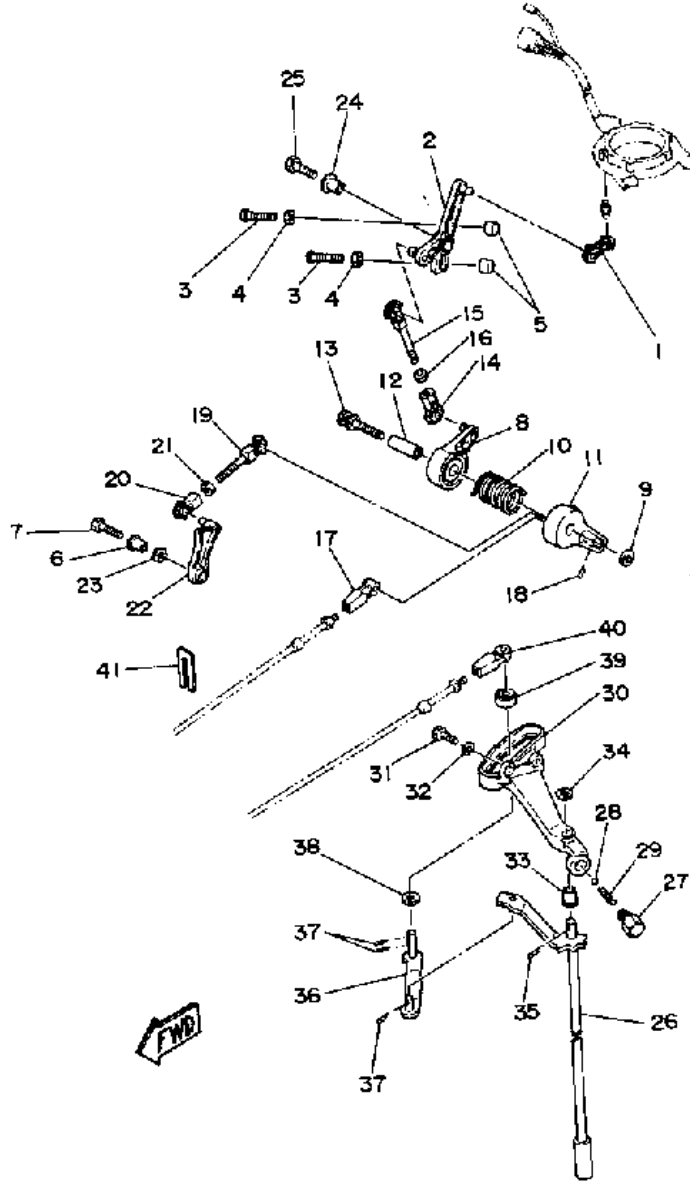

©2014 Yamaha Motor Corporation, U.S.A. All rights reserved.



Part List



P60TLHP 1991 / CONTROL ENGINE

REF - NO	PART NUMBER	PART NAME	QUANTITY	REMARKS
1	6H3-41238-00-00	JOINT, LINK	1	
2	6H3-41631-00-00	LEVER, MAGNETO CONTROL	1	
3	90157-06M13-00	SCREW, PAN HEAD	2	
4	95380-06600-00	NUT, HEXAGON	2	
5	688-44194-00-00	CAP	2	
6	90387-06M60-00	COLLAR	1	
7	97395-06025-00	BOLT	1	
8	6H3-41632-00-00	LEVER, MAGNETO CONTROL	1	
9	90201-06M31-00	.WASHER, PLATE	1	
10	90508-29M19-00	SPRING, TORSION	1	
11	6H3-41633-00-00	LEVER, MAGNETO CONTROL	1	
12	90387-06M59-00	COLLAR	1	
13	90119-06M66-00	BOLT, W/WASHER	1	
14	6H1-41237-00-00	JOINT, LINK	1	
15	679-41636-00-00	ROD, MAGNETO CONTROL	1	
16	95380-05600-00	NUT	1	
17	663-48344-00-00	.CABLE END, REMOTE CONTROL	1	
18	90468-18008-00	CLIP	1	
19	682-41237-50-00	JOINT, LINK	1	
20	6H1-41237-00-00	JOINT, LINK	1	
21	95380-05600-00	NUT	1	
22	6H3-41213-01-00	CAM, ACCEL.	1	
23	90206-10M04-00	WASHER, WAVE	1	
24	90387-06M60-00	COLLAR	1	
25	97395-06025-00	BOLT	1	
26	6H3-44120-11-00	HANDLE GEAR SHIFT ASSEMBLY	1	LONG
27	648-42715-00-00	BUSHING	1	
28	93501-04M02-00	BALL	1	
29	90501-12082-00	SPRING, COMPRESSION	1	
30	6H3-44117-00-94	BRACKET	1	
31	97313-06020-00	BOLT, HEXAGON	2	
32	92990-06600-00	WASHER, PLATE	2	
33	90386-07M58-00	BUSH	1	
34	92990-08200-00	WASHER, PLAIN	1	
35	91490-20015-00	PIN. COTTER	1	
36	6H3-44121-01-00	LEVER, SHIFT ROD	1	
37	90468-18008-00	CLIP	3	
38	90202-07M07-00	WASHER, PLATE	1	
39	688-44122-00-00	BUSHING, SHIFT ROD LEVER	1	
40	663-48344-00-00	.CABLE END, REMOTE CONTROL	1	
41	6H3-48538-00-00	.CLAMP, CABLE 1	1	

Part Notes

P60TLHP 1991 / CONTROL ENGINE

PART NUMBER		NOTE TEXT
6H1-41237-00-00		OEM: This part number is among the Top 100 Most Popular Marine Maintenance Parts as of March 2014.
90468-18008-00		OEM: This part number is among the Top 100 Most Popular Marine Maintenance Parts as of March 2014.
6H1-41237-00-00		OEM: This part number is among the Top 100 Most Popular Marine Maintenance Parts as of March 2014.
92990-06600-00		OEM: This part number is among the Top 100 Most Popular Marine Maintenance Parts as of March 2014.

		
90468-18008-00		OEM: This part number is among the Top 100 Most Popular Marine Maintenance Parts as of March 2014.

©2014 Yamaha Motor Corporation, U.S.A. All rights reserved.

P60TLHP 1991 / UPPER CASING

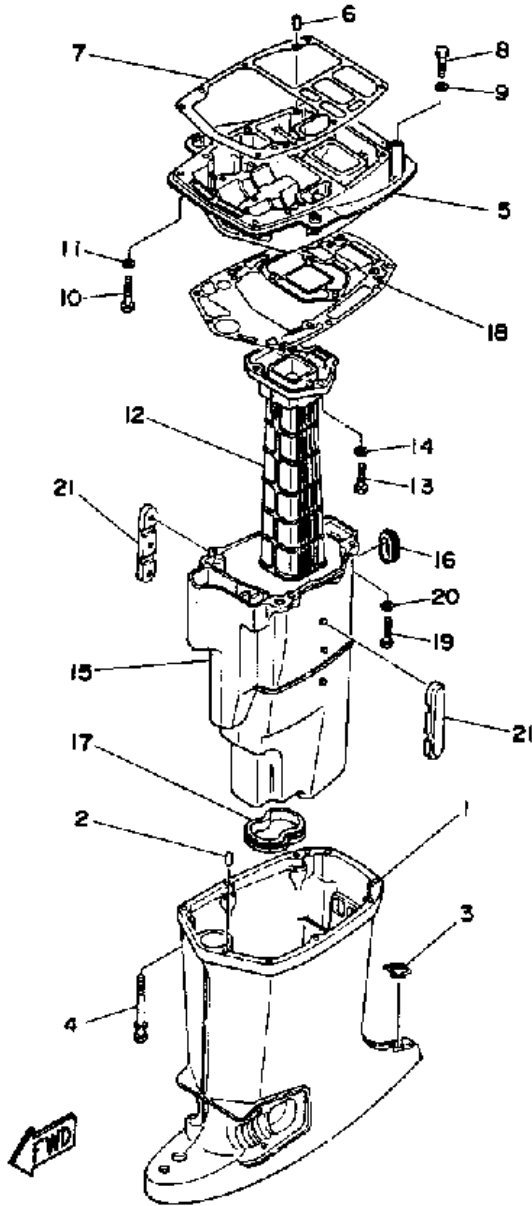

©2014 Yamaha Motor Corporation, U.S.A. All rights reserved.

Part List

P60TLHP 1991 / UPPER CASING

REF - NO	PART NUMBER	PART NAME	QUANTITY	REMARKS
1	6H3-45111-10-EK	CASING, UPPER	1	
2	93606-12019-00	.PIN, DOWEL	2	
3	6H3-45155-00-00	CAP	1	
4	90119-08M81-00	BOLT, WITH WASHER	6	
5	6H3-41137-00-94	GUIDE, EXHAUST	1	
6	93606-12019-00	.PIN, DOWEL	2	
7	6H3-45113-A0-00	GASKET, UPPER CASING	1	
8	97395-08030-00	BOLT	2	
9	92990-08100-00	WASHER, SPRING	2	
10	97090-08035-00	BOLT	2	
11	92990-08100-00	WASHER, SPRING	2	
12	6H2-41131-00-5B	MANIFOLD, EXT. 1	1	
13	97395-08030-00	BOLT	3	
14	92990-08100-00	WASHER, SPRING	3	
15	6H3-14711-10-5B	MUFFLER 1	1	
16	6H3-45127-00-00	SEAL	1	
17	6H3-45123-00-00	GASKET, MUFFLER	1	
18	6H3-45114-A1-00	.GASKET, UPPER CASING	1	
19	97395-08030-00	BOLT	4	
20	92990-08100-00	WASHER, SPRING	4	
21	6H3-14737-10-00	DAMPER, MUFFLER	2	LONG

P60TLHP 1991 / LOWER DRIVE 1

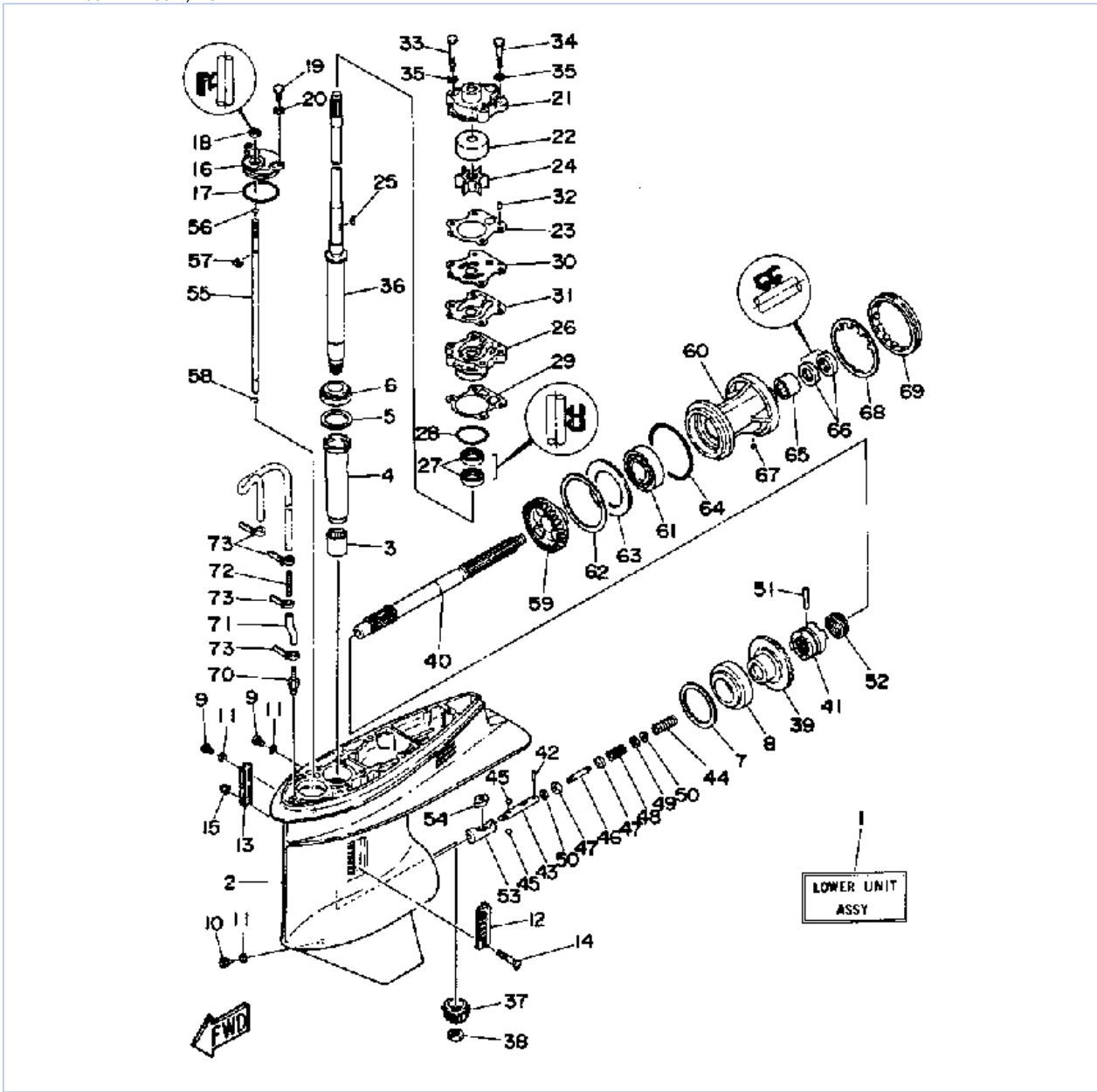

©2014 Yamaha Motor Corporation, U.S.A. All rights reserved.

Part List





P60TLHP 1991 / LOWER DRIVE 1

REF - NO	PART NUMBER	PART NAME	QUANTITY	REMARKS
1	6H3-45300-13-EK	LOWER UNIT ASSEMBLY	1	
2	6H1-45301-02-EK	LOWER CASING	1	
3	93315-325V1-00	BEARING	1	
4	688-45536-01-00	SLEEVE, DRIVE SHAFT	1	
5	688-45587-01-12	SHIM (T:0.12MM)	1	UR
5	688-45587-01-30	SHIM (T:0.30MM)	1	UR
5	688-45587-01-50	SHIM (T:0.50MM)	1	UR
5	688-45587-01-10	SHIM (T:0.10MM)	1	UR
5	688-45587-01-15	SHIM (T:0.15MM)	1	UR
5	688-45587-01-18	SHIM (T:0.18MM)	1	UR
5	688-45587-01-40	SHIM (T:0.40MM)	1	UR
6	93332-000U3-00	BEARING	1	
7	688-45567-01-12	SHIM (T:0.12MM)	1	UR
7	688-45567-01-30	SHIM (T:0.30MM)	1	UR
7	688-45567-01-50	SHIM (T:0.50MM)	1	UR
7	688-45567-01-10	SHIM (T:0.10MM)	1	UR
7	688-45567-01-15	SHIM (T:0.15MM)	1	UR
7	688-45567-01-18	SHIM (T:0.18MM)	1	UR
7	688-45567-01-40	SHIM (T:0.40MM)	1	UR
8	93332-000U5-00	BEARING	1	
9	90340-08M04-00	PLUG, STRAIGHT SCREW	2	
10	688-45341-00-00	PLUG, DRAIN	1	
11	90430-08020-00	.GASKET	3	
12	688-45214-02-00	COVER, WATER INLET 1	1	
13	688-45215-02-00	COVER, WATER INLET 2	1	
14	98680-05545-00	SCREW, OVAL HEAD	1	
15	90185-05002-00	NUT, NYLON	1	
16	688-45321-00-00	PLATE	1	
17	93210-49046-00	.O-RING	1	
18	93106-09014-00	.OIL SEAL	1	
19	97395-06016-00	BOLT, HEX	2	
20	92990-06600-00	WASHER, PLATE	2	
21	6H3-44311-00-00	HOUSING, WATER PUMP	1	
22	663-44322-00-00	.INSERT, CARTRIDGE	1	
23	6H3-44315-00-00	GASKET, WATER PUMP	1	
24	6H3-44352-00-00	.IMPELLER	1	
25	90280-03M03-00	.KEY, WOODRUFF	1	
26	6H3-44341-00-94	HOUSING, WATER PUMP	1	
27	93101-23070-00	.OIL SEAL	2	
28	93210-46044-00	O-RING	1	
29	688-44316-A0-00	.GASKET, WATER PUMP	1	
30	6H3-44323-00-00	.OUTER PLATE, CARTRIDGE	1	
31	6H3-44324-A0-00	.GASKET, CARTRIDGE	1	
32	93604-10M03-00	PIN, DOWEL	2	
33	97395-08055-00	BOLT	2	
34	97395-08045-00	BOLT	2	
35	90209-08M02-00	WASHER	4	
36	6H3-45501-10-00	DRIVE SHAFT COMP.	1	LONG
37	6K5-45551-00-00	PINION (12T)	1	
38	90170-16M01-00	NUT	1	
39	6K5-45560-00-00	GEAR 1 (28T)	1	
40	6H1-45611-01-00	SHAFT, PROPELLER	1	
41	6H1-45631-01-00	CLUTCH, DOG	1	

42	93603-12M11-00	PIN, DOWEL	1	
43	6H1-45634-02-00	SLIDE, SHIFT	1	
44	90501-16M65-00	SPRING, COMPRESSION	1	
45	93503-16010-00	BALL 3-16	2	
46	6H1-45668-00-00	SHAFT, FREE 1	1	
47	6H1-45635-00-00	PLUNGER, SHIFT	2	
48	90501-12M48-00	SPRING, COMPRESSION	1	
49	90201-03313-00	WASHER, PLATE	1	
50	90183-02M03-00	NUT, SPRING	2	
51	90250-07M02-00	PIN, STRAIGHT	1	
52	688-45633-00-00	RING, CROSS PIN	1	
53	6H1-45641-01-00	SHIFTER	1	
54	6H1-44151-00-00	CAM, SHIFT	1	
55	6H1-44144-00-00	ROD, SHIFT	1	
56	93210-07540-00	.O-RING	1	
57	99001-08600-00	CIRCLIP	1	
58	93450-07M00-00	CIRCLIP	1	
59	6H3-45571-00-00	GEAR (28T)	1	
60	688-45331-00-94	HOUSING, BEARING	1	
61	93306-207U0-00	.BEARING	1	
62	688-45577-01-12	SHIM (T:0.12MM)	1	UR
62	688-45577-01-30	SHIM (T:0.30MM)	1	UR
62	688-45577-01-50	SHIM (T:0.50MM)	1	UR
62	688-45577-01-10	SHIM (T:0.10MM)	1	UR
62	688-45577-01-15	SHIM (T:0.15MM)	1	UR
62	688-45577-01-18	SHIM (T:0.18MM)	1	UR
62	688-45577-01-40	SHIM (T:0.40MM)	1	UR
63	688-45576-00-00	WASHER, THRUST	1	
64	93210-85M97-00	O-RING	1	
65	93317-325U0-00	BEARING	1	
66	93101-25M03-00	.OIL SEAL	2	
67	90282-04010-00	KEY, STRAIGHT	1	
68	688-45383-02-00	WASHER, CLAW	1	
69	688-45384-00-00	NUT	1	
70	6E5-45378-00-00	NIPPLE, HOSE	1	
71	90445-07ME9-00	HOSE (L120)	1	LONG
72	6E5-83558-10-00	END, NIPPLE	1	
73	90465-11M10-00	CLAMP	4	

Part Notes

P60TLHP 1991 / LOWER DRIVE 1

PART NUMBER		NOTE TEXT
90430-08020-00		OEM: This part number is among the Top 100 Most Popular Marine Maintenance Parts as of March 2014.
93106-09014-00		OEM: This part number is among the Top 100 Most Popular Marine Maintenance Parts as of March 2014.
92990-06600-00		OEM: This part number is among the Top 100 Most Popular Marine Maintenance Parts as of March 2014.
6H3-44352-00-00		OEM: This part number is among the Top 100 Most Popular Marine Maintenance Parts as of March 2014.
93101-25M03-00		OEM: This part number is among the Top 100 Most Popular Marine Maintenance Parts as of March 2014.

©2014 Yamaha Motor Corporation, U.S.A. All rights reserved.

P60TLHP 1991 / LOWER DRIVE 2

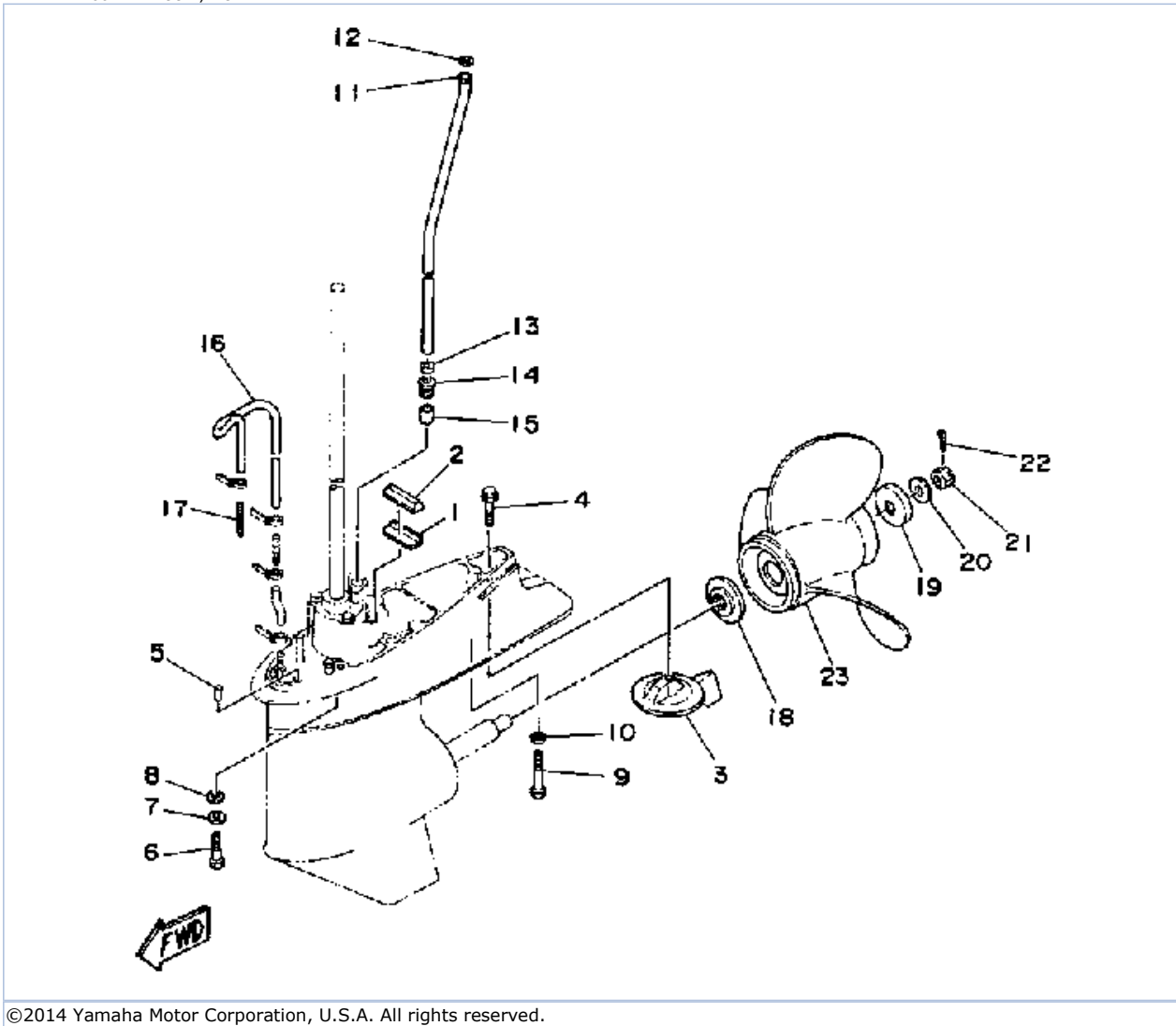

©2014 Yamaha Motor Corporation, U.S.A. All rights reserved.





Part List

P60TLHP 1991 / LOWER DRIVE 2

REF - NO	PART NUMBER	PART NAME	QUANTITY	REMARKS
1	663-45376-00-94	GUIDE, SEAL DAMPER	1	
2	688-45375-00-00	DAMPER, SEAL	1	
3	688-45371-02-00	TAB-TRIM	1	
4	90105-10M00-00	BOLT, FLANGE	1	
5	93606-12019-00	.PIN, DOWEL	2	
6	97395-10040-00	BOLT	4	
7	92990-10100-00	WASHER, SPRING	4	
8	92990-10600-00	WASHER, PLATE	4	
9	97395-08060-00	BOLT, HEXAGON	1	
10	92990-08100-00	WASHER, SPRING	1	
11	6H3-44361-10-00	TUBE, WATER	1	LONG
12	90202-12060-00	WASHER, PLATE	1	
13	90430-12072-00	GASKET	1	
14	663-44367-00-00	DAMPER, WATER SEAL 3	1	
15	663-44366-00-00	.DAMPER, WATER SEAL 2	1	
16	90445-07MF1-00	HOSE (L570)	1	
17	6E5-83558-00-00	END, NIPPLE	1	
18	688-45987-01-00	SPACER 1	1	
19	688-45997-01-00	SPACER 2	1	
20	90201-17M00-00	WASHER, PLATE	1	
21	90171-16011-00	NUT, CASTLE	1	
22	91490-40030-00	PIN. COTTER	1	
23	688-45974-02-98	PROPELLER (3X13"X23"-K)	1	UR
23	688-45978-60-98	PROPELLER (3X13-1/2"X16"-K)	1	UR
23	688-45930-01-98	PROPELLER (3X13"X17"-K)	1	UR
23	688-45932-60-98	PROPELLER (3X13-1/2"X14"-K)	1	UR
23	6E5-45952-00-EL	PROPELLER (3X13"X23"-K)	1	UR
23	6E5-45954-00-EL	PROPELLER (3X14"X11"-K)	1	UR
23	688-45976-01-98	PROPELLER (3X13"X25"-K)	1	UR
23	6E5-45956-00-EL	PROPELLER (3X13"X25"-K)	1	UR
23	6E5-45941-00-EL	PROPELLER (3X13"X19"-K)	1	UR
23	688-45972-02-98	PROPELLER (3X13"X21"-K)	1	UR
23	688-45970-03-98	PROPELLER (3 X 13-1/2" X 19" -K) ()	1	UR
23	6E5-45949-00-EL	PROPELLER (3X13-5/8"X13"-K)	1	UR
23	6E5-45943-00-EL	PROPELLER (3X12-5/8"X21"-K)	1	UR
23	6E5-45945-01-EL	PROPELLER (3X13-1/4"X17"-K)	1	UR
23	6E5-45947-00-EL	PROPELLER (3X13-1/2"X15"-K)	1	UR

Part Notes

P60TLHP 1991 / LOWER DRIVE 2

PART NUMBER	NOTE TEXT
90105-10M00-00 	OEM: This part number is among the Top 100 Most Popular Marine Maintenance Parts as of March 2014.
92990-10600-00 	OEM: This part number is among the Top 100 Most Popular Marine Maintenance Parts as of March 2014.
688-45997-01-00 	OEM: This part number is among the Top 100 Most Popular Marine Maintenance Parts as of March 2014.
91490-40030-00 	OEM: This part number is among the Top 100 Most Popular Marine Maintenance Parts as of March 2014.

©2014 Yamaha Motor Corporation, U.S.A. All rights reserved.

P60TLHP 1991 / CDI MAGNETO

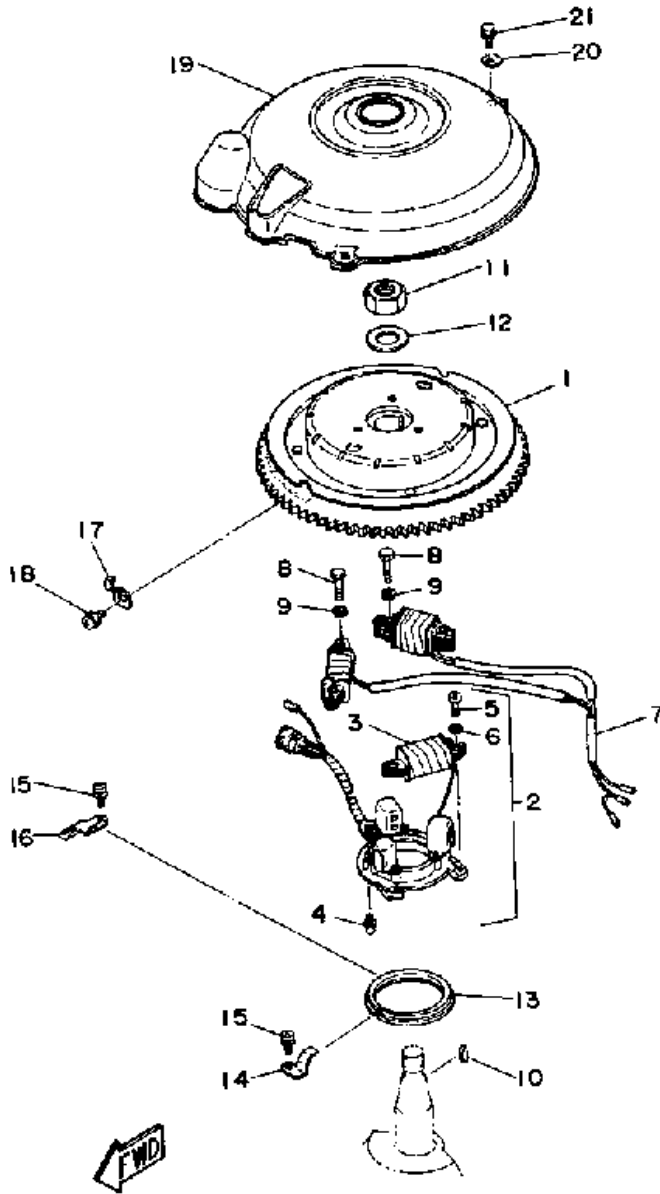

©2014 Yamaha Motor Corporation, U.S.A. All rights reserved.

Part List

P60TLHP 1991 / CDI MAGNETO

REF - NO	PART NUMBER	PART NAME	QUANTITY	REMARKS
1	6K5-85550-A0-00	ROTOR ASSY	1	
2	6H3-85510-A0-00	STATOR ASSEMBLY	1	
3	6H3-85520-00-00	.COIL, CHARGE	1	
4	663-85518-00-00	.JOINT, BALL	1	
5	98580-05016-00	.SCREW, PAN HEAD	2	
6	92990-05100-00	.WASHER, SPRING	2	
7	6H3-85533-00-00	COIL, LIGHTING	1	
8	97313-06030-00	BOLT	4	
9	92990-06600-00	WASHER, PLATE	4	
10	90280-05049-00	KEY, WOODRUFF	1	
11	90170-20137-00	NUT	1	
12	90201-21M18-00	WASHER, PLATE	1	
13	6H3-41611-00-00	RETAINER, MAGNETO BASE	1	
14	6H3-41612-00-00	RETAINER, MAGNETO BASE	2	
15	97985-06212-00	SCREW, WITH WASHER	3	
16	6H3-41612-20-00	RETAINER, MAGNETO BASE	1	
17	6E5-81332-00-00	PLATE, TIMING	1	
18	97985-06210-00	SCREW, WITH WASHER	1	
19	6H3-81337-01-00	COVER, FLYWHEEL	1	
20	90209-06M04-00	WASHER	3	
21	95895-06016-00	BOLT, FLANGE	3	

Part Notes

P60TLHP 1991 / CDI MAGNETO

PART NUMBER	NOTE TEXT
92990-06600-00 	OEM: This part number is among the Top 100 Most Popular Marine Maintenance Parts as of March 2014.

©2014 Yamaha Motor Corporation, U.S.A. All rights reserved.

P60TLHP 1991 / ELECTRIC MOTOR

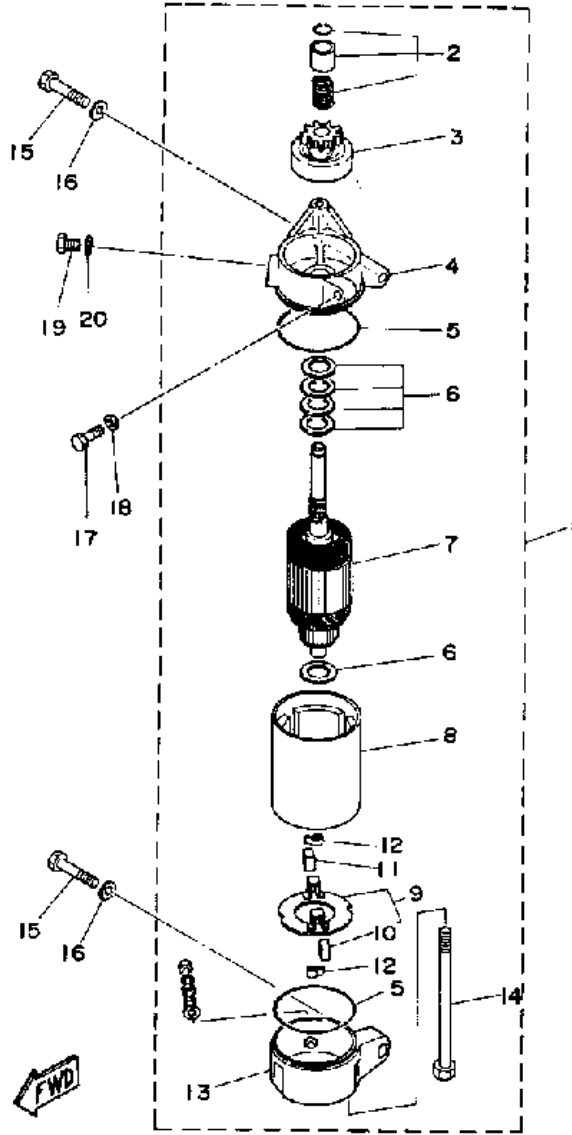

©2014 Yamaha Motor Corporation, U.S.A. All rights reserved.

Part List

P60TLHP 1991 / ELECTRIC MOTOR

REF - NO	PART NUMBER	PART NAME	QUANTITY	REMARKS
1	6H3-81800-11-00	STARTING MOTOR ASSY	1	
2	689-81857-11-00	.PINION STOPPER SET	1	
3	6H3-81807-10-00	.GEAR ASSY, STARTING MOTOR	1	
4	6H3-81830-10-00	.FRONT BRACKET ASSY	1	
5	689-81847-11-00	.O-RING	2	
6	689-81809-11-00	.WASHER KIT	1	
7	689-81850-12-00	.ARMATURE ASSY	1	
8	6H3-81810-10-00	.STATOR ASSY	1	
9	689-81840-11-00	.BRUSH HOLDER ASSY	1	
10	689-81812-11-00	..BRUSH 2	1	
11	689-81811-11-00	.BRUSH 1	1	
12	689-81813-10-00	.SPRING, BRUSH	2	
13	6H3-81820-11-00	.REAR BRACKET ASSY	1	
14	689-81826-10-00	.BOLT	2	
15	97313-08035-00	BOLT	2	
16	92990-08600-00	..WASHER, PLATE	2	
17	97313-06025-00	BOLT	1	
18	92990-06600-00	WASHER, PLATE	1	
19	97313-08016-00	BOLT, HEXAGON	1	
20	92990-08600-00	..WASHER, PLATE	1	

Part Notes

P60TLHP 1991 / ELECTRIC MOTOR

PART NUMBER	NOTE TEXT
92990-06600-00 	OEM: This part number is among the Top 100 Most Popular Marine Maintenance Parts as of March 2014.

©2014 Yamaha Motor Corporation, U.S.A. All rights reserved.

P60TLHP 1991 / ELECTRIC PARTS 1

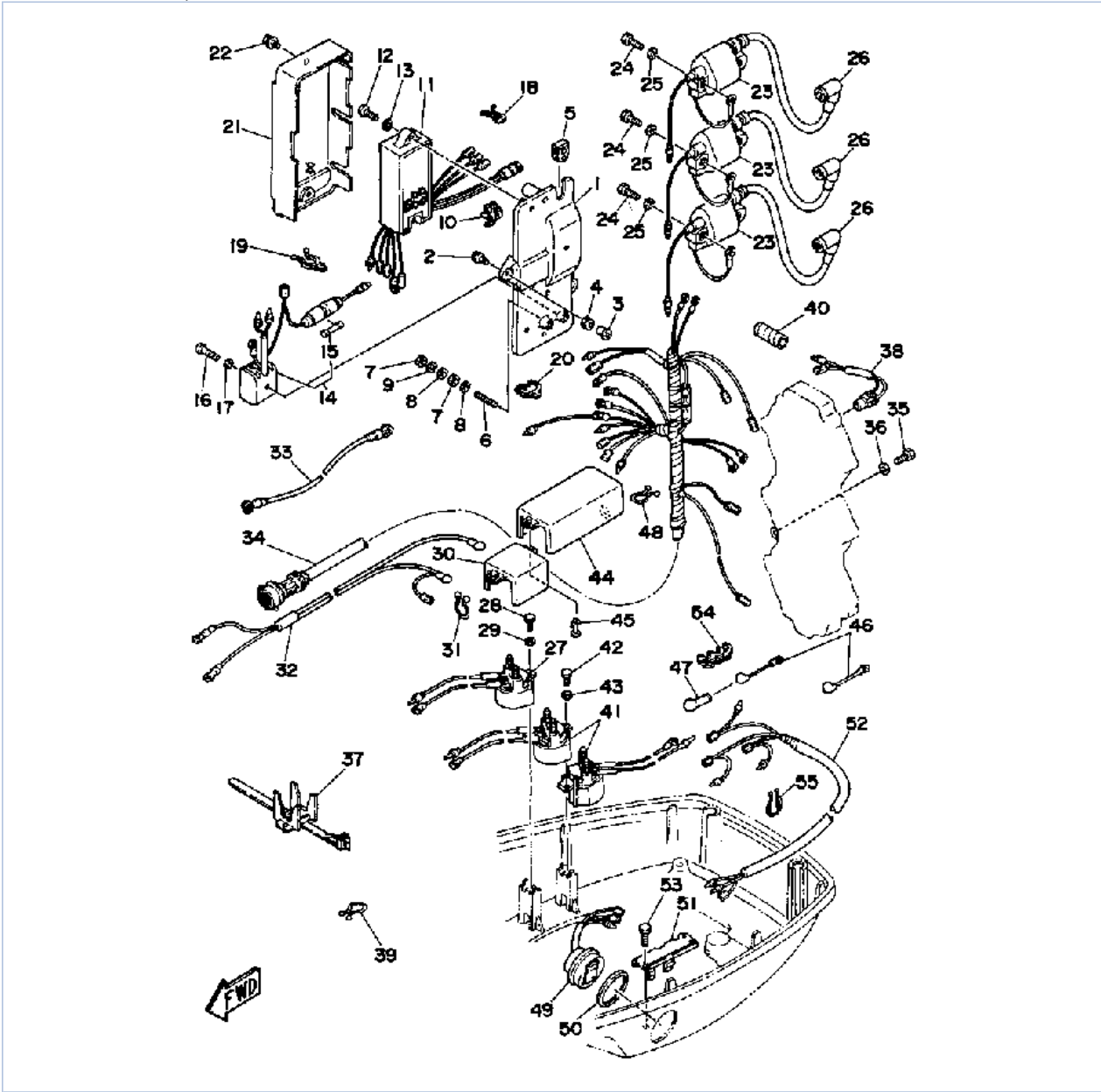

©2014 Yamaha Motor Corporation, U.S.A. All rights reserved.

Part List





P60TLHP 1991 / ELECTRIC PARTS 1

REF - NO	PART NUMBER	PART NAME	QUANTITY	REMARKS
1	6H3-85542-00-94	BRACKET	1	
2	90105-06M14-00	BOLT FLANGE	3	
3	90387-06M43-00	COLLAR	3	
4	90480-13M24-00	GROMMET	3	
5	6H3-81922-00-00	GROMMET	1	
6	90116-06M07-00	BOLT, STUD	1	
7	95380-06700-00	NUT	2	
8	92990-06200-00	WASHER, PLAIN	2	
9	92995-06100-00	WASHER, SPRING	1	
10	90464-04M12-00	CLAMP	1	
11	6H3-85540-11-00	C.D.I. UNIT ASSY	1	
12	98580-06025-00	SCREW, PAN HEAD	2	
13	92990-06600-00	WASHER, PLATE	2	
14	6G1-81970-61-00	RECTIFIER ASSY	1	
15	6G1-82151-00-00	.FUSE (10A)	1	
16	98503-05025-00	SCREW, PAN HEAD	1	
17	92990-05600-00	WASHER, PLATE	1	
18	90465-18147-00	CLAMP	1	
19	90464-12M17-00	CLAMP	1	
20	90464-07M10-00	CLAMP	1	
21	6H3-81916-00-00	COVER, TERMINAL	1	
22	97985-06212-00	SCREW, WITH WASHER	2	
23	6H3-85570-10-00	IGNITION COIL ASSY	3	
24	97313-06025-00	BOLT	6	
25	92990-06600-00	WASHER, PLATE	6	
26	663-82370-01-00	PLUG CAP ASSY	3	
27	688-81950-10-00	RELAY ASSY	1	
28	97313-06016-00	BOLT, HEXAGON	1	
29	92990-06600-00	WASHER, PLATE	1	
30	6H3-82164-00-00	CASE 2	1	
31	90464-16039-00	CLAMP	1	
32	6H3-82105-00-00	BATTERY CABLE	1	
33	6H3-82117-00-00	WIRE, LEAD	1	
34	6H3-82590-11-00	WIRE HARNESS ASSEMBLY	1	
35	97013-06012-00	BOLT	1	
36	92990-06600-00	WASHER, PLATE	1	
37	688-82594-00-00	CLAMP	1	
38	688-82560-10-00	THERMO SWITCH ASSY	1	
39	90465-18147-00	CLAMP	1	
40	90446-10M02-00	HOSE	1	
41	688-81950-10-00	RELAY ASSY	2	
42	97313-06020-00	BOLT, HEXAGON	1	
43	92990-06600-00	WASHER, PLATE	1	
44	6H3-82154-00-00	CASE	1	
45	90338-06M10-00	PLUG (6H2)	1	
46	688-81949-00-00	WIRE, LEAD	2	
47	6E5-82119-00-00	COVER, LEAD WIRE	2	
48	90464-16039-00	CLAMP	1	
49	6H1-82563-00-00	TRIM & TILT SWITCH ASSEMBLY	1	
50	6E5-82587-00-00	GASKET	1	
51	6E5-83614-01-00	BRACKET	1	
52	6H3-82553-00-00	EXTENSION, WIRE	1	
53	97313-06016-00	BOLT, HEXAGON	1	

54	90464-07M05-00	CLAMP	1
55	90464-18M14-00	CLAMP	1

Part Notes

P60TLHP 1991 / ELECTRIC PARTS 1

PART NUMBER		NOTE TEXT
92990-06600-00		OEM: This part number is among the Top 100 Most Popular Marine Maintenance Parts as of March 2014.
92990-06600-00		OEM: This part number is among the Top 100 Most Popular Marine Maintenance Parts as of March 2014.
92990-06600-00		OEM: This part number is among the Top 100 Most Popular Marine Maintenance Parts as of March 2014.
92990-06600-00		OEM: This part number is among the Top 100 Most Popular Marine Maintenance Parts as of March 2014.
92990-06600-00		OEM: This part number is among the Top 100 Most Popular Marine Maintenance Parts as of March 2014.

©2014 Yamaha Motor Corporation, U.S.A. All rights reserved.

P60TLHP 1991 / ELECTRIC PARTS 2

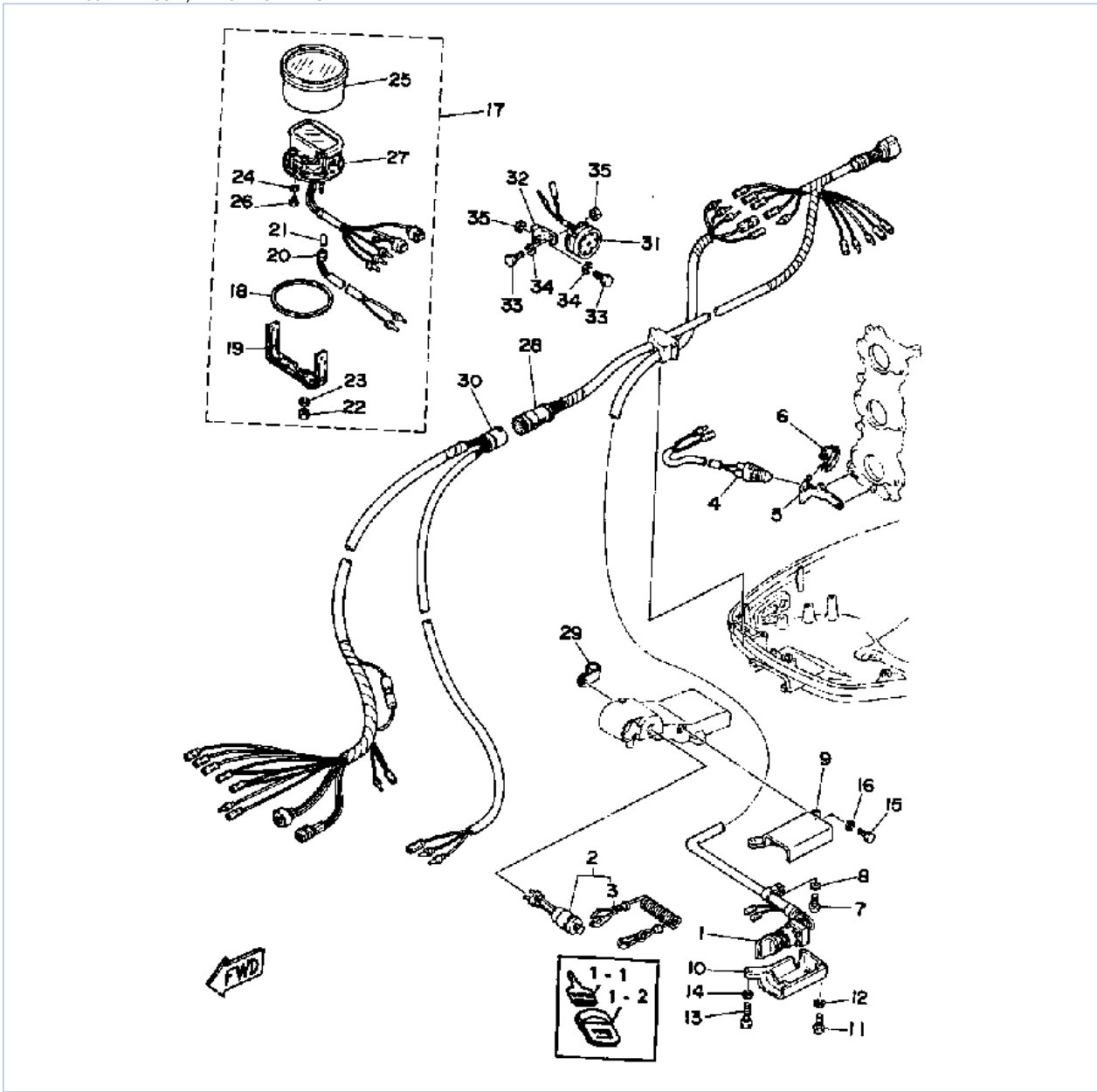

©2014 Yamaha Motor Corporation, U.S.A. All rights reserved.

Part List

P60TLHP 1991 / ELECTRIC PARTS 2

REF - NO	PART NUMBER	PART NAME	QUANTITY	REMARKS
1	90890-55957-00	KEY #111	1	UR
1	90890-55958-00	KEY #112	1	UR
1	6H5-82510-00-00	MAIN SWITCH ASSY	1	
1	90890-55839-00	KEY #470	1	UR
1	90890-55838-00	KEY #469	1	UR
1	90890-55837-00	KEY #468	1	UR
1	90890-55836-00	KEY #467	1	UR
1	90890-55835-00	KEY #466	1	UR
1	90890-55959-00	KEY #113	1	UR
1	90890-55960-00	KEY #121	1	UR
1	90890-55961-00	KEY #122	1	UR
1	90890-55962-00	KEY #123	1	UR
1	90890-55820-00	KEY #451	1	UR
1	90890-55821-00	KEY #452	1	UR
1	90890-55822-00	KEY #453	1	UR
1	90890-55823-00	KEY #454	1	UR
1	90890-55824-00	KEY #455	1	UR
1	90890-55825-00	KEY #456	1	UR
1	90890-55826-00	KEY #457	1	UR
1	90890-55827-00	KEY #458	1	UR
1	90890-55828-00	KEY #459	1	UR
1	90890-55829-00	KEY #460	1	UR
1	90890-55830-00	KEY #461	1	UR
1	90890-55831-00	KEY #462	1	UR
1	90890-55832-00	KEY #463	1	UR
1	90890-55833-00	KEY #464	1	UR
1	90890-55834-00	KEY #465	1	UR
2	688-82575-01-00	.ENGINE STOP SWITCH ASSY	1	
2	676-82577-00-00	..CAP, KEY	1	
3	682-82556-00-00	.LANYARD, STOP SWITCH	1	
4	6H3-82540-00-00	NEUTRAL SWITCH ASSY	1	
5	6H3-82554-00-00	STAY, NEUTRAL SWITCH	1	
6	663-82555-01-00	DAMPER, MAIN SWITCH 1	1	
7	98580-06012-00	SCREW, PAN HEAD	1	
8	92995-06100-00	WASHER, SPRING	1	
9	697-8252E-00-EK	COVER, MAIN SWITCH	1	
10	697-8252F-00-EK	COVER, MAIN SWITCH	1	
11	98580-06025-00	SCREW, PAN HEAD	1	
12	92995-06100-00	WASHER, SPRING	1	
13	97313-06030-00	BOLT	1	
14	92995-06100-00	WASHER, SPRING	1	
15	97313-06020-00	BOLT, HEXAGON	1	
16	92995-06100-00	WASHER, SPRING	1	
17	6Y5-83500-03-00	LCD TACH-TRIM-OIL	1	
18	6Y5-8353J-00-00	.GASKET, UPPER	1	
19	6Y5-8355X-01-00	.BRACKET METER 1	1	
20	6Y5-83586-00-00	.SOCKET ASSY	1	
21	10L-83517-00-00	.BULB (12V 2W)	1	
22	95301-04600-00	.NUT	2	
23	92901-04100-00	.WASHER, SPRING	2	
24	6Y5-83589-00-00	.GASKET	1	
25	6Y5-8350A-00-00	.LCD METER ASSEMBLY	1	
26	90164-03016-00	.SCREW, TAPPING	2	

27	6Y5-8357J-01-00	.DISPLAY UNIT	1	
28	6H2-82586-00-00	EXTENSION, WIRE LEAD	1	
29	90465-08M43-00	CLAMP	1	
30	6H5-83553-00-00	WIRE, LEAD	1	
31	688-83383-11-00	.BUZZER	1	
32	6H5-83386-00-00	BUZZER STAY	1	
33	97313-05010-00	BOLT, HEXAGON	2	
34	92990-05100-00	.WASHER, SPRING	2	
35	95380-05600-00	NUT	2	

Part Notes

P60TLHP 1991 / ELECTRIC PARTS 2

PART NUMBER		NOTE TEXT
682-82556-00-00		OEM: This part number is among the Top 100 Most Popular Marine Maintenance Parts as of March 2014.

©2014 Yamaha Motor Corporation, U.S.A. All rights reserved.

P60TLHP 1991 / OIL PUMP

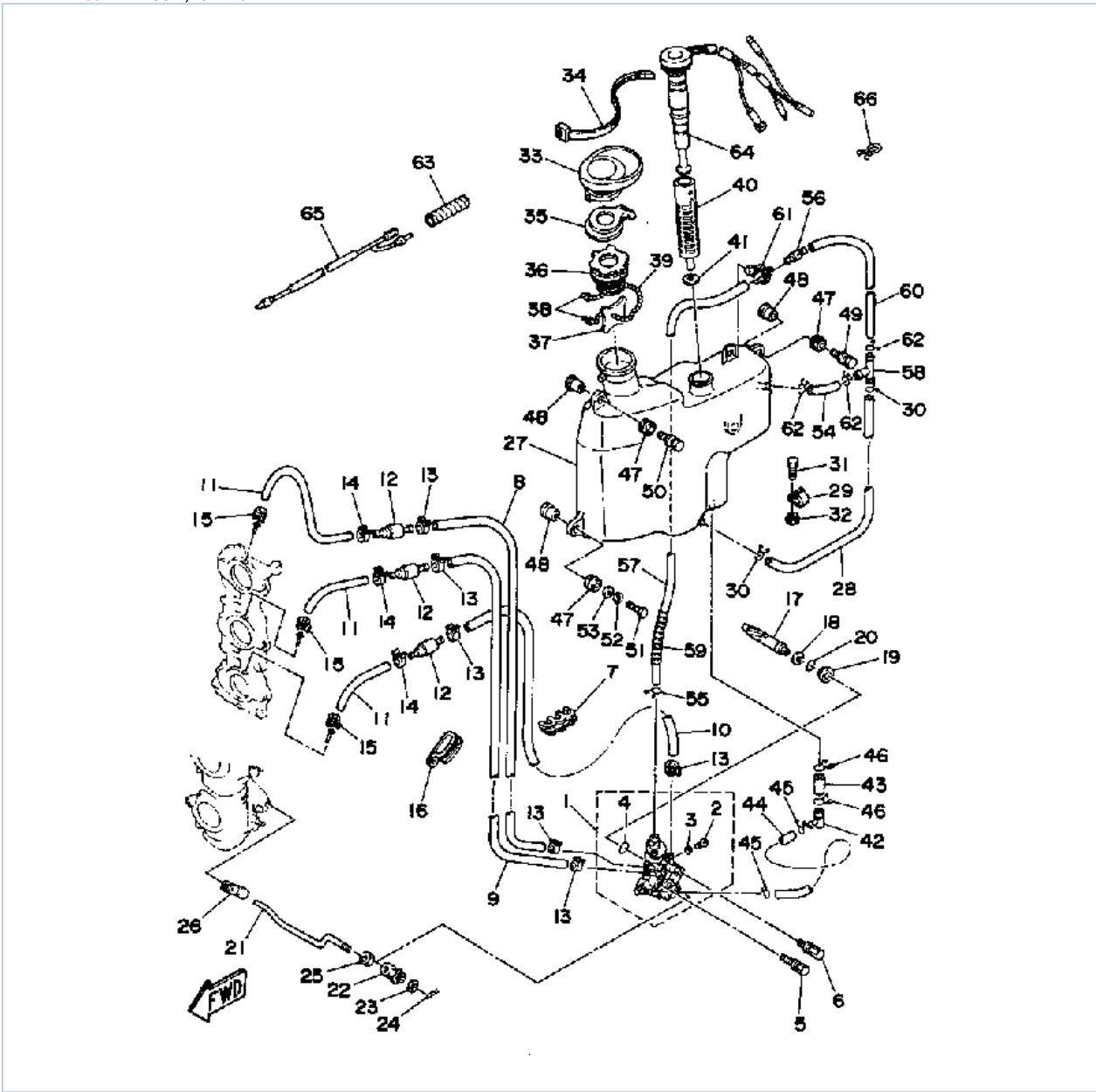

©2014 Yamaha Motor Corporation, U.S.A. All rights reserved.

Part List



P60TLHP 1991 / OIL PUMP

REF - NO	PART NUMBER	PART NAME	QUANTITY	REMARKS
1	6H3-13200-02-00	OIL INJECTION PUMP ASSY	1	
2	716-24444-00-00	.PLUG, DRAIN	1	
3	1YU-13187-00-00	.GASKET, BREATHER BOLT	1	
4	93210-19MA7-00	.O-RING	1	
5	90109-06M39-00	BOLT	1	
6	90109-06M40-00	BOLT	1	
7	90464-07M05-00	CLAMP	1	
8	90445-07MA4-00	HOSE (L280)	1	
9	90445-07M23-00	HOSE (L408)	1	
10	90445-07MA5-00	HOSE (L150)	1	
11	90445-07M87-00	HOSE (L110)	3	
12	6E9-13183-70-00	VALVE, CHECK	3	
13	90468-07M02-00	CLIP	1	
14	90468-07M02-00	CLIP	3	
15	90468-07M02-00	CLIP	3	
16	90465-08M23-00	CLAMP	1	
17	6H3-11537-01-00	GEAR, DRIVEN	1	
18	90201-08M93-00	WASHER, PLATE	1	
19	6H1-13117-01-00	COLLAR, DISTANCE	1	
20	93210-13595-00	O-RING	1	
21	6H3-41241-01-00	ROD, LINK	1	
22	6H1-41237-00-00	JOINT, LINK	1	
23	90202-05088-00	WASHER, PLATE	1	
24	90468-05M03-00	CLIP	1	
25	95380-05600-00	NUT	1	
26	6R5-41237-00-00	JOINT, LINK	1	
27	6H3-21707-06-00	OIL TANK COMP.	1	
28	90445-11M03-00	HOSE (L330)	1	
29	90465-11M27-00	CLAMP	1	
30	90467-11M08-00	CLIP	2	
31	97313-06016-00	BOLT, HEXAGON	1	
32	90387-06M31-00	.COLLAR	1	
33	6H3-21752-00-00	TUBE, FILLER 1	1	
34	90465-13M36-00	CLAMP	1	
35	6H1-2176M-01-00	HOOK	1	
36	6H4-21770-00-00	OIL TANK CAP ASSY	1	
37	6J8-21758-00-00	WASHER, SPECIAL 2	1	
38	6H1-21757-00-00	WASHER, SPECIAL 1	2	
39	6H1-24633-00-00	CHAIN, BALL	1	
40	6J8-13411-00-00	STRAINER, OIL	1	
41	6J8-13414-00-00	GASKET, STRAINER COVER	1	
42	6H1-13435-00-00	NIPPLE	1	
43	90445-08M01-00	HOSE (L30)	1	
44	6H1-21766-01-00	PIPE, OIL	1	
45	90467-08004-00	CLIP	2	
46	90467-12M11-00	CLIP	2	
47	6A0-82317-00-00	DAMPER, IGNITION COIL	4	
48	624-42542-00-00	PIPE	4	
49	90119-06M65-00	BOLT, WITH WASHER	2	
50	90119-06M64-00	BOLT, W/WASHER	1	
51	97395-06025-00	BOLT	1	
52	92990-06600-00	WASHER, PLATE	1	
53	90201-06M62-00	WASHER, PLATE	1	

54	90445-11M21-00	HOSE (L40)	1	
55	90467-10M04-00	CLIP	1	
56	6J8-21744-00-00	BREATHER	1	
57	90445-11M15-00	HOSE (L360)	1	
58	6E5-24378-00-00	PIPE, JOINT 3	1	
59	90446-10M01-00	HOSE (L60)	1	
60	90445-11M02-00	HOSE (L100)	1	
61	90464-11M23-00	CLAMP	1	
62	90467-11M08-00	CLIP	3	
63	90446-10M02-00	HOSE	1	
64	6H3-85720-14-00	OIL LVL GAUGE ASSEMBLY	1	
65	6H3-81315-00-00	LEAD WIRE ASSEMBLY	1	
66	90465-18147-00	CLAMP	1	

Part Notes

P60TLHP 1991 / OIL PUMP

PART NUMBER		NOTE TEXT
6H1-41237-00-00		OEM: This part number is among the Top 100 Most Popular Marine Maintenance Parts as of March 2014.
92990-06600-00		OEM: This part number is among the Top 100 Most Popular Marine Maintenance Parts as of March 2014.

©2014 Yamaha Motor Corporation, U.S.A. All rights reserved.

P60TLHP 1991 / REPAIR KIT

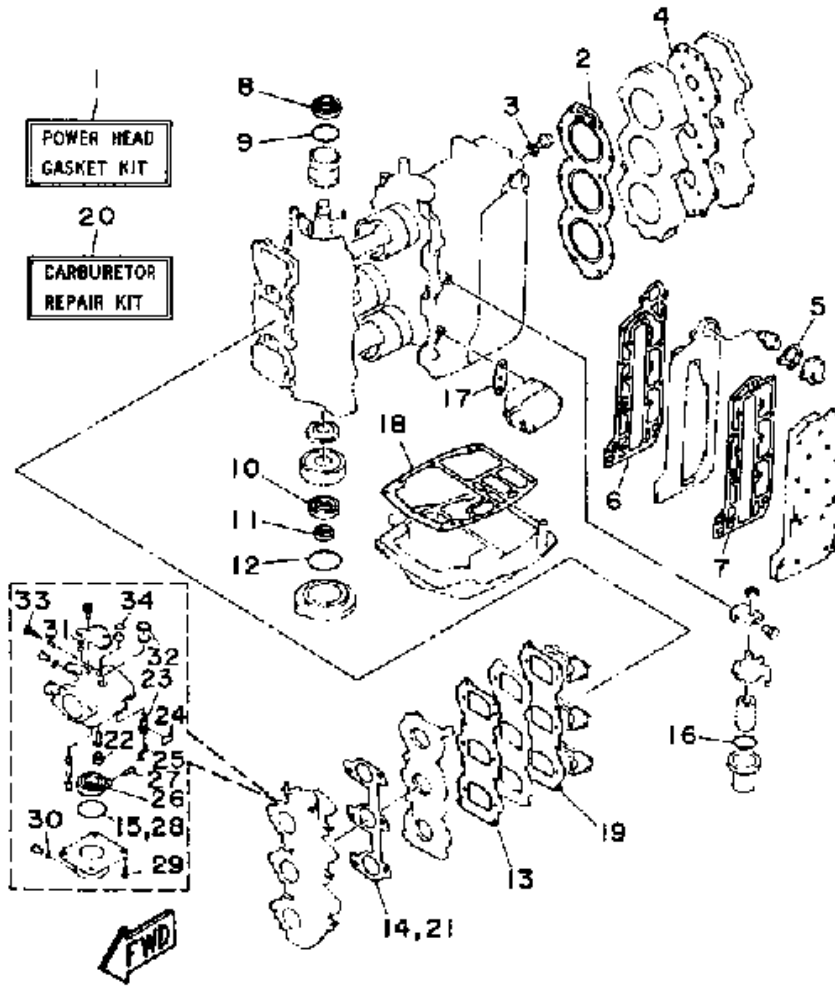

©2014 Yamaha Motor Corporation, U.S.A. All rights reserved.

Part List

P60TLHP 1991 / REPAIR KIT

REF - NO	PART NUMBER	PART NAME	QUANTITY	REMARKS
1	6H3-W0001-00-00	POWER HEAD GASKET KIT	1	
2	6H3-11181-A0-00	.GASKET, CYLINDER HEAD 1	1	
3	90430-14115-00	.GASKET	1	
4	6H3-11193-A1-00	.GASKET, HEAD COVER 1	1	
5	6H3-12414-A1-00	.GASKET, COVER	1	
6	6H3-41112-01-00	.GASKET, EXHAUST	1	
7	6H3-41114-A0-00	.GASKET, EXHAUST OUTER COVER	1	
8	93102-36M24-00	.OIL SEAL	1	
9	93210-46M16-00	.O-RING	1	
10	93102-30M23-00	.OIL SEAL	1	
11	93106-18M01-00	.OIL SEAL	1	
12	93210-65M50-00	.O-RING	1	
13	6H3-13621-00-00	.GASKET, VALVE SEAT	1	
14	6H3-14198-01-00	.GASKET	1	
15	6G1-14984-00-00	.O-RING	3	
16	93210-37M25-00	.O-RING	1	
17	650-24431-A0-00	.GASKET, FUEL PUMP 1	1	
18	6H3-45113-A0-00	.GASKET, UPPER CASING	1	
19	6H3-13622-00-00	.PACKING, VALVE SEAT	1	
20	6H3-W0093-01-00	CARBURETOR REPAIR KIT	1	
21	6H3-14198-01-00	.GASKET	1	
22	676-14966-00-00	.CAP	3	
23	6H3-14590-00-00	.NEEDLE VALVE ASSEMBLY	3	
24	663-14159-00-00	.CLIP	3	
25	676-14186-00-00	.PIN, FLOAT	3	
26	6G1-14985-00-00	.FLOAT	3	
27	688-14548-00-00	.PIN, FLOAT ARM	3	
28	6G1-14984-00-00	.O-RING	3	
29	97980-04114-00	.SCREW, WITH WASHER	3	
30	93210-04230-00	.O-RING	3	
31	663-14126-00-00	.GASKET	3	
32	688-14126-00-00	.GASKET	3	
33	692-14923-00-00	.SCREW, PILOT	3	
34	93210-15M52-00	.O-RING	3	

Part Notes

P60TLHP 1991 / REPAIR KIT

PART NUMBER	NOTE TEXT
650-24431-A0-00 	OEM: This part number is among the Top 100 Most Popular Marine Maintenance Parts as of March 2014.

©2014 Yamaha Motor Corporation, U.S.A. All rights reserved.

P60TLHP 1991 / REPAIR KIT 2

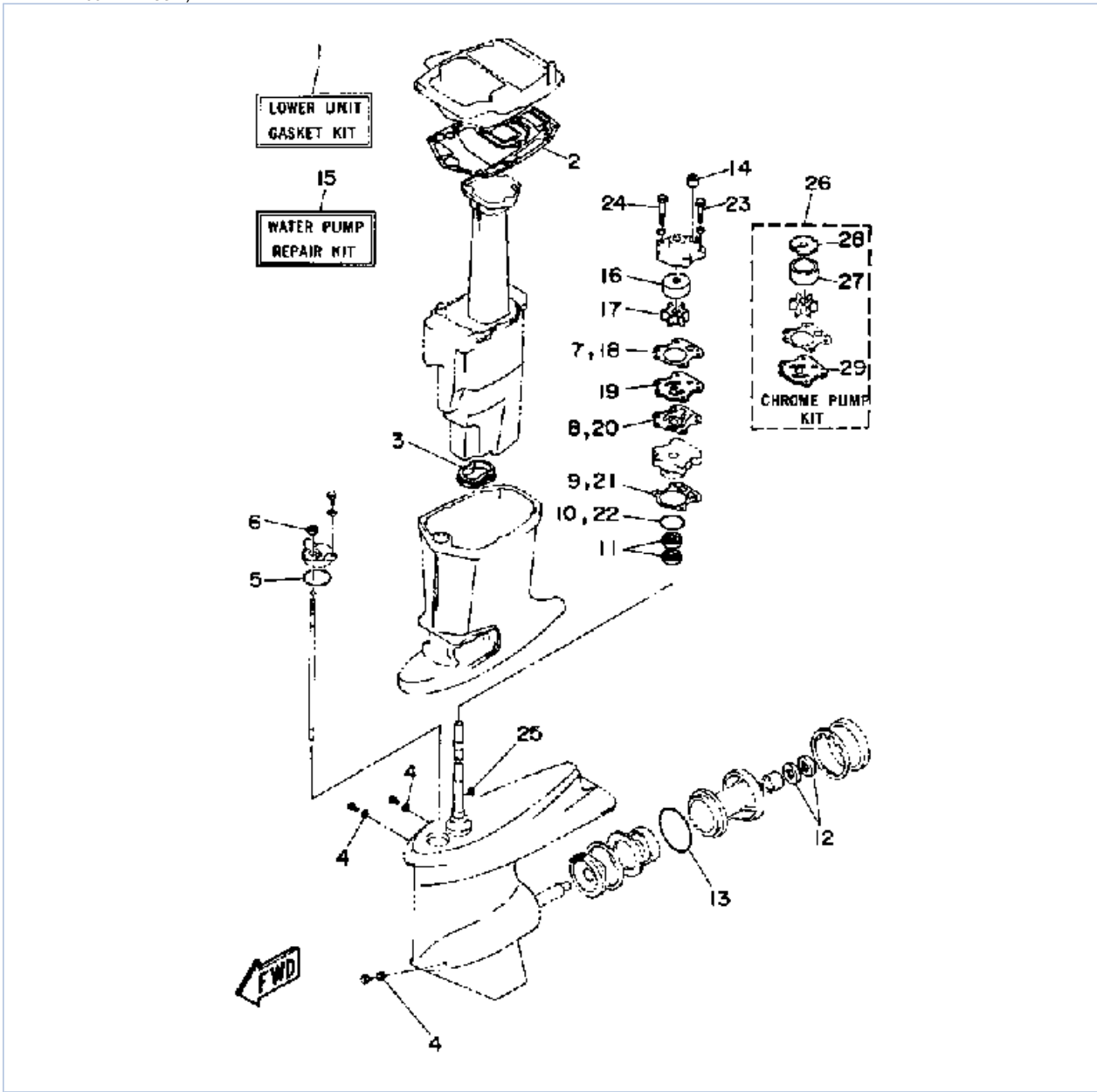

©2014 Yamaha Motor Corporation, U.S.A. All rights reserved.





Part List

P60TLHP 1991 / REPAIR KIT 2

REF - NO	PART NUMBER	PART NAME	QUANTITY	REMARKS
1	6H3-W0001-21-00	LOWER UNIT GASKET KIT	1	
2	6H3-45114-A1-00	.GASKET, UPPER CASING	1	
3	6H3-45123-00-00	.GASKET, MUFFLER	1	
4	90430-08020-00	.GASKET	3	
5	93210-49046-00	.O-RING	1	
6	93106-09014-00	.OIL SEAL	1	
7	6H3-44315-00-00	.GASKET, WATER PUMP	1	
8	6H3-44324-A0-00	.GASKET, CARTRIDGE	1	
9	688-44316-A0-00	.GASKET, WATER PUMP	1	
10	93210-46044-00	.O-RING	1	
11	93101-23070-00	.OIL SEAL	2	
12	93101-25M03-00	.OIL SEAL	2	
13	93210-85M97-00	.O-RING	1	
14	663-44366-00-00	.DAMPER, WATER SEAL 2	1	
15	6H3-W0078-00-00	WATER PUMP REPAIR KIT	1	
16	663-44322-00-00	.INSERT, CARTRIDGE	1	
17	6H3-44352-00-00	.IMPELLER	1	
18	6H3-44315-00-00	.GASKET, WATER PUMP	1	
19	6H3-44323-00-00	.OUTER PLATE, CARTRIDGE	1	
20	6H3-44324-A0-00	.GASKET, CARTRIDGE	1	
21	688-44316-A0-00	.GASKET, WATER PUMP	1	
22	93210-46044-00	.O-RING	1	
23	97395-08045-00	.BOLT	2	
24	97395-08055-00	.BOLT	2	
25	90280-03M03-00	.KEY, WOODRUFF	1	
26	6H3-W0078-0A-00	CHROME PUMP KIT	1	
27	670-44322-01-00	.INSERT, CARTRIDGE	1	
28	670-44321-00-00	.INNER PLATE, CARTRIDGE	1	
29	6H3-44323-40-00	.OUTER PLATE, CARTRIDGE	1	

Part Notes

P60TLHP 1991 / REPAIR KIT 2

PART NUMBER	NOTE TEXT
90430-08020-00 	OEM: This part number is among the Top 100 Most Popular Marine Maintenance Parts as of March 2014.
93106-09014-00 	OEM: This part number is among the Top 100 Most Popular Marine Maintenance Parts as of March 2014.
93101-25M03-00 	OEM: This part number is among the Top 100 Most Popular Marine Maintenance Parts as of March 2014.
6H3-44352-00-00 	OEM: This part number is among the Top 100 Most Popular Marine Maintenance Parts as of March 2014.

©2014 Yamaha Motor Corporation, U.S.A. All rights reserved.

©2014 Yamaha Motor Corporation, U.S.A. All rights reserved.