

5MSHW 1998 / CYLINDER CRANKCASE

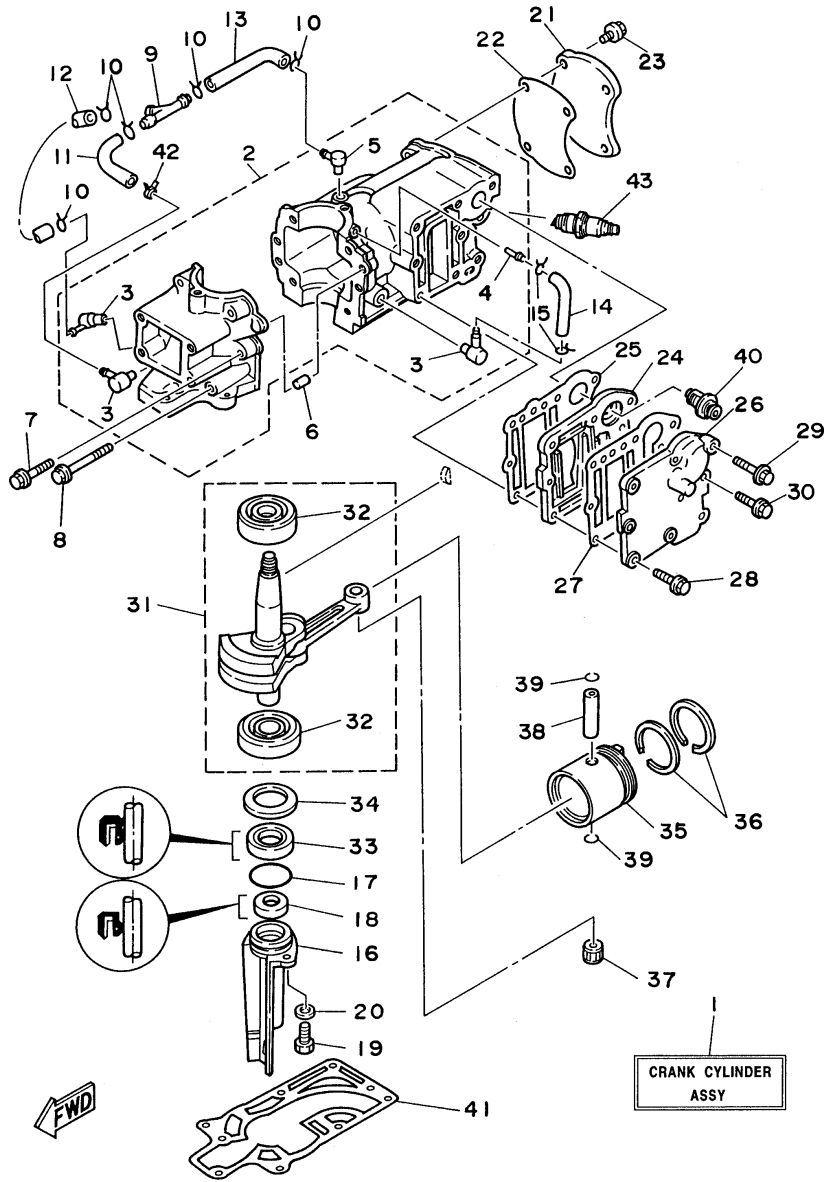

©2014 Yamaha Motor Corporation, U.S.A. All rights reserved.

Part List

5MSHW 1998 / CYLINDER CRANKCASE

REF - NO	PART NUMBER	PART NAME	QUANTITY	REMARKS
1	6E0-W0090-04-4D	CRANK CYLINDER ASSEMBLY (REF. NO. 2~42)	1	
1	6E3-W0090-04-4D	CRANK CYLINDER ASSEMBLY (REF. NO. 2~42)	1	
2	6E3-15100-02-94	CRANKSHAFT ASSEMBLY	1	UR 5MH
2	6E0-15100-01-94	CRANKCASE ASSEMBLY	1	UR 4MH
3	650-11370-00-00	.CHECK VALVE ASSY	3	
4	624-14485-00-00	.PIPE, JOINT	1	
5	6E5-11372-00-00	.NIPPLE, HOSE	1	
6	93606-12019-00	.PIN, DOWEL	2	
7	90105-06M16-00	BOLT, FLANGE	4	
8	90105-06M17-00	BOLT, FLANGE	2	
9	6E0-24378-00-00	PIPE, JOINT 3	1	
10	90467-06016-00	CLIP	5	
11	90445-07M00-00	HOSE (L100)	1	
12	90445-07M28-00	.HOSE (L70)	1	
13	90445-07M32-00	HOSE (L120)	1	
14	90445-07M28-00	.HOSE (L70)	1	
15	90467-06016-00	CLIP	2	
16	6E0-15396-03-5B	HOUSING, OIL SEAL	1	
17	93210-31114-00	O-RING	1	
18	93101-10M25-00	OIL SEAL	1	
19	97095-06016-00	BOLT	1	
20	92990-06600-00	WASHER, PLATE	1	
21	6E0-11191-01-9M	COVER, CYLINDER HEAD 1	1	UR 4MH
21	6E3-11191-01-9M	COVER, CYLINDER HEAD	1	UR 5MH
22	6E0-11193-A1-00	GASKET, HEAD COVER 1	1	UR 4MH
22	6E3-11193-A1-00	GASKET, HEAD COVER 1	1	UR 5MH
23	90105-06M14-00	BOLT FLANGE	4	
24	6E0-41111-01-9M	EXHAUST INNER COVER	1	UR 4MH
24	6E3-41111-01-9M	EXHAUST INNER COVER	1	UR 5MH
25	6E3-41112-A1-00	GASKET, EXHAUST INNER COVER	1	UR 5MH
25	6E0-41112-A1-00	GASKET, EXHAUST INNER COVER	1	UR 4MH
26	6E0-41113-01-9M	EXHAUST OUTER CVR.	1	UR 4MH
26	6E3-41113-01-9M	EXHAUST OUTER COVER	1	UR 5MH
27	6E0-41114-A1-00	GASKET, EXHAUST OUTER COVER	1	UR 4MH
27	6E3-41114-A1-00	GASKET, EXHAUST OUTER COVER	1	UR 5MH
28	90105-06M24-00	BOLT, FLANGE	7	
29	90105-06M24-00	BOLT, FLANGE	1	UR 5MH
29	90105-06M16-00	BOLT, FLANGE	1	UR 4MH
30	90105-06M14-00	BOLT FLANGE	1	
31	6E0-11400-00-00	CRANKSHAFT ASSEMBLY	1	UR 4MH
31	6E3-11400-00-00	CRANKSHAFT ASSY	1	UR 5MH
32	93306-204U0-00	.BEARING	2	
33	93101-20M29-00	OIL SEAL	1	
34	676-45567-00-09	SHIM, GEAR ADJUSTING. 0.9	1	
35	6E0-11631-00-98	PISTON (STD)	1	UR 4MH
35	6E3-11631-00-98	PISTON (STD)	1	UR 5MH
36	6J1-11610-00-00	PISTON RING SET (STD)	1	UR 5MH
36	6G1-11610-00-00	PISTON RINGSET (STD)	1	UR 4MH
37	93310-112V0-00	BEARING	1	
38	6G1-11633-00-00	PIN, PISTON	1	
39	93450-13022-00	CIRCLIP	2	
40	6E5-12411-01-00	THERMOSTAT	1	
41	6E0-45113-A1-00	GASKET, UPPER CASING	1	
42	90468-07M02-00	CLIP	1	
43	NGK-B7HS0-00-00	NGK SPARK PLUG B7HS	1	UR USA

Part Notes

5MSHW 1998 / CYLINDER CRANKCASE

PART NUMBER		NOTE TEXT
92990-06600-00		OEM: This part number is among the Top 100 Most Popular Marine Maintenance Parts as of March 2014.

©2014 Yamaha Motor Corporation, U.S.A. All rights reserved.

5MSHW 1998 / INTAKE

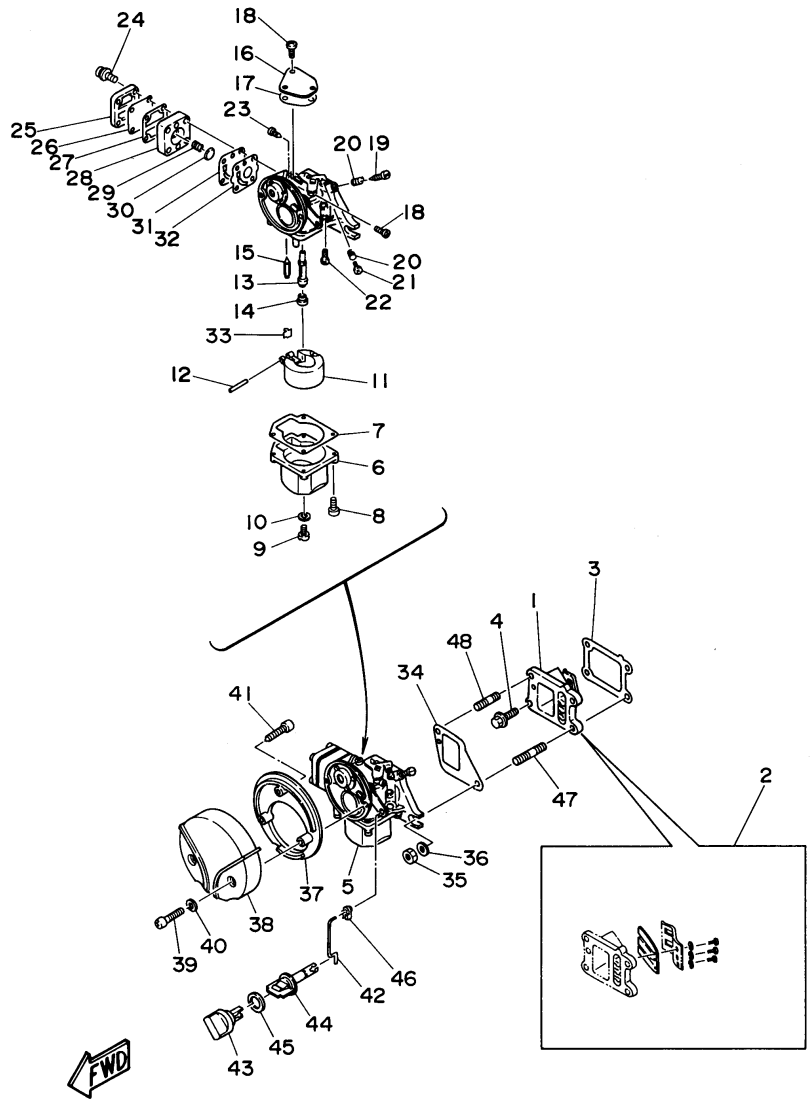

©2014 Yamaha Motor Corporation, U.S.A. All rights reserved.

Part List

5MSHW 1998 / INTAKE

REF - NO	PART NUMBER	PART NAME	QUANTITY	REMARKS
1	6E0-13610-00-00	REED VALVE ASSY	1	
2	6E0-W0004-00-00	.REED SET	1	
3	6E0-13621-A2-00	.GASKET, VALVE SEAT	1	
4	95895-06016-00	BOLT, FLANGE	2	
5	6E0-14301-05-00	CARBURETOR ASSEMBLY 1	1	UR 4MH
5	6E3-14301-05-00	CARBURETOR ASSEMBLY 1	1	UR 5MH
6	6E0-14381-02-00	.BODY, FLOAT CHAMBER	1	
7	6E0-14384-00-00	.GASKET, FLOAT CHAMBER	1	
8	97980-04116-00	.SCREW, WITH WASHER	4	
9	97890-05006-00	.SCREW, PAN HEAD	1	
10	646-14198-01-00	.GASKET	1	
11	6E7-14385-01-00	.FLOAT	1	
12	647-14386-10-00	.PIN, FLOAT	1	
13	6E0-14341-01-00	.NOZZLE, MAIN	1	UR 4MH
13	6E3-14341-02-00	.NOZZLE, MAIN	1	UR 5MH
14	648-14343-40-00	.JET, MAIN (# 80)	1	
15	6F5-14392-00-00	.VALVE, NEEDLE	1	
16	6E0-14157-00-00	.COVER, PLATE	1	
17	6E0-14227-00-00	.GASKET	1	
18	97890-04007-00	.SCREW, PAN HEAD	4	
19	647-14323-00-00	.SCREW, AIR ADJUSTING	1	
20	646-14212-01-00	.SPRING, PILOT ADJUSTING	2	
21	664-14321-01-00	.SCREW, THROTTLE	1	
22	648-14342-23-00	.JET, PILOT #XX	1	UR 4MH
22	648-14342-26-00	.JET, PILOT (#52)	1	UR 5MH
23	647-14326-00-00	.SCREW, GUIDE	1	
24	97980-04120-00	.SCREW, WITH WASHER	4	
25	6E0-24413-00-00	.COVER	1	
26	6E0-24471-00-00	.DIAPHRAGM	1	
27	6E0-24435-00-00	.GASKET, BODY 2	1	
28	6E0-24412-00-00	.BODY 1	1	
29	6E0-24423-00-00	.SPRING, DIAPHRAGM	1	
30	6E0-14346-00-00	.PLATE	1	
31	6E0-24411-00-00	.DIAPHRAGM	1	
32	6E0-24434-00-00	.GASKET, BODY	1	
33	6E0-14159-00-00	.CLIP	1	
34	6E0-14198-A0-00	GASKET	1	
35	95380-06700-00	NUT	2	
36	92990-06600-00	WASHER, PLATE	2	
37	6E0-14417-00-00	COVER 1	1	
38	6E0-14418-00-00	COVER 2	1	
39	98580-05525-00	SCREW, PAN HEAD	2	
40	92990-05600-00	WASHER, PLATE	2	
41	97780-40320-00	SCREW, TAPPING	1	
42	6E0-41256-00-00	ROD, CHOKE 1	1	
43	6E0-41271-00-00	KNOB, CHOKE	1	
44	6E0-41272-00-00	KNOB, CHOKE	1	
45	90202-12M16-00	WASHER, PLATE	1	
46	661-41262-02-00	JOINT, CHOKE LEVER	1	
47	95627-06325-00	BOLT, STUD	1	
48	90116-06M08-00	BOLT, STUD	1	

Part Notes

5MSHW 1998 / INTAKE

PART NUMBER	NOTE TEXT
92990-06600-00 	OEM: This part number is among the Top 100 Most Popular Marine Maintenance Parts as of March 2014.

©2014 Yamaha Motor Corporation, U.S.A. All rights reserved.

5MSHW 1998 / STARTER

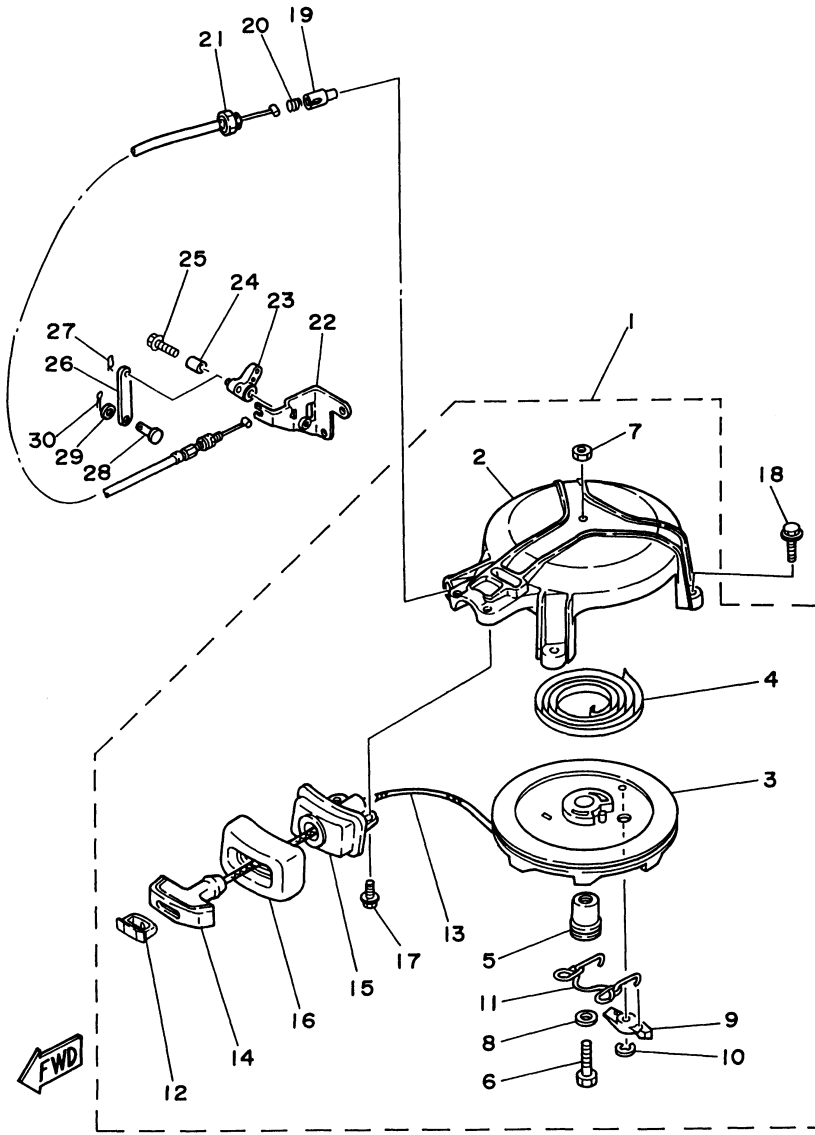

©2014 Yamaha Motor Corporation, U.S.A. All rights reserved.

Part List

5MSHW 1998 / STARTER

REF - NO	PART NUMBER	PART NAME	QUANTITY	REMARKS
1	6E4-15710-73-94	STARTER ASSY	1	
2	6E4-15711-71-94	.CASE, STARTER	1	
3	6E0-15714-01-00	.DRUM, SHEAVE	1	
4	90510-08M03-00	.SPRING, SPIRAL	1	
5	6E0-15717-00-00	.SHAFT, STARTER	1	
6	97014-06035-00	.BOLT, HEXAGON	1	
7	95604-06200-00	.NUT, U FLANGE	1	
8	90201-06M30-00	.WASHER, PLATE	1	
9	677-15741-01-00	.PAWL, DRIVE	1	
10	93430-06M02-00	.CIRCLIP	1	
11	6E0-15705-00-00	.SPRING, DRIVE PAWL	1	
12	6G1-15779-00-00	.COVER	1	
13	90580-40M02-00	.ROPE, STARTER	1	
14	6G1-15755-00-00	.HANDLE, STARTER	1	
15	6E0-15758-01-00	.GUIDE, ROPE	1	
16	6E0-15761-00-00	.SEAL, RUBBER 1	1	
17	95895-06016-00	.BOLT, FLANGE	2	
18	95895-06020-00	BOLT, FLANGE	3	
19	656-15748-00-00	PLUNGER, STARTER STOP	1	
20	90501-10227-00	SPRING, COMPRESSION	1	
21	6E4-15770-70-00	CABLE COMP., STARTER STOP	1	
22	6E4-15772-70-00	STAY 2	1	UR 5MH
22	6E0-15772-70-00	STAY 2	1	UR 4MH
23	6E4-15746-70-00	ARM	1	
24	90387-06504-00	COLLAR	1	
25	90119-06M18-00	BOLT, WITH WASHER	1	
26	6E4-15747-70-00	LINK	1	
27	90468-10005-00	CLIP	1	
28	91790-05010-00	PIN, CLEVIS	1	
29	90202-05088-00	WASHER, PLATE	1	
30	91490-16010-00	PIN. COTTER	1	

5MSHW 1998 / TOP COWLING

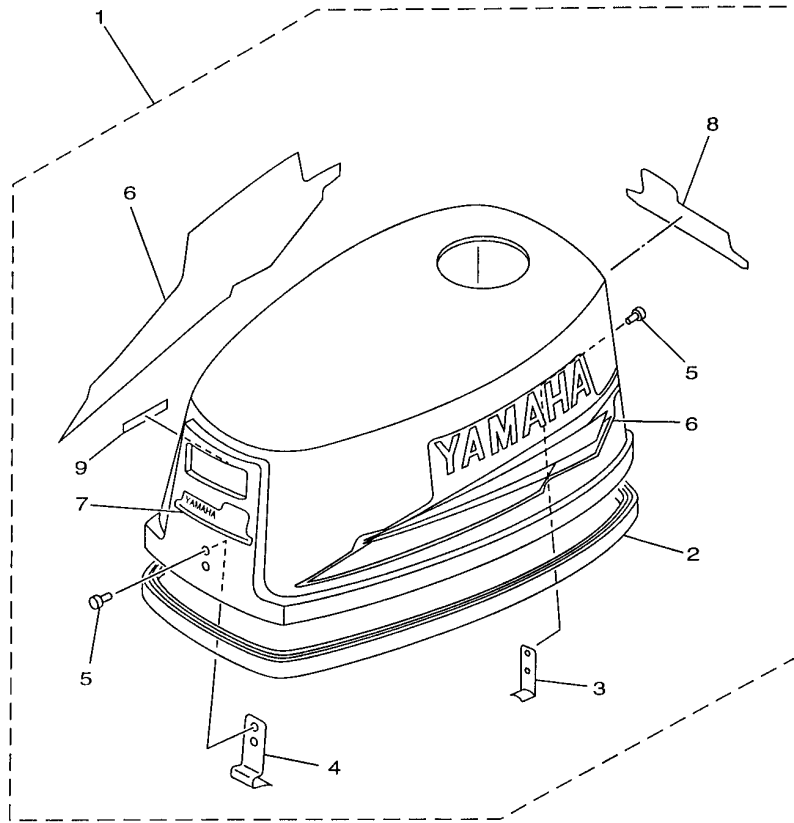

©2014 Yamaha Motor Corporation, U.S.A. All rights reserved.

Part List

5MSHW 1998 / TOP COWLING

REF - NO	PART NUMBER	PART NAME	QUANTITY	REMARKS
1	6E0-42610-15-4D	TOP COWLING ASSEMBLY	1	UR 4MH
1	6E3-42610-15-4D	TOP COWLING ASSY	1	UR 5MH
2	6E0-42615-00-00	.SEAL	1	
3	6E0-42647-01-00	.HOLDER, CLAMP BAND	1	
4	6E0-42651-02-00	.HOOK	1	
5	90266-04M00-00	.RIVET	4	
6	6E0-W0070-14-00	.GRAPHIC SET	1	
7	6E0-42677-11-00	.GRAPHIC, FRONT	1	UR 4MH
7	6E3-42677-11-00	.GRAPHIC, FRONT	1	UR 5MH
8	6E0-42678-12-00	.GRAPHIC, REAR	1	UR 4MH
8	6E3-42678-12-00	.GRAPHIC, REAR	1	UR 5MH
9	6E0-44191-11-00	.INDICATOR, SHIFT	1	

5MSHW 1998 / BOTTOM COWLING

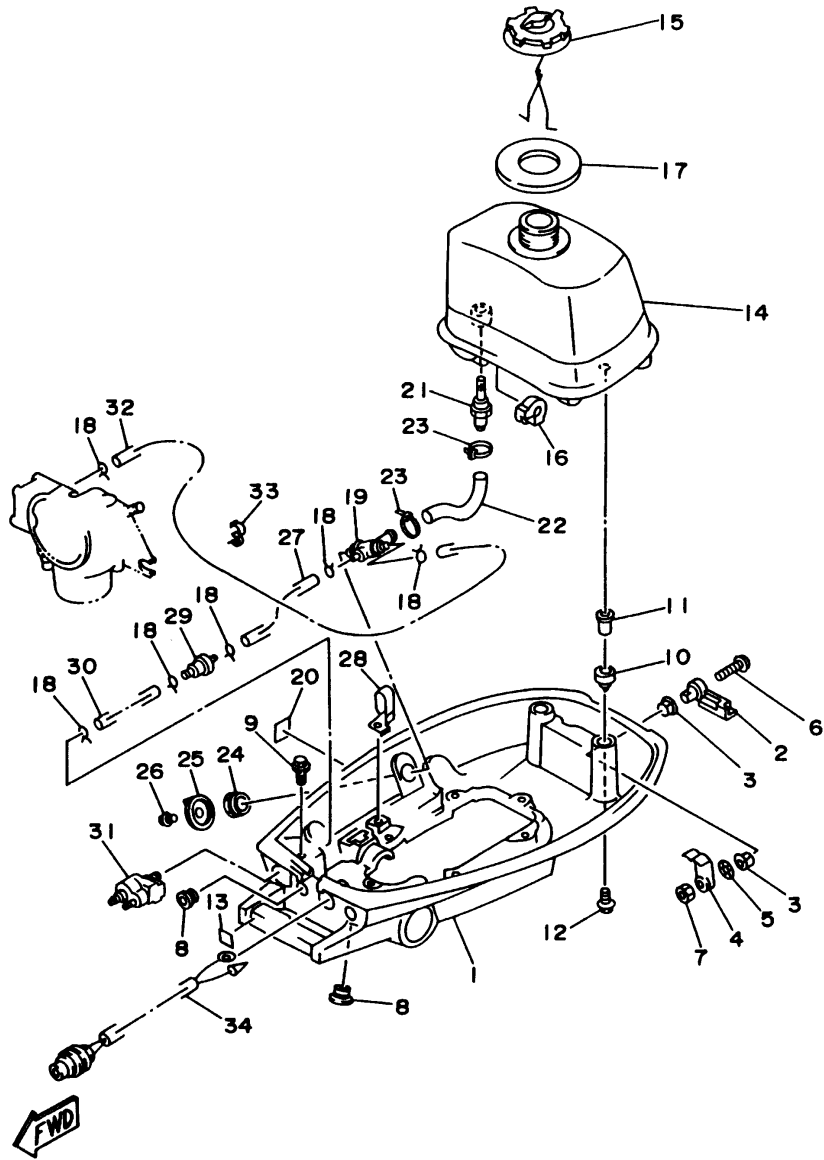

©2014 Yamaha Motor Corporation, U.S.A. All rights reserved.

Part List

5MSHW 1998 / BOTTOM COWLING

REF - NO	PART NUMBER	PART NAME	QUANTITY	REMARKS
1	6E0-42711-10-4D	COWLING, BOTTOM	1	
2	6E0-42815-00-4D	LEVER, CLAMP	1	
3	90386-12069-00	BUSH	2	
4	6E0-42816-00-00	LEVER, CLAMP	1	
5	90206-12052-00	WASHER, WAVE	1	
6	97885-06030-00	SCREW, PAN HEAD	1	
7	95380-06700-00	NUT	1	
8	90480-14M14-00	GROMMET	2	
9	95895-06020-00	BOLT, FLANGE	1	
10	6E3-24182-00-00	DAMPER, LOCATING 2	2	UR 5MH
10	6E0-24182-00-00	DAMPER, LOCATING 2	2	UR 4MH
11	6E0-42542-00-00	PIPE	2	
12	95895-06025-00	BOLT, FLANGE	2	
13	6A1-42792-01-00	MARK (100:1)	1	
14	6E0-24110-01-4D	FUEL TANK COMP.	1	
15	6E0-24610-02-00	CAP ASSY	1	
16	6E0-24181-00-00	DAMPER, LOCATING 1	2	
17	6E0-24641-00-00	GASKET, CAP 1	1	UR 4MH
17	6E3-24641-00-00	GASKET, CAP 1	1	UR 5MH
18	90467-08004-00	CLIP	6	
19	6E0-24500-10-00	FUEL COCK ASSY 1	1	
20	6E0-24591-10-00	EMBLEM, FUEL COCK	1	
21	6E0-24335-00-00	PIPE, SUCTION 1	1	
22	6E0-24311-00-00	PIPE, FUEL 1	1	
23	90465-13M11-00	CLAMP	2	
24	90170-16M35-00	NUT	1	
25	6J1-24524-00-00	LEVER, COCK	1	
26	90159-04M24-00	SCREW, WITH WASHER	1	
27	90445-09M27-00	HOSE (L125)	1	
28	90465-08M62-00	CLAMP	1	
29	646-24251-02-00	.STRAINER 1	1	
30	90445-09057-00	HOSE (L43)	1	
31	6G1-24304-02-00	FUEL PIPE JOINT COMP. 1	1	
32	6E0-24312-00-00	PIPE 2	1	
33	90464-09M21-00	CLAMP	1	
34	6E0-82550-01-00	ENGINE STOP SWITCH ASSY	1	UR

Part Notes

5MSHW 1998 / BOTTOM COWLING

PART NUMBER	NOTE TEXT
646-24251-02-00 	OEM: This part number is among the Top 100 Most Popular Marine Maintenance Parts as of March 2014.

©2014 Yamaha Motor Corporation, U.S.A. All rights reserved.

5MSHW 1998 / UPPER CASING BRACKET

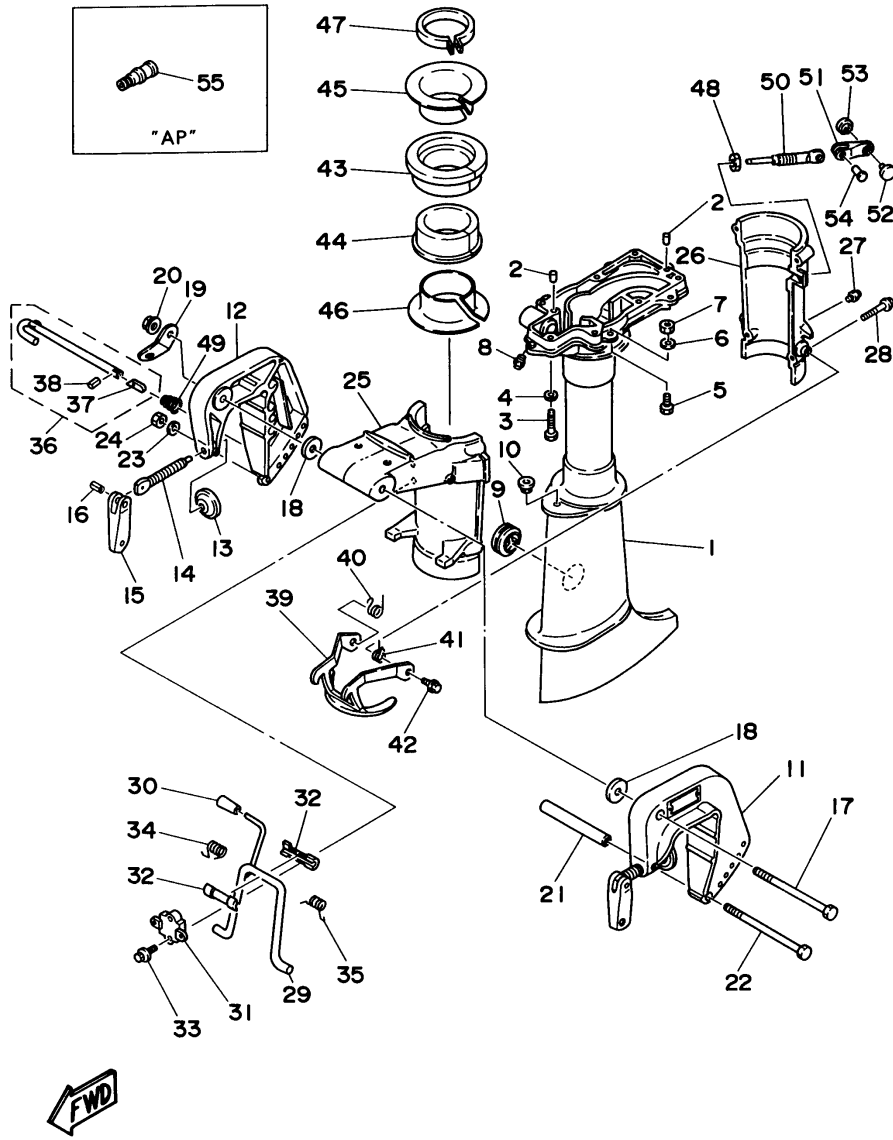

©2014 Yamaha Motor Corporation, U.S.A. All rights reserved.

Part List



5MSHW 1998 / UPPER CASING BRACKET

REF - NO	PART NUMBER	PART NAME	QUANTITY	REMARKS
1	6E0-45111-02-4D	CASING, UPPER	1	UR SHORT
1	6E0-45111-12-4D	CASING, UPPER	1	UR LONG
2	93606-12019-00	.PIN, DOWEL	2	
3	97095-06030-00	BOLT	7	
4	92990-06600-00	WASHER, PLATE	7	
5	97095-06016-00	BOLT	4	
6	92990-06600-00	WASHER, PLATE	4	
7	95380-06700-00	NUT	4	
8	93700-06M03-00	NIPPLE, GREASE	1	
9	647-45151-01-00	COVER, UPPER CASING	1	
10	90480-10M13-00	GROMMET	1	
11	6E0-43111-02-4D	BRACKET, CLAMP	1	
12	6E0-43112-01-4D	BRACKET, CLAMP	1	
13	648-43114-01-00	PAD, TRANSOM CLAMP	2	
14	6E0-43116-01-00	SCREW, TRANSOM CLAMP	2	
15	6E0-43118-01-00	HANDLE, TRANSOM CLAMP	2	
16	90243-04M01-00	PIN	2	
17	90101-08M07-00	BOLT	1	
18	90201-08M03-00	WASHER, PLATE	2	
19	6A1-43113-01-00	PLATE, CLAMP BRACKET	1	
20	95780-08300-00	..NUT, FLANGE	1	
21	90387-06M11-00	COLLAR	1	
22	90101-06335-00	BOLT	1	
23	92990-06600-00	WASHER, PLATE	1	
24	95380-06600-00	NUT, HEXAGON	1	
25	6E0-43311-04-4D	BRACKET, SWIVEL 1	1	
26	6E0-43312-02-4D	BRACKET, SWIVEL 2	1	
27	93700-06M03-00	NIPPLE, GREASE	1	
28	95895-06035-00	BOLT, FLANGE	4	
29	6E0-43181-00-00	LEVER, TILT STOP	1	
30	6E0-43632-00-00	KNOB, TILT	1	
31	6E0-43313-00-94	BRACKET, SWIVEL 3	1	
32	620-43189-00-00	BUSHING	2	
33	95895-06020-00	BOLT, FLANGE	2	
34	90508-16020-00	SPRING, TORSION	1	
35	90508-16021-00	SPRING, TORSION	1	
36	6E0-43160-01-00	TILT ROD ASSY	1	
37	689-43165-00-00	.PLATE, TILT LOCK	1	
38	91690-30008-00	.PIN, SPRING	1	
39	6E0-43614-00-5B	PLATE, TILT LOCK	1	
40	90508-14M10-00	SPRING, TORSION	1	
41	90508-14M11-00	SPRING, TORSION	1	
42	95895-06010-00	BOLT, FLANGE	2	
43	6E0-42537-02-00	BUSHING, PIVOT SHAFT	1	
44	6E0-42538-02-00	BUSHING, PIVOT SHAFT	1	
45	6E0-42539-00-00	BUSHING, PIVOT SHAFT	1	
46	6E0-42549-00-00	BUSHING, PIVOT SHAFT	1	
47	6E0-42528-03-00	PLATE, FRICTION	1	
48	95380-08600-00	NUT	1	
49	90502-08M05-00	SPRING, CONICAL	1	
50	6L5-42529-01-00	SCREW, FRICTION PIECE	1	
51	6L5-42561-00-00	KNOB, STEERING LOCK	1	
52	6L5-44196-00-00	INDICATOR 3	1	
53	6L5-44197-00-00	INDICATOR 4	1	
54	90266-04M05-00	RIVET	1	
55	6E0-28193-00-94	PLUG, WATER CHECK	1	AP

Part Notes

5MSHW 1998 / UPPER CASING BRACKET

PART NUMBER	NOTE TEXT
-------------	-----------

92990-06600-00		OEM: This part number is among the Top 100 Most Popular Marine Maintenance Parts as of March 2014.
92990-06600-00		OEM: This part number is among the Top 100 Most Popular Marine Maintenance Parts as of March 2014.
92990-06600-00		OEM: This part number is among the Top 100 Most Popular Marine Maintenance Parts as of March 2014.

©2014 Yamaha Motor Corporation, U.S.A. All rights reserved.

5MSHW 1998 / CONTROL

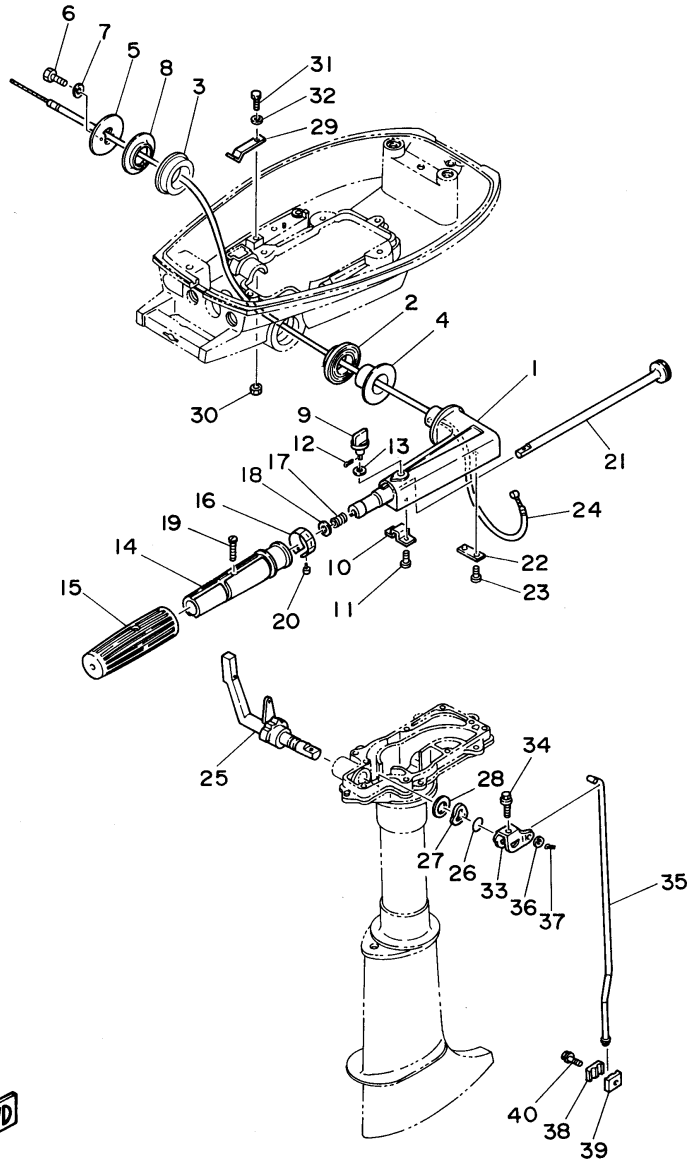

©2014 Yamaha Motor Corporation, U.S.A. All rights reserved.

Part List

5MSHW 1998 / CONTROL

REF - NO	PART NUMBER	PART NAME	QUANTITY	REMARKS
1	6E0-42111-02-4D	HANDLE, STEERING	1	
2	6E0-42129-02-00	BUSHING, RUBBER	1	
3	6E4-42129-00-00	BUSHING, RUBBER	1	
4	90386-26M30-00	BUSH	1	
5	6E0-42131-02-94	COVER, HANDLE STEERING	1	
6	97313-05020-00	BOLT, HEXAGON	2	
7	92990-05600-00	WASHER, PLATE	2	
8	90386-26M33-00	BUSH	1	
9	6E0-42125-00-00	BOLT, FRICTION ADJUSTING	1	
10	6E0-42134-02-00	COVER, THROTTLE LEVER	1	
11	97885-05012-00	SCREW, PAN HEAD	2	
12	91490-12012-00	PIN. COTTER	1	
13	90202-07M22-00	WASHER, PLATE	1	
14	6E0-42119-00-00	GRIP, STEERING HANDLE	1	
15	6E0-42177-00-00	RUBBER, HANDLE	1	
16	6E0-42137-10-00	INDICATOR, THROTTLE	1	
17	90501-23215-00	SPRING, COMPRESSION	1	
18	90201-10119-00	WASHER, PLATE	1	
19	90149-05M13-00	SCREW	1	
20	90269-02M09-00	RIVET	1	
21	6E0-42138-01-00	LEVER, THROTTLE	1	
22	6E0-42159-02-00	STAY	1	
23	97885-05012-00	SCREW, PAN HEAD	2	
24	6E0-26301-01-00	THROTTLE CABLE ASSY	1	
25	6E4-44111-72-4D	HANDLE, GEAR SHIFT	1	
26	93210-12790-00	O-RING	1	
27	90206-16M06-00	WASHER, WAVE	1	
28	90202-16061-00	WASHER, PLATE	1	
29	6E0-44116-00-00	SPRING	1	
30	95380-06700-00	NUT	1	
31	97095-06012-00	BOLT	1	
32	92990-06600-00	WASHER, PLATE	1	
33	6E0-44121-00-00	LEVER, SHIFT ROD	1	
34	95895-06025-00	BOLT, FLANGE	1	
35	6E0-44143-10-00	ROD, SHIFT	1	UR LONG
35	6E0-44143-00-00	ROD, SHIFT	1	UR SHORT
36	92990-05600-00	WASHER, PLATE	1	
37	91490-16010-00	PIN. COTTER	1	
38	6E0-44145-00-00	CONNECTOR, SHIFT ROD	1	
39	6E0-44146-00-00	CONNECTOR, SHIFT ROD	1	
40	95895-06020-00	BOLT, FLANGE	1	

Part Notes

5MSHW 1998 / CONTROL

PART NUMBER	NOTE TEXT
92990-06600-00 	OEM: This part number is among the Top 100 Most Popular Marine Maintenance Parts as of March 2014.

©2014 Yamaha Motor Corporation, U.S.A. All rights reserved.

5MSHW 1998 / LOWER CASING DRIVE 1

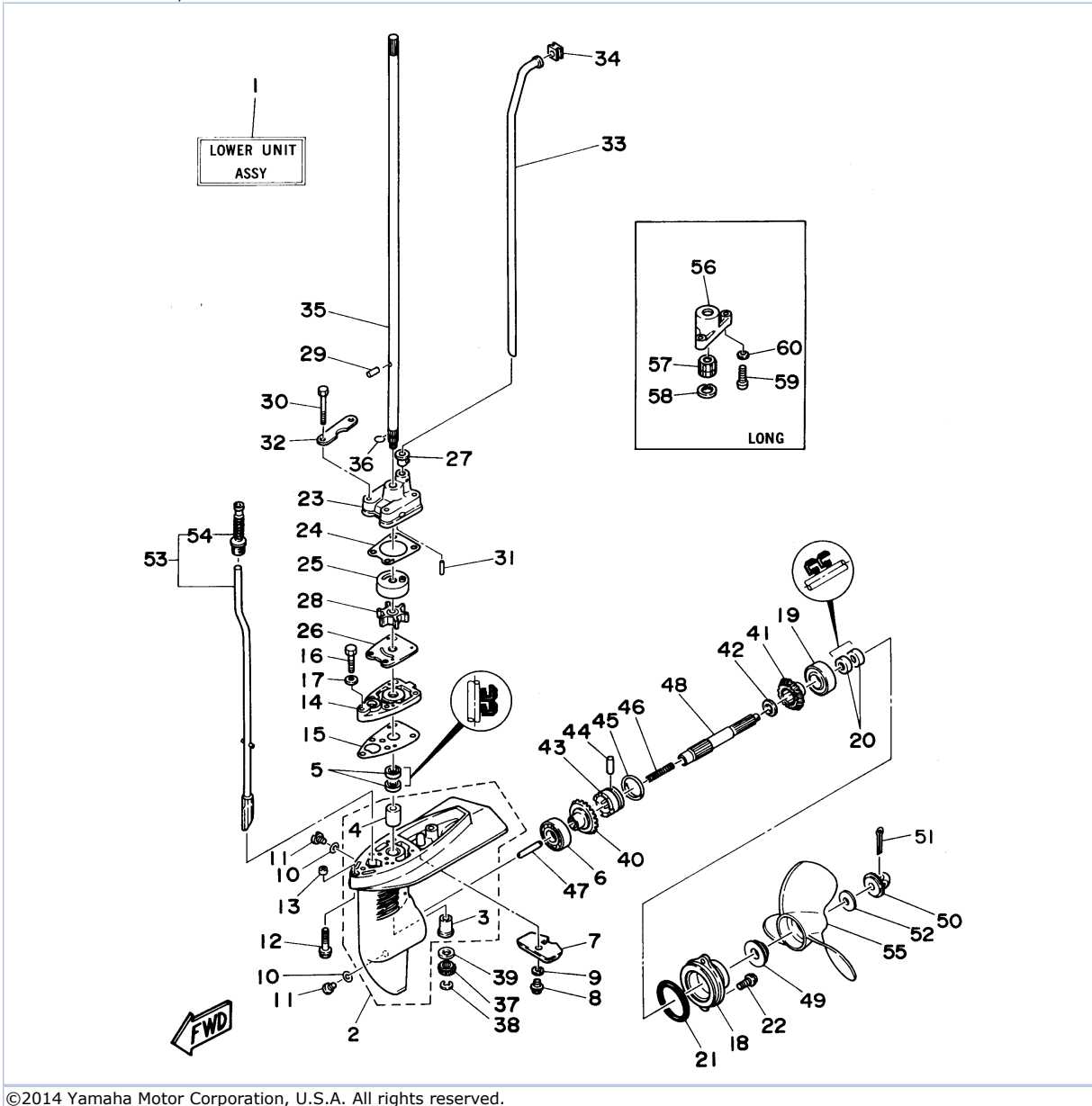

©2014 Yamaha Motor Corporation, U.S.A. All rights reserved.

Part List



5MSHW 1998 / LOWER CASING DRIVE 1

REF - NO	PART NUMBER	PART NAME	QUANTITY	REMARKS
1	6E0-45300-03-4D	LOWER UNIT ASSY	1	
1	6E0-45300-13-4D	LOWER UNIT ASSY	1	35~48 AND 53~54)
2	6E0-45311-02-4D	CASING, LOWER	1	
3	6E0-45317-09-00	.BUSHING, DRIVE SHAFT	1	
4	6E0-45316-09-00	.BUSHING, DRIVE SHAFT	1	
5	93101-10M14-00	.OIL SEAL	2	
6	93306-00426-00	BEARING	1	
7	6L5-45251-02-00	ANODE	1	
8	95895-06012-00	BOLT, FLANGE	1	
9	92990-06300-00	WASHER, INTERNAL TOOTH	1	
10	90430-08020-00	.GASKET	3	
11	90340-08M04-00	PLUG, STRAIGHT SCREW	3	
12	90119-06M40-00	BOLT, WITH WASHER	2	
13	90387-06M14-00	COLLAR	2	
14	6E0-45321-01-5B	PLATE	1	
15	6E0-45315-A0-00	.PACKING, LOWER CASING	1	
16	97095-06025-00	BOLT	1	
17	92990-06600-00	WASHER, PLATE	1	
18	6E0-45361-01-4D	CAP, LOWER CASING	1	
19	93306-00426-00	BEARING	1	
20	93101-13M12-00	.OIL SEAL	2	
21	93210-48214-00	.O-RING	1	
22	95895-06016-00	BOLT, FLANGE	2	
23	6E0-44311-00-00	HOUSING, WATER PUMP	1	
24	6E0-44315-A0-00	.GASKET, WATER PUMP	1	
25	6E0-44322-02-00	INSERT, CARTRIDGE	1	
26	6E0-44323-00-00	OUTER PLATE, CARTRIDGE	1	
27	6E0-44366-00-00	DAMPER, WATER SEAL 2	1	
28	6E0-44352-00-00	IMPELLER	1	
29	93604-09066-00	PIN, DOWEL	1	
30	97095-06045-00	.BOLT	4	
31	93604-18080-00	.PIN, DOWEL	2	
32	6E0-44328-00-00	PLATE	2	
33	6E0-44361-00-00	TUBE, WATER	1	UR SHORT
33	6E0-44361-10-00	TUBE, WATER	1	UR LONG
34	646-44365-00-00	DAMPER, WATER SEAL	1	
35	6E0-45511-00-00	SHAFT, DRIVE (SHORT)	1	UR SHORT
35	6E0-45511-10-00	DRIVE SHAFT (LONG)	1	UR LONG
36	90467-08M01-00	CLIP	1	
37	6E0-45551-00-00	PINION (13T)	1	
38	99009-06600-00	CIRCLIP	1	
39	90201-11M49-00	WASHER, PLATE	1	
40	6E0-45560-00-00	GEAR	1	
41	6E0-45570-00-00	GEAR	1	
42	90201-13M50-00	WASHER, PLATE	1	
43	6E0-45631-00-00	CLUTCH, DOG	1	
44	90250-05046-00	PIN, STRAIGHT	1	
45	654-45633-00-00	RING, CROSS PIN	1	
46	90501-10064-00	SPRING, COMPRESSION	1	
47	654-45635-00-00	PLUNGER, SHIFT	1	
48	6E0-45611-01-00	SHAFT, PROPELLER	1	
49	6L5-45987-01-00	SPACER	1	
50	6L5-45616-00-00	NUT, PROPELLER	1	
51	91490-25030-00	PIN. COTTER	1	
52	90201-08M54-00	WASHER, PLATE	1	
53	6E0-44150-00-00	SHIFT CAM ASSY	1	UR SHORT
53	6E0-44150-10-00	SHIFT CAM ASSY	1	UR LONG
54	6G1-44147-00-00	.BOOT, SHIFT ROD	1	
55	6E0-45943-01-EL	PROPELLER (3X7-1/2"X7"-BA)	1	UR

55	6E0-45949-00-EL	PROPELLER (3X7-1/4"X6-1/2"-BA)	1	UR
55	6E0-45941-01-EL	PROPELLER (3X7-1/2"X8"-BA)	1	UR
56	6E0-45331-00-5B	HOUSING, BEARING	1	LONG
57	6E0-45318-01-00	BUSHING, DRIVE SHAFT	1	LONG
58	93420-22M03-00	CIRCLIP	1	LONG
59	98580-05525-00	SCREW, PAN HEAD	2	LONG
60	92990-05600-00	WASHER, PLATE	2	LONG

Part Notes

5MSHW 1998 / LOWER CASING DRIVE 1

PART NUMBER		NOTE TEXT
90430-08020-00		OEM: This part number is among the Top 100 Most Popular Marine Maintenance Parts as of March 2014.
92990-06600-00		OEM: This part number is among the Top 100 Most Popular Marine Maintenance Parts as of March 2014.

©2014 Yamaha Motor Corporation, U.S.A. All rights reserved.

5MSHW 1998 / GENERATOR

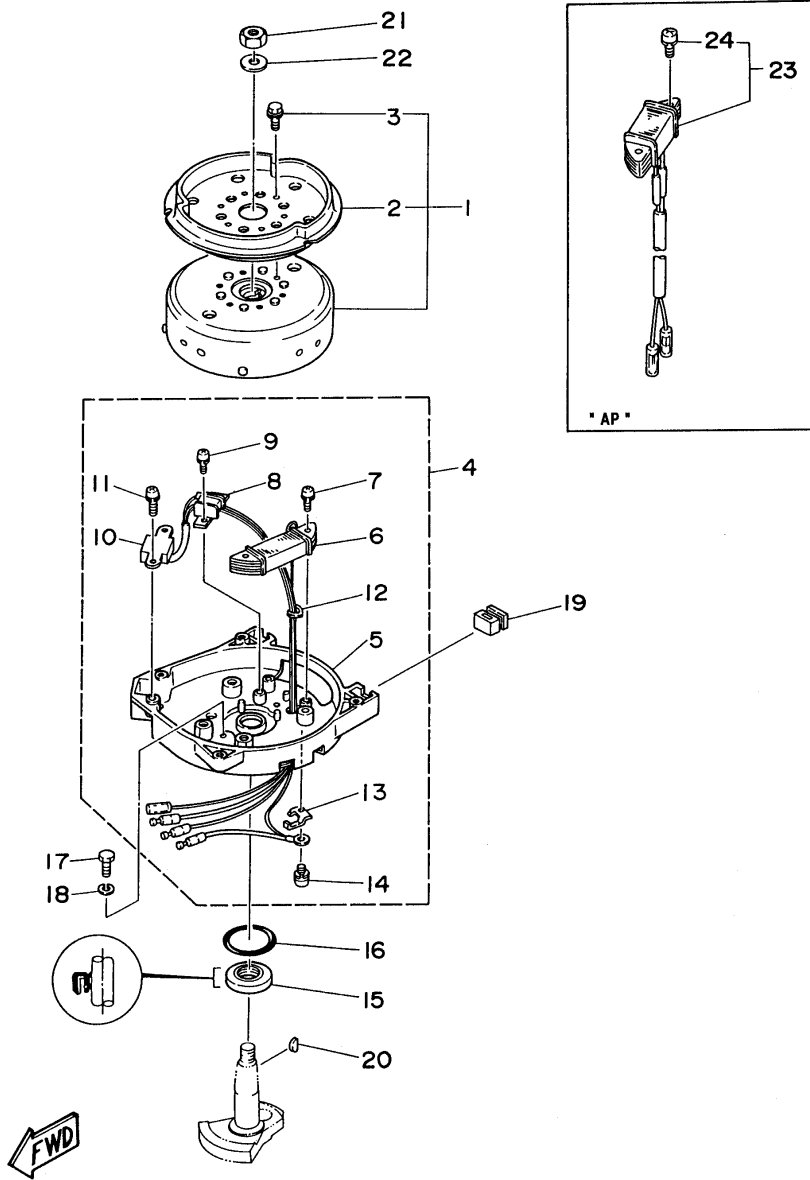

©2014 Yamaha Motor Corporation, U.S.A. All rights reserved.

Part List

5MSHW 1998 / GENERATOR

REF - NO	PART NUMBER	PART NAME	QUANTITY	REMARKS
1	6E0-85550-71-00	ROTOR ASSY	1	
2	6E0-15723-00-94	.PULLEY, STARTER	1	
3	90105-06M14-00	.BOLT FLANGE	3	
4	6E0-85560-70-00	BASE ASSY	1	
5	6E0-15359-00-94	.HOUSING, OIL SEAL	1	
6	6E0-85520-70-00	.COIL, CHARGE	1	
7	90159-05038-00	.SCREW, WITH WASHER	2	
8	6E0-85595-70-00	.COIL, PULSER	1	
9	90159-04036-00	.SCREW, WITH WASHER	2	
10	6E0-85592-70-00	.PULSER COIL ASSY	1	
11	90159-05037-00	.SCREW, WITH WASHER	2	
12	6E0-81336-70-00	.GROMMET	1	
13	6E0-81328-70-00	.CLAMP	1	
14	90159-04035-00	.SCREW, WITH WASHER	1	
15	93102-20M25-00	OIL SEAL	1	
16	93210-42159-00	.O-RING	1	
17	97095-06016-00	BOLT	2	
18	92995-06100-00	WASHER, SPRING	2	
19	6E0-24183-00-00	DAMPER, LOCATING 3	2	
20	90280-04M06-00	KEY, WOODRUFF	1	
21	90170-10113-00	NUT	1	
22	90201-102G9-00	WASHER, PLATE	1	
23	6E0-81303-80-00	LIGHTING COIL ASSY	1	AP
24	90159-05039-00	.SCREW, W/WASHER	2	

5MSHW 1998 / ELECTRICAL 1

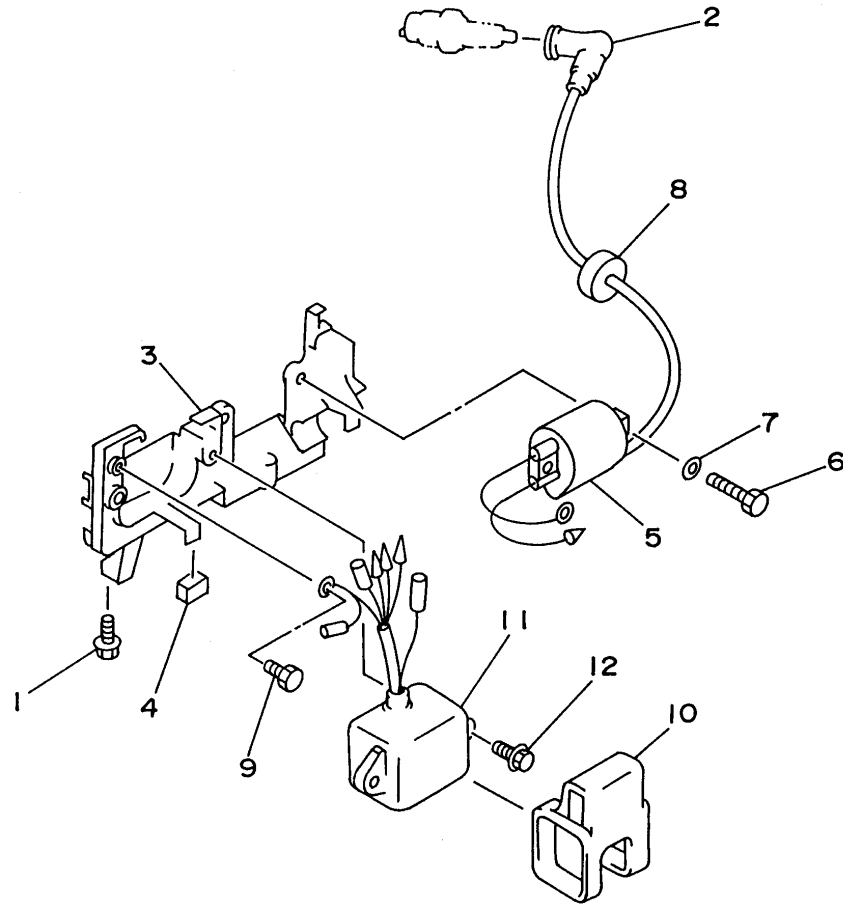

©2014 Yamaha Motor Corporation, U.S.A. All rights reserved.

Part List

5MSHW 1998 / ELECTRICAL 1

REF - NO	PART NUMBER	PART NAME	QUANTITY	REMARKS
1	95895-06016-00	BOLT, FLANGE	2	
2	663-82370-01-00	PLUG CAP ASSY	1	UR
3	6E0-82316-01-94	BRACKET, IGNITION COIL	1	
4	6E0-82317-00-00	DAMPER, IGNITION COIL	2	
5	6E0-85570-00-00	IGNITION COIL ASSY	1	
6	97095-06016-00	BOLT	2	
7	92990-06600-00	WASHER, PLATE	2	
8	90480-25161-00	GROMMET	1	
9	97095-06010-00	BOLT	1	
10	6E0-85548-00-00	HOLDER	1	
11	6E0-85540-71-00	C.D.I. UNIT ASSY	1	
12	95895-06020-00	BOLT, FLANGE	2	

Part Notes

5MSHW 1998 / ELECTRICAL 1

PART NUMBER	NOTE TEXT
92990-06600-00 	OEM: This part number is among the Top 100 Most Popular Marine Maintenance Parts as of March 2014.

©2014 Yamaha Motor Corporation, U.S.A. All rights reserved.

5MSHW 1998 / REPAIR KIT

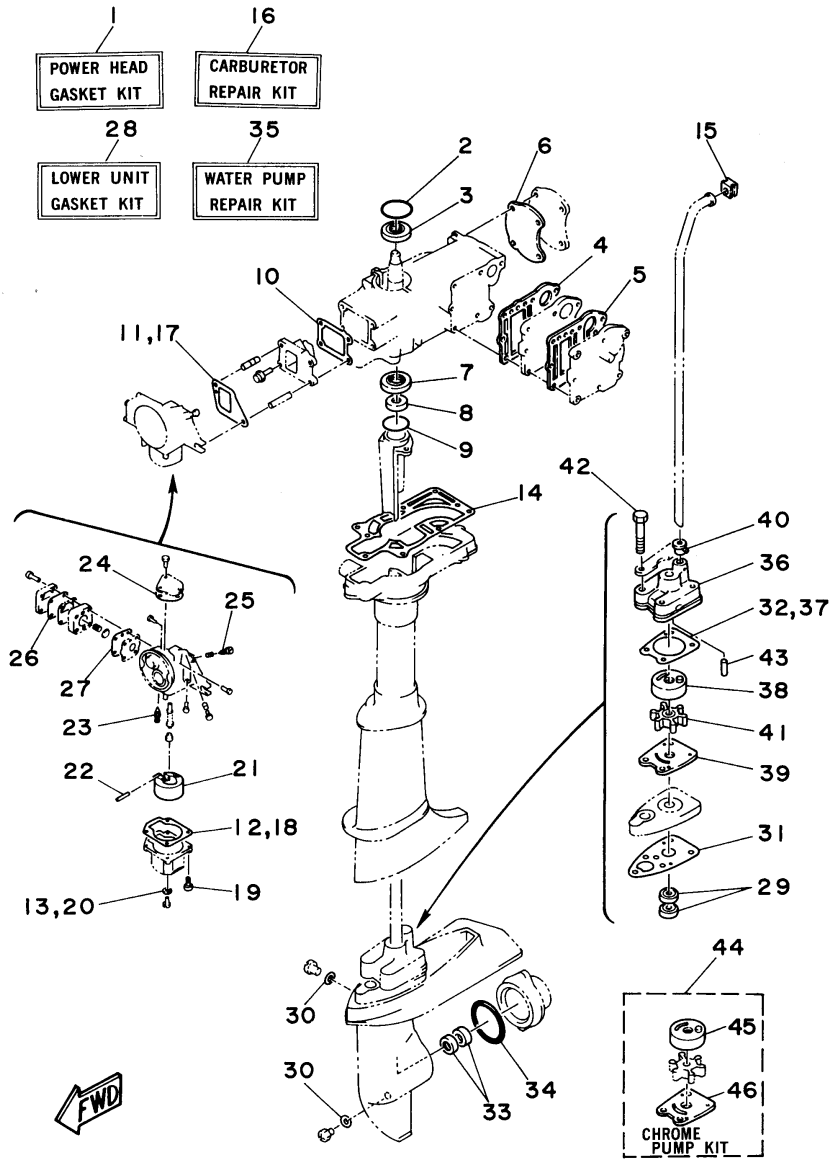

©2014 Yamaha Motor Corporation, U.S.A. All rights reserved.

Part List

5MSHW 1998 / REPAIR KIT

REF - NO	PART NUMBER	PART NAME	QUANTITY	REMARKS
1	6E0-W0001-A3-00	POWER HEAD GASKET KIT	1	UR 4MH
1	6E3-W0001-A3-00	POWER HEAD GASKET KIT	1	UR 5MH
2	93210-42159-00	.O-RING	1	
3	93102-20M25-00	.OIL SEAL	1	
4	6E0-41112-A1-00	.GASKET, EXHAUST INNER COVER	1	UR 4MH
4	6E3-41112-A1-00	.GASKET, EXHAUST INNER COVER	1	UR 5MH
5	6E0-41114-A1-00	.GASKET, EXHAUST OUTER COVER	1	UR 4MH
5	6E3-41114-A1-00	.GASKET, EXHAUST OUTER COVER	1	UR 5MH
6	6E3-11193-A1-00	.GASKET, HEAD COVER 1	1	UR 5MH
6	6E0-11193-A1-00	.GASKET, HEAD COVER 1	1	UR 4MH
7	93101-20M29-00	.OIL SEAL	1	
8	93101-10M25-00	.OIL SEAL	1	
9	93210-31114-00	.O-RING	1	
10	6E0-13621-A2-00	.GASKET, VALVE SEAT	1	
11	6E0-14198-A0-00	.GASKET	1	
12	6E0-14384-00-00	.GASKET, FLOAT CHAMBER	1	
13	646-14198-01-00	.GASKET	1	
14	6E0-45113-A1-00	.GASKET, UPPER CASING	1	
15	646-44365-00-00	.DAMPER, WATER SEAL	1	
16	6E0-W0093-04-00	CARBURETOR REPAIR KIT	1	
17	6E0-14198-A0-00	.GASKET	1	
18	6E0-14384-00-00	.GASKET, FLOAT CHAMBER	1	
19	97980-04116-00	.SCREW, WITH WASHER	4	
20	646-14198-01-00	.GASKET	1	
21	6E7-14385-01-00	.FLOAT	1	
22	647-14386-10-00	.PIN, FLOAT	1	
23	6F5-14392-00-00	.VALVE, NEEDLE	1	
24	6E0-14227-00-00	.GASKET	1	
25	647-14323-00-00	.SCREW, AIR ADJUSTING	1	
26	6E0-24471-00-00	.DIAPHRAGM	1	
27	6E0-24411-00-00	.DIAPHRAGM	1	
28	6E0-W0001-C1-00	LOWER UNIT GASKET KIT	1	
29	93101-10M14-00	.OIL SEAL	2	
30	90430-08020-00	.GASKET	3	
31	6E0-45315-A0-00	.PACKING, LOWER CASING	1	
32	6E0-44315-A0-00	.GASKET, WATER PUMP	1	
33	93101-13M12-00	.OIL SEAL	2	
34	93210-48214-00	.O-RING	1	
35	6E0-W0078-A3-00	WATER PUMP REPAIR KIT	1	
36	6E0-44311-00-00	.HOUSING, WATER PUMP	1	
37	6E0-44315-A0-00	.GASKET, WATER PUMP	1	
38	6E0-44322-02-00	.INSERT, CARTRIDGE	1	
39	6E0-44323-00-00	.OUTER PLATE, CARTRIDGE	1	
40	6E0-44366-00-00	.DAMPER, WATER SEAL 2	1	
41	6E0-44352-00-00	.IMPELLER	1	
42	97095-06045-00	.BOLT	4	
43	93604-18080-00	.PIN, DOWEL	2	
44	6E0-W0078-0A-00	CHROME PUMP KIT	1	AP
45	6E0-44322-40-00	.INSERT, CARTRIDGE	1	CHROMATE
46	6E0-44323-40-00	.OUTER PLATE, CARTRIDGE	1	CHROMATE

Part Notes

5MSHW 1998 / REPAIR KIT

PART NUMBER	NOTE TEXT
90430-08020-00 	OEM: This part number is among the Top 100 Most Popular Marine Maintenance Parts as of March 2014.

©2014 Yamaha Motor Corporation, U.S.A. All rights reserved.

©2014 Yamaha Motor Corporation, U.S.A. All rights reserved.