

15ESHR 1993 / CYLINDER CRANKCASE

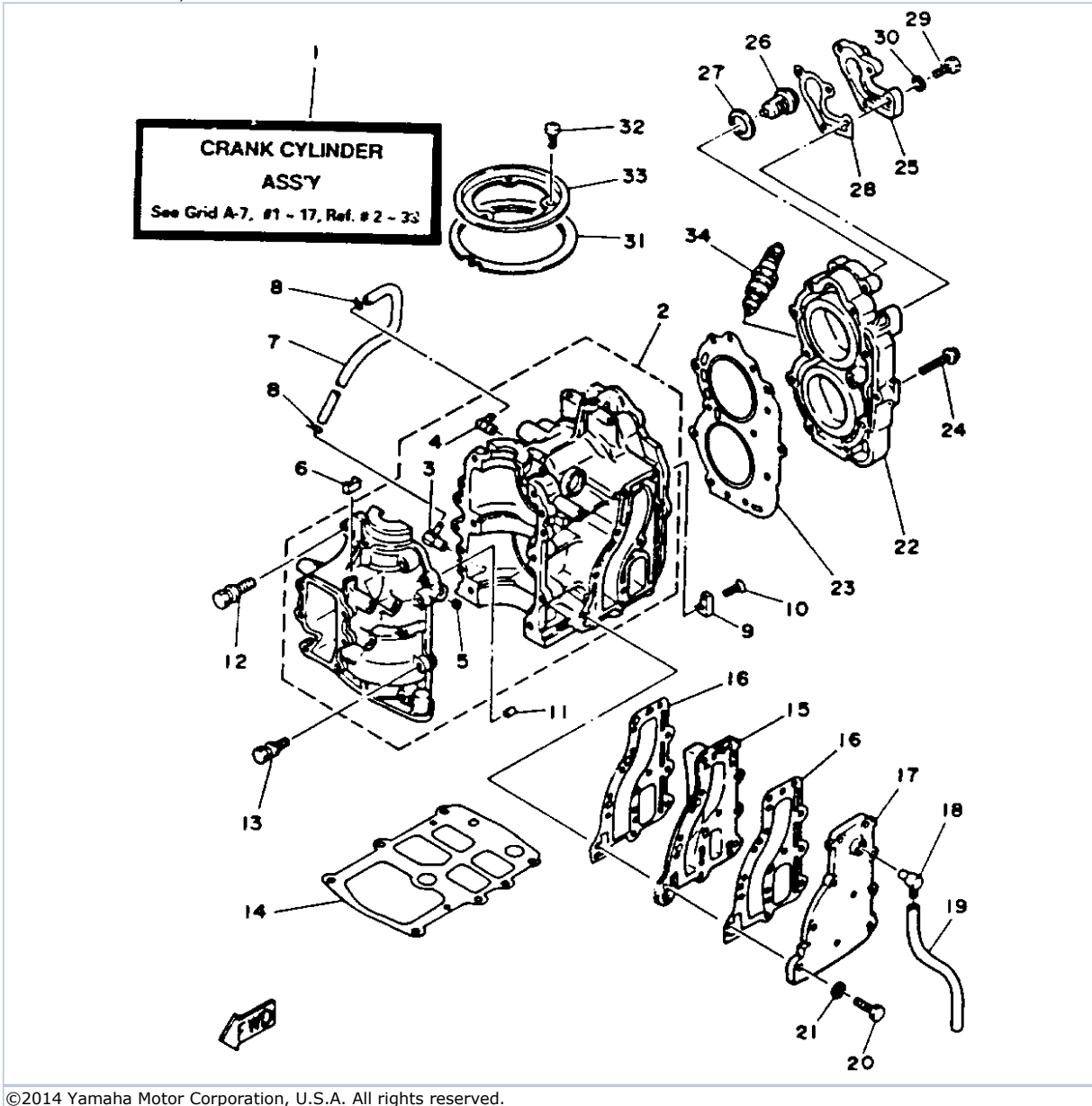

©2014 Yamaha Motor Corporation, U.S.A. All rights reserved.



## Part List

15ESHR 1993 / CYLINDER CRANKCASE

REF - NO	PART NUMBER	PART NAME	QUANTITY	REMARKS
1	6E7-W0090-03-EK	CRANK-CYLINDER.ASSEMBLY.	1	
2	6E7-15100-00-94	CRANKCASE ASSEMBLY	1	
3	650-11370-00-00	.CHECK VALVE ASSY	1	
4	650-14485-02-00	.PIPE, JOINT	1	
5	624-11379-00-00	.VALVE, CHECK	1	
6	682-41615-00-00	STOPPER, MAGNETO BASE	1	
7	90445-07M08-00	HOSE (L220)	1	
8	90467-06016-00	CLIP	2	
9	682-11325-00-00	ANODE	1	
10	98780-05016-00	.SCREW, FLAT HEAD	1	
11	93606-12019-00	.PIN, DOWEL	2	
12	90119-08M17-00	BOLT, WITH WASHER	6	
13	90119-06M13-00	BOLT, WITH WASHER	4	
14	682-11351-A0-00	GASKET, CYLINDER	1	
15	682-41111-00-9M	INNER COVER, EXHAUST	1	
16	682-41112-A1-00	GASKET, EXHAUST INNER COVER	2	
17	682-41113-00-9M	OUTER COVER, EXHAUST	1	
18	676-11372-00-00	.NIPPLE, HOSE	1	
19	90445-09095-00	HOSE (L215)	1	
20	97313-06025-00	BOLT	10	
21	92990-06600-00	WASHER, PLATE	10	
22	6E7-11111-00-94	HEAD, CYLINDER 1	1	
23	6E7-11181-A0-00	GASKET, CYLINDER HEAD 1	1	
24	90105-07M05-00	BOLT, FLANGE	11	
25	682-12413-00-9M	COVER, THERMOSTAT	1	
26	6F5-12411-02-00	THERMOSTAT	1	
27	90201-21567-00	WASHER, PLATE	1	
28	682-12414-A1-00	.GASKET, COVER	1	
29	97313-06020-00	BOLT, HEXAGON	4	
30	92990-06600-00	WASHER, PLATE	4	
31	682-41612-01-00	RETAINER, MAGNETO BASE	1	
32	98580-06010-00	SCREW, PAN HEAD	3	
33	682-41611-00-00	RETAINER, MAGNETO BASE	1	
34	NGK-B7HS1-00-00	PLUG, SPARK (NGK B7HS-10)	2	

## Part Notes

15ESHR 1993 / CYLINDER CRANKCASE

PART NUMBER	NOTE TEXT
92990-06600-00 	OEM: This part number is among the Top 100 Most Popular Marine Maintenance Parts as of March 2014.
92990-06600-00 	OEM: This part number is among the Top 100 Most Popular Marine Maintenance Parts as of March 2014.

©2014 Yamaha Motor Corporation, U.S.A. All rights reserved.

15ESHR 1993 / CRANKSHAFT PISTON

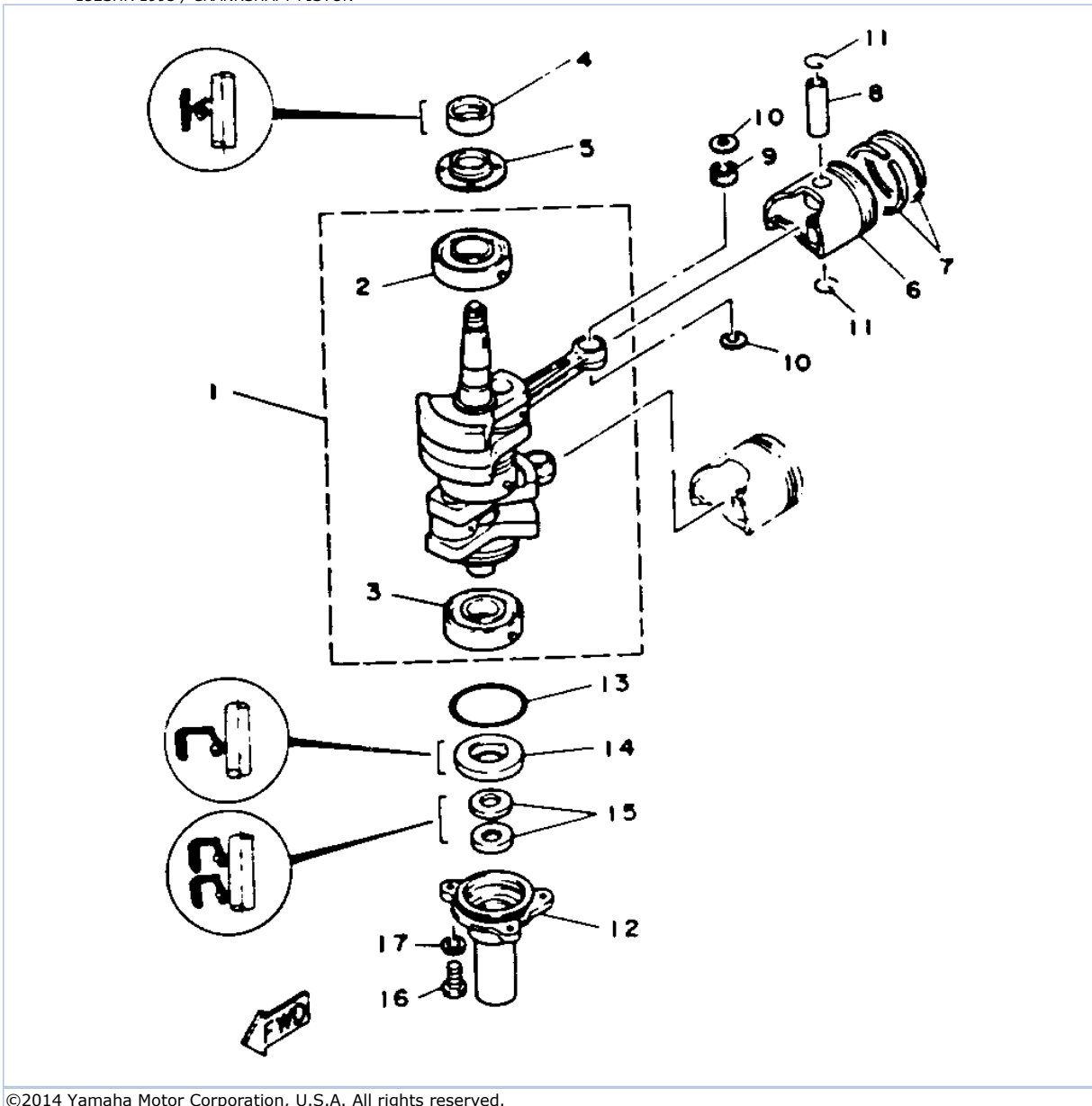

©2014 Yamaha Motor Corporation, U.S.A. All rights reserved.

## Part List

15ESHR 1993 / CRANKSHAFT PISTON

REF - NO	PART NUMBER	PART NAME	QUANTITY	REMARKS
1	682-11400-02-00	CRANKSHAFT ASSEMBLY	1	
2	93306-205U2-00	.BEARING	1	
3	93306-304U0-00	.BEARING	1	
4	93110-23M00-00	.OIL SEAL	1	
5	682-11445-00-00	SPACER	1	
6	6E7-11636-00-00	PISTON (0.50MM O/S)	2	AP
6	6E7-11631-00-97	PISTON (STD)	2	
7	682-11610-21-00	PISTON RING SET (0.50MM O/S)	2	AP
7	682-11610-01-00	PISTON RING SET (STD)	2	
8	634-11633-00-00	PIN, PISTON	2	
9	93602-14104-00	PIN, DOWEL	50	
10	90201-14377-00	WASHER, PLATE	4	
11	93450-15023-00	CIRCLIP	4	
12	682-15396-03-5B	HOUSING, OIL SEAL	1	
13	93210-53679-00	O-RING	1	
14	93101-20M29-00	OIL SEAL	1	
15	93101-13M11-00	OIL SEAL	2	
16	97395-06016-00	BOLT, HEX	3	
17	92990-06600-00	WASHER, PLATE	3	

## Part Notes

15ESHR 1993 / CRANKSHAFT PISTON

PART NUMBER	NOTE TEXT
92990-06600-00 	OEM: This part number is among the Top 100 Most Popular Marine Maintenance Parts as of March 2014.

©2014 Yamaha Motor Corporation, U.S.A. All rights reserved.

15ESHR 1993 / INTAKE

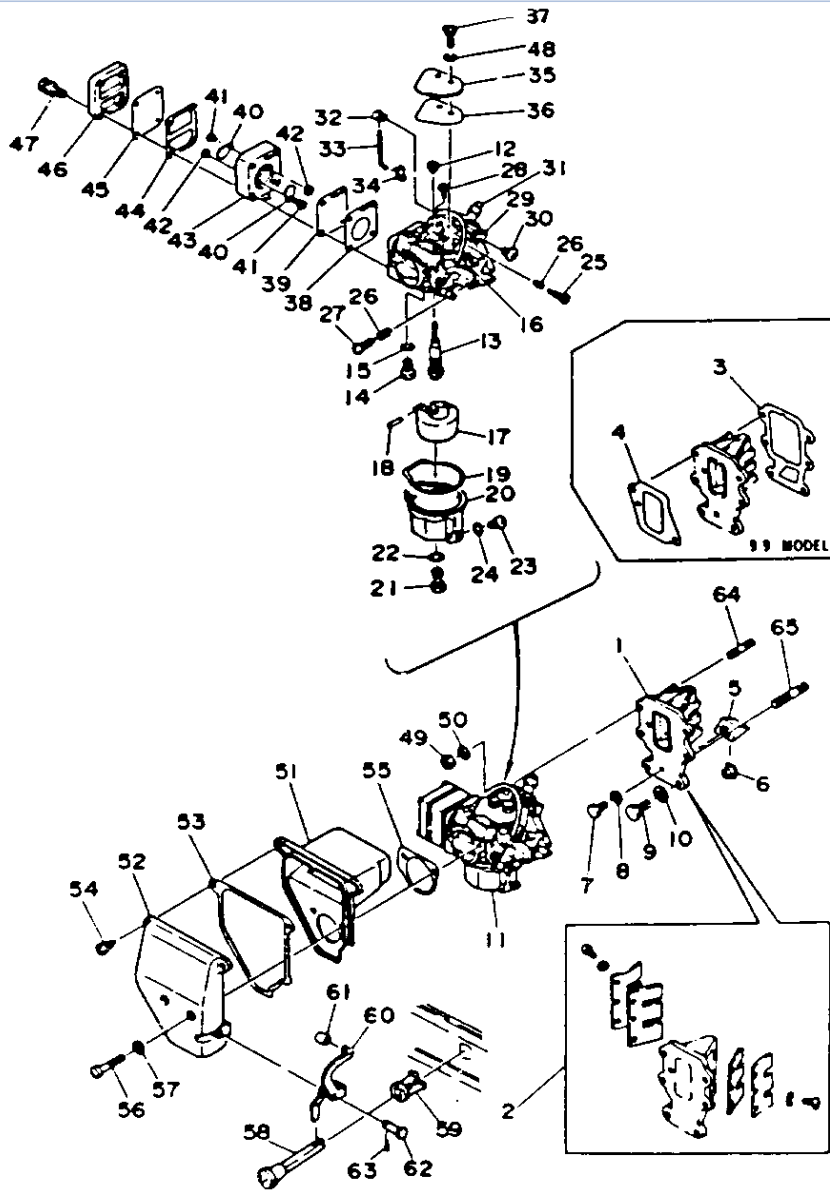

©2014 Yamaha Motor Corporation, U.S.A. All rights reserved.

## Part List



15ESHR 1993 / INTAKE

REF - NO	PART NUMBER	PART NAME	QUANTITY	REMARKS
1	6E7-13610-71-00	REED VALVE ASSEMBLY	1	UR 9.9
1	6E8-13610-01-00	REED VALVE ASSEMBLY	1	UR 15
2	6E7-W0004-70-00	.REED SET	1	UR 9.9
2	682-W0004-00-00	.REED SET	1	UR 15
3	682-13621-A0-00	GASKET, VALVE SEAT	1	9.9
4	677-14198-A0-00	GASKET	1	9.9
5	6E7-13625-00-00	SPACER, REED VALVE	1	
6	6E7-13588-01-00	NUT	1	
7	97013-06012-00	BOLT	1	
8	92990-06600-00	WASHER, PLATE	1	
9	97313-06016-00	BOLT, HEXAGON	4	
10	92990-06600-00	WASHER, PLATE	4	
11	6E7-14301-74-00	CARBURETOR ASSEMBLY 1	1	UR 9.9
11	6E8-14301-05-00	CARBURETOR ASSEMBLY 1	1	UR 15
12	6E7-14342-26-00	.JET, PILOT #52 (#52)	1	UR 9.9
12	6E7-14342-28-00	.JET, PILOT (# 56)	1	UR 15
13	6E7-14341-70-00	.NOZZLE, MAIN	1	UR 9.9
13	6E8-14341-00-00	.NOZZLE, MAIN	1	UR 15
14	6E8-14390-12-00	.NEEDLE VALVE ASSEMBLY	1	UR 9.9
14	61J-14390-00-00	.NEEDLE VALVE ASSEMBLY	1	UR 15
15	367-14195-00-00	.GASKET	1	
16	367-14396-00-00	.PIPE	1	
17	6E7-14385-00-00	.FLOAT	1	
18	647-14386-10-00	.PIN, FLOAT	1	
19	677-14384-01-00	.GASKET, FLOAT CHAMBER	1	
20	6E7-14381-00-00	.BODY, FLOAT CHAMBER	1	
21	677-14343-52-00	.JET, MAIN (#104)	1	UR 9.9
21	677-14343-68-00	.JET, MAIN (#136)	1	UR 15
22	1J2-14398-00-00	.GASKET	1	
23	97890-04005-00	.SCREW, PAN HEAD	1	
24	655-14398-00-00	.GASKET	1	
25	647-14323-00-00	.SCREW, AIR ADJUSTING	1	
26	646-14212-01-00	.SPRING, PILOT ADJUSTING	2	
27	664-14321-01-00	.SCREW, THROTTLE	1	
28	647-14326-00-00	.SCREW, GUIDE	1	
29	682-41210-00-00	.ACCEL ARM ASSEMBLY	1	
30	677-14327-01-00	.SCREW	1	
31	682-41291-00-00	.BUSHING	1	
32	677-41226-00-00	.END, THROTTLE LEVER	1	
33	682-41219-00-00	.ROD	1	
34	661-41262-02-00	.JOINT, CHOKE LEVER	1	
35	6E7-14157-00-00	.COVER, MIXING	1	
36	6E7-14227-00-00	.GASKET	1	
37	97980-04208-00	.SCREW, WITH WASHER	2	
38	677-24434-02-00	.GASKET, BODY	1	
39	677-24411-02-00	.DIAPHRAGM	1	
40	6A0-24421-01-00	.VALVE, CHECK	2	
41	6E7-14325-00-00	.SCREW, PAN HEAD	2	
42	95380-03600-00	.NUT	2	
43	682-24412-00-00	.BODY 1	1	
44	677-24435-02-00	.GASKET, BODY 2	1	
45	677-24471-01-00	.DIAPHRAGM	1	
46	677-24413-01-00	.BODY 2	1	
47	677-24444-01-00	.SCREW	4	
48	92901-04100-00	.WASHER, SPRING	2	
49	95380-06700-00	NUT	2	
50	92990-06600-00	WASHER, PLATE	2	
51	682-14417-02-00	COVER 1	1	
52	682-14418-01-00	COVER 2	1	
53	682-14416-A0-00	GASKET, AIR CLEANER	1	

54	97780-50514-00	SCREW, TAPPING	2	
55	682-14483-A0-00	GASKET	1	
56	98580-05530-00	SCREW, PAN HEAD	2	
57	92990-05600-00	WASHER, PLATE	2	
58	682-41271-00-00	KNOB, CHOKE	1	
59	682-41273-00-00	GROMMET	1	
60	682-41252-01-00	LEVER, CHOKE	1	
61	682-41267-00-00	BUSHING, JOINT	1	
62	682-41263-00-00	PIN, CHOKELEVER	1	
63	90468-10005-00	CLIP	1	
64	90116-06130-00	BOLT, STUD	1	
65	90116-06M04-00	BOLT, STUD	1	

## Part Notes

15ESHR 1993 / INTAKE

PART NUMBER		NOTE TEXT
92990-06600-00		OEM: This part number is among the Top 100 Most Popular Marine Maintenance Parts as of March 2014.
92990-06600-00		OEM: This part number is among the Top 100 Most Popular Marine Maintenance Parts as of March 2014.
92990-06600-00		OEM: This part number is among the Top 100 Most Popular Marine Maintenance Parts as of March 2014.

©2014 Yamaha Motor Corporation, U.S.A. All rights reserved.

15ESHR 1993 / MANUAL STARTER

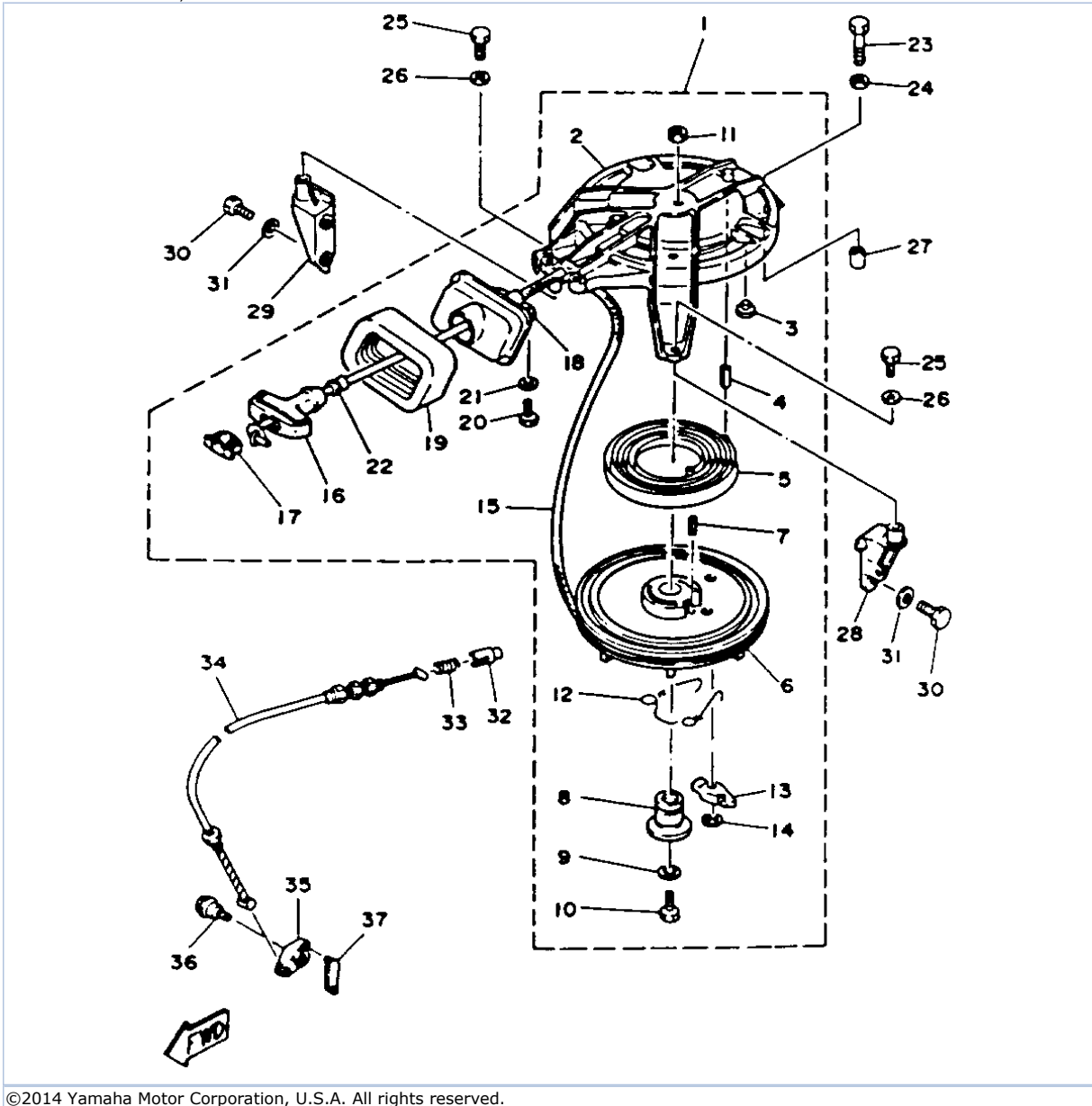

©2014 Yamaha Motor Corporation, U.S.A. All rights reserved.







## Part List

15ESHR 1993 / MANUAL STARTER

REF - NO	PART NUMBER	PART NAME	QUANTITY	REMARKS
1	6E7-15710-04-94	STARTER ASSEMBLY	1	
2	682-15711-71-94	.CASE, STARTER	1	
3	648-15773-00-00	.STAY 3	1	
4	91690-40016-00	.PIN, SPRING	1	
5	90510-08M04-00	.SPRING, SPIRAL	1	
6	677-15714-00-94	.DRUM, SHEAVE	1	
7	91690-40020-00	.PIN, SPRING	1	
8	677-15717-01-00	.SHAFT, STARTER	1	
9	90201-065F3-00	.WASHER, PLATE	1	
10	90119-06M34-00	.BOLT, WITH WASHER	1	
11	95380-06600-00	.NUT, HEXAGON	1	
12	677-15705-02-00	.SPRING, DRIVE PAWL	1	
13	677-15741-01-00	.PAWL, DRIVE	1	
14	93430-06M02-00	.CIRCLIP	1	
15	90890-44373-00	.ROPE, STARTER	1	
16	689-15755-01-00	.HANDLE, STARTER	1	
17	6F5-15779-02-00	.COVER	1	
18	6E7-15758-00-94	.GUIDE, ROPE	1	
19	6E7-15761-00-00	.SEAL, RUBBER 1	1	
20	97395-06016-00	.BOLT, HEX	2	
21	92990-06600-00	.WASHER, PLATE	2	
22	689-15789-00-00	.DAMPER	1	
23	97395-06035-00	BOLT, HEXAGON	1	
24	92990-06600-00	WASHER, PLATE	1	
25	97395-06020-00	BOLT, HEXAGON	2	
26	92990-06600-00	WASHER, PLATE	2	
27	99530-10014-00	PIN, DOWEL	1	
28	6E7-15771-01-94	STAY 1	1	
29	6E7-15771-80-94	STAY 1	1	
30	97313-06018-00	BOLT	4	
31	92990-06600-00	WASHER, PLATE	4	
32	656-15748-00-00	PLUNGER, STARTER STOP	1	
33	90501-10227-00	SPRING, COMPRESSION	1	
34	682-15770-00-00	CABLE COMP., STARTER STOP	1	
35	682-15746-00-00	ARM	1	
36	90109-06M04-00	BOLT	1	
37	682-15747-00-00	LINK	1	

## Part Notes

15ESHR 1993 / MANUAL STARTER

PART NUMBER		NOTE TEXT
92990-06600-00		OEM: This part number is among the Top 100 Most Popular Marine Maintenance Parts as of March 2014.
92990-06600-00		OEM: This part number is among the Top 100 Most Popular Marine Maintenance Parts as of March 2014.
92990-06600-00		OEM: This part number is among the Top 100 Most Popular Marine Maintenance Parts as of March 2014.
92990-06600-00		OEM: This part number is among the Top 100 Most Popular Marine Maintenance Parts as of March 2014.

©2014 Yamaha Motor Corporation, U.S.A. All rights reserved.

15ESHR 1993 / FUEL TANK

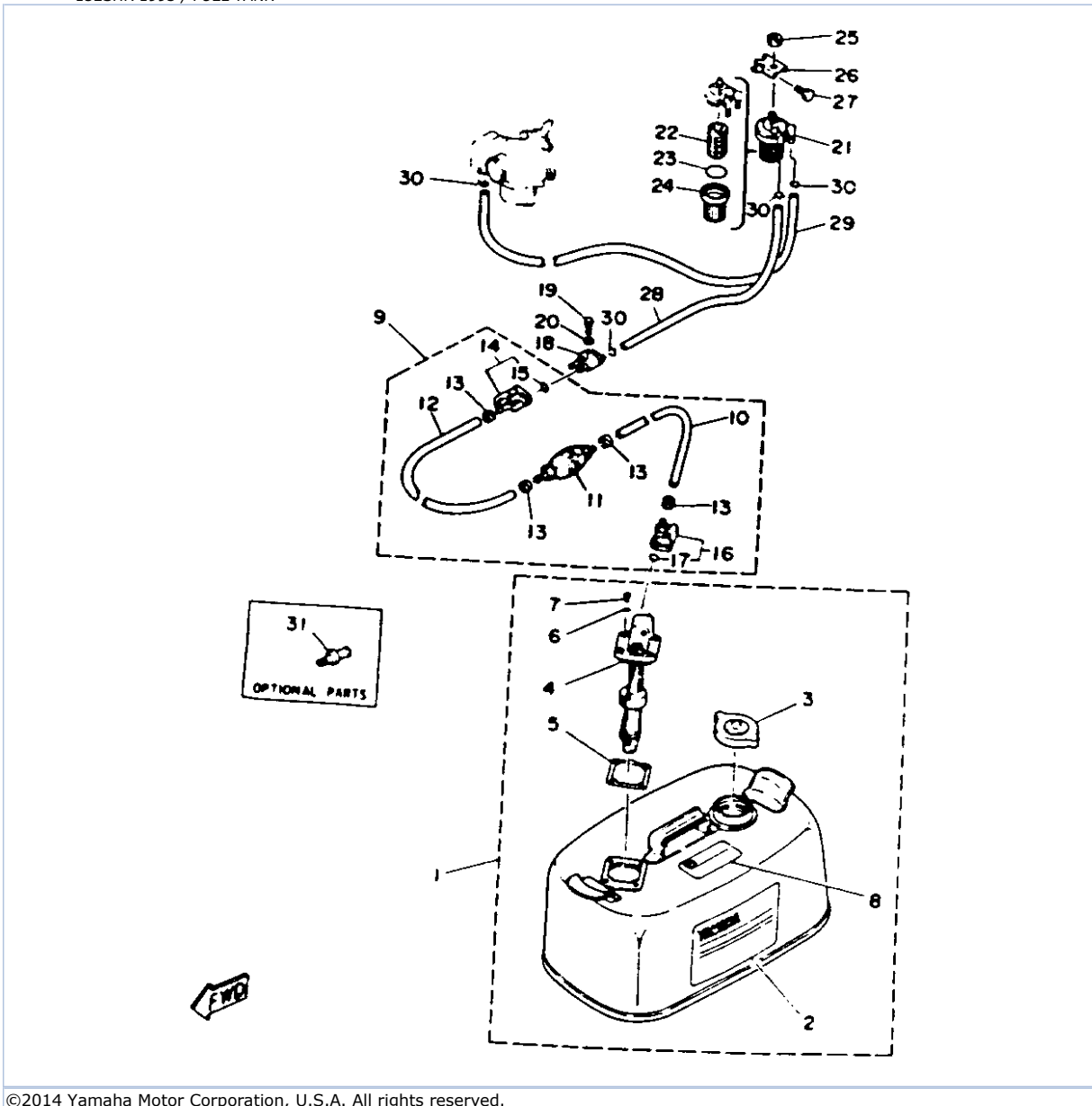

©2014 Yamaha Motor Corporation, U.S.A. All rights reserved.

## Part List

15ESHR 1993 / FUEL TANK

REF - NO	PART NUMBER	PART NAME	QUANTITY	REMARKS
1	6Y1-W2420-42-24	FUEL TANK ASSEMBLY	1	
2	6Y1-24244-20-00	.GRAPHIC, SIDE	1	
3	6Y1-24610-00-00	.CAP ASSEMBLY	1	
4	6Y1-24260-02-00	.FUEL METER ASSEMBLY	1	
5	6Y1-24268-00-00	.GASKET, FUEL METER	1	
6	6Y1-24329-00-00	.SEAL	4	
7	98586-05016-00	.SCREW, PAN HEAD	4	
8	6Y1-24255-40-00	.GRAPHIC, FUEL TNK 8	1	
9	6Y1-24306-51-00	FUEL PIPE COMP. 1	1	
10	90445-11M06-00	.HOSE (L2050)	1	
11	6Y1-24360-51-00	.PRIMER PUMP ASSY	1	
12	90445-11M05-00	.HOSE (L850)	1	
13	650-24351-51-00	.BAND 1	4	
14	6G1-24305-01-00	.FUEL PIPE JOINT COMP 2	1	
15	93210-08287-00	..O-RING	1	
16	6Y1-24305-02-00	.FUEL PIPE JOINT COMP 2	1	
17	93210-08287-00	..O-RING	1	
18	6G1-24304-02-00	FUEL PIPE JOINT COMP. 1	1	
19	97395-06020-00	BOLT, HEXAGON	1	
20	92990-06600-00	WASHER, PLATE	1	
21	655-24560-01-00	FILTER ASSEMBLY	1	
22	6F5-24563-00-00	.ELEMENT, FILTER	1	
23	93210-37M25-00	.O-RING	1	
24	655-24521-01-00	.CUP, FILTER	1	
25	95380-08600-00	NUT	1	
26	682-24566-00-00	BRACKET, FILTER	1	
27	97313-06010-00	BOLT, HEXAGON	1	
28	90445-09M53-00	HOSE	1	
29	90445-09100-00	HOSE (L260)	1	
30	90467-08004-00	CLIP	4	
31	ABB-FLUSH-JD-00	JET DRIVE FLUSH	1	AP

## Part Notes

15ESHR 1993 / FUEL TANK

PART NUMBER	NOTE TEXT
92990-06600-00 	OEM: This part number is among the Top 100 Most Popular Marine Maintenance Parts as of March 2014.

©2014 Yamaha Motor Corporation, U.S.A. All rights reserved.

15ESHR 1993 / TOP COWLING

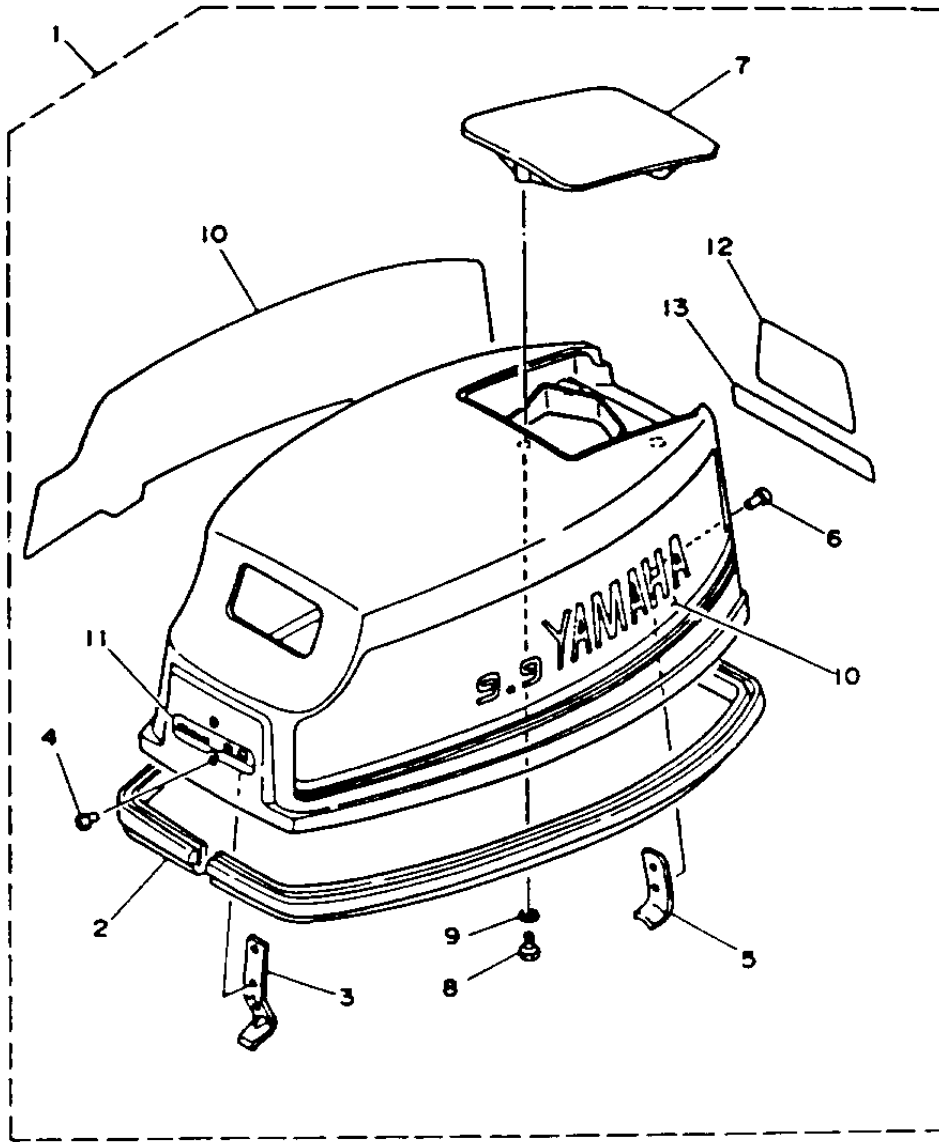

©2014 Yamaha Motor Corporation, U.S.A. All rights reserved.

## Part List

15ESHR 1993 / TOP COWLING

REF - NO	PART NUMBER	PART NAME	QUANTITY	REMARKS
1	6E7-42610-13-EK	TOP COWLING ASSEMBLY	1	UR 9.9
1	6E8-42610-13-EK	TOP COWLING ASSEMBLY	1	UR 15
2	682-42615-00-00	.SEAL	1	
3	6E7-42651-02-00	.HOOK	1	
4	90266-04M00-00	.RIVET	2	
5	6E7-42652-00-00	.HOOK	1	
6	90266-04M04-00	.RIVET	2	
7	6E7-42613-00-EK	.MOLDING, AIR DUCT	1	
8	97395-06016-00	.BOLT, HEX	3	
9	92990-06600-00	.WASHER, PLATE	3	
10	6E8-W0070-10-00	.GRAPHIC SET	1	UR 15
10	6E7-W0070-12-00	.GRAPHIC SET	1	UR 9.9
11	6E8-42677-10-00	.GRAPHIC, FRONT	1	UR 15
11	6E7-42677-10-00	.GRAPHIC, FRONT	1	UR 9.9
12	6E8-42678-11-00	.GRAPHIC, REAR	1	UR 15
12	6E7-42678-11-00	.GRAPHIC, REAR	1	UR 9.9
13	6E7-42682-10-00	MARK, COWLING 2	1	

## Part Notes

15ESHR 1993 / TOP COWLING

PART NUMBER	NOTE TEXT
92990-06600-00 	OEM: This part number is among the Top 100 Most Popular Marine Maintenance Parts as of March 2014.

©2014 Yamaha Motor Corporation, U.S.A. All rights reserved.

15ESHR 1993 / BOTTOM COWLING

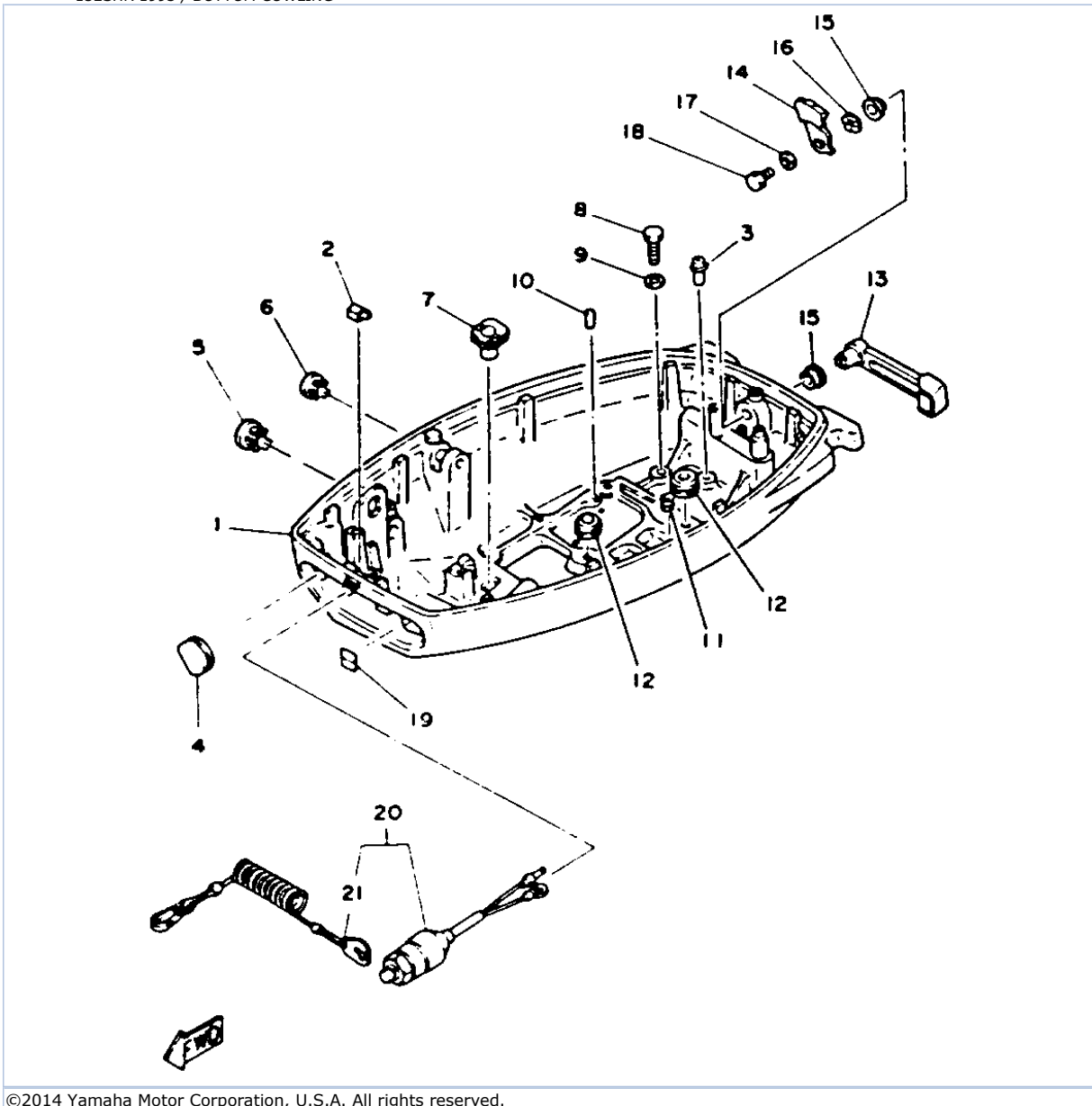

©2014 Yamaha Motor Corporation, U.S.A. All rights reserved.



## Part List

15ESHR 1993 / BOTTOM COWLING

REF - NO	PART NUMBER	PART NAME	QUANTITY	REMARKS
1	682-42711-03-EK	BOTTOM COWLING	1	
2	6K4-42629-00-00	SEAL	1	
3	652-24461-00-00	PIPE, JOINT 4	1	
4	682-42724-00-00	GROMMET	1	
5	682-42725-02-00	GROMMET	1	
6	682-42726-00-00	GROMMET	1	
7	682-42727-00-00	GROMMET	1	
8	97313-06020-00	BOLT, HEXAGON	2	
9	92990-06600-00	WASHER, PLATE	2	
10	93606-12019-00	.PIN, DOWEL	2	
11	682-44366-00-00	DAMPER, WATER SEAL	1	
12	682-44367-00-00	DAMPER, WATER SEAL	2	
13	682-42815-00-EK	LEVER, CLAMP 1	1	
14	6E7-42816-00-00	LEVER, CLAMP	1	
15	90386-12069-00	BUSH	2	
16	90206-12052-00	WASHER, WAVE	1	
17	90201-06M02-00	WASHER, PLATE	1	
18	97313-06010-00	BOLT, HEXAGON	1	
19	6A1-42792-01-00	MARK (100:1)	1	
20	6E9-82575-01-00	ENGINE STOP SWITCH ASSEMBLY	1	
21	682-82556-00-00	.LANYARD, STOP SWITCH	1	

## Part Notes

15ESHR 1993 / BOTTOM COWLING

PART NUMBER		NOTE TEXT
92990-06600-00		OEM: This part number is among the Top 100 Most Popular Marine Maintenance Parts as of March 2014.
682-82556-00-00		OEM: This part number is among the Top 100 Most Popular Marine Maintenance Parts as of March 2014.

©2014 Yamaha Motor Corporation, U.S.A. All rights reserved.

15ESHR 1993 / BRACKET

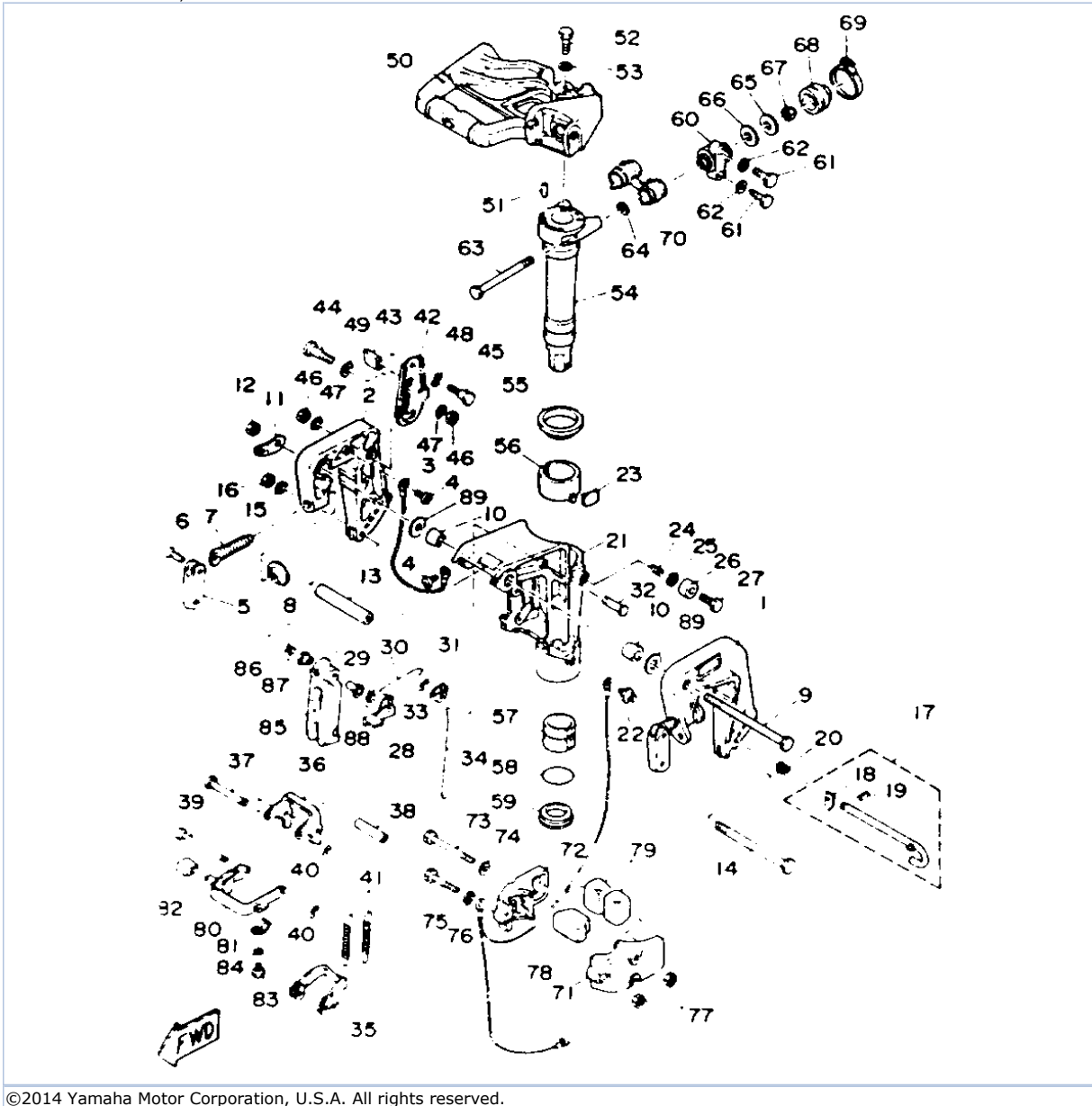



## Part List





15ESHR 1993 / BRACKET

REF - NO	PART NUMBER	PART NAME	QUANTITY	REMARKS
1	682-43111-03-EK	BRACKET, CLAMP	1	
2	682-43112-04-EK	BRACKET, CLAMP	1	
3	6E5-82148-00-00	WIRE, LEAD 4	1	
4	98580-06008-00	SCREW, PAN HEAD	2	
5	616-43118-00-EK	HANDLE, TRANSOM CLIP	2	
6	90243-04M00-00	PIN	2	
7	6E7-43116-00-00	SCREW, TRANSOM CLAMP	2	
8	648-43114-01-00	PAD, TRANSOM CLAMP	2	
9	90101-10M01-00	BOLT	1	
10	90386-10M91-00	BUSH	2	
11	6E7-43113-01-00	PLATE, CLAMP BRACKET	1	
12	95780-10300-00	NUT, FLANGE	1	
13	90387-06M13-00	COLLAR	1	
14	90101-06M29-00	BOLT	1	
15	92990-06600-00	WASHER, PLATE	1	
16	95380-06700-00	NUT	1	
17	689-43160-00-00	TILT ROD ASSY	1	
18	689-43165-00-00	.PLATE, TILT LOCK	1	
19	91690-30008-00	.PIN, SPRING	1	
20	90502-10M07-00	SPRING, CONICAL	1	
21	682-43311-05-EK	BRACKET, SWIVEL 1	1	
22	93700-06M03-00	NIPPLE, GREASE	1	
23	648-42528-00-00	PLATE, FRICTION	1	
24	90501-18M00-00	SPRING, COMPRESSION	1	
25	92990-08600-00	..WASHER, PLATE	1	
26	676-43373-00-00	SEAL, DAMPER	1	
27	97395-08025-00	BOLT	1	
28	682-43631-00-00	LEVER, TILT	1	
29	90508-12M03-00	SPRING, TORSION	1	
30	682-43616-00-00	ROD, TILT LOCK	1	
31	682-43641-00-00	LEVER, TILT	1	
32	90249-06M23-00	PIN	1	
33	99080-05600-00	CIRCLIP	1	
34	682-43617-00-00	ROD, TILT LOCK	1	
35	682-43614-00-00	PLATE, TILT LOCK	1	
36	682-43615-01-00	PLATE, TILT LOCK	1	
37	682-43611-01-00	SHAFT, TILT LOCK	1	
38	90387-06M20-00	COLLAR	1	
39	682-43659-00-00	SHAFT, REVERSE LOCK	1	
40	99080-05600-00	CIRCLIP	2	
41	90506-26M01-00	SPRING, TENSION	2	UR
41	90506-26M07-00	SPRING, TENSION	2	UR FOR DUAL THRUST
42	6E7-43181-01-00	LEVER, TILT STOP	1	
43	682-43318-01-00	COVER	1	
44	90109-06M03-00	BOLT	1	
45	90109-06M05-00	BOLT	1	
46	95680-06100-00	NUT, U	2	
47	92990-06600-00	WASHER, PLATE	2	
48	90206-10M15-00	WASHER, WAVE	1	
49	682-43339-01-00	WASHER	1	
50	6K4-42511-01-EK	BRACKET, STEERING	1	
51	93606-12019-00	.PIN, DOWEL	2	
52	97395-06025-00	BOLT	3	
53	92990-06600-00	WASHER, PLATE	3	
54	682-42521-00-94	SHAFT, STEERING PIVOT	1	
55	90209-52M01-00	WASHER	1	
56	682-42537-00-00	BUSHING, PIVOT SHAFT	1	
57	90386-40M09-00	BUSH	1	
58	93210-40M10-00	O-RING	1	
59	90386-40M08-00	BUSH	1	

60	682-44514-00-94	MOUNT DAMPER, UPPER SIDE	2	
61	97395-06025-00	BOLT	4	
62	92990-06600-00	WASHER, PLATE	4	
63	90101-08M30-00	BOLT	2	
64	90201-08M12-00	.WASHER, PLATE	2	
65	90201-08M13-00	WASHER, PLATE	2	
66	90202-13M02-00	WASHER, PLATE	2	
67	95780-08300-00	..NUT, FLANGE	2	
68	682-44522-00-00	SEAL	2	
69	90460-42M01-00	CLAMP, HOSE	2	
70	682-44521-01-00	SEAL	1	
71	682-44551-01-EK	HOUSING, LWR, MOUNTLOWER MOUNT	1	
72	682-44552-01-EK	HOUSING, LWR.MNT.LOWER MOUNT RUBBER	1	
73	97395-08085-00	BOLT	2	
74	92990-08600-00	..WASHER, PLATE	2	
75	97395-08055-00	BOLT	1	
76	92990-08600-00	..WASHER, PLATE	1	
77	95380-08700-00	NUT	3	
78	682-44557-00-00	MOUNT DAMPER, LOWER FRONT	1	
79	682-44555-00-00	MOUNT DAMPER, LOWER SIDE	2	
80	682-43681-01-00	LEVER, SHALLOW WATER DRIVE	1	
81	682-43643-00-00	SPRING	1	
82	682-43318-01-00	COVER	1	
83	97395-06008-00	BOLT, HEXAGON	1	
84	92990-06600-00	WASHER, PLATE	1	
85	682-42731-01-EK	CARRYING, HANDLE	1	
86	90508-16M04-00	SPRING, TORSION	1	
87	90386-10025-00	.BUSH	1	
88	90386-10045-00	BUSH	1	
89	90201-10M03-00	WASHER, PLATE	2	

## Part Notes

15ESHR 1993 / BRACKET

PART NUMBER		NOTE TEXT
92990-06600-00		OEM: This part number is among the Top 100 Most Popular Marine Maintenance Parts as of March 2014.
92990-06600-00		OEM: This part number is among the Top 100 Most Popular Marine Maintenance Parts as of March 2014.
92990-06600-00		OEM: This part number is among the Top 100 Most Popular Marine Maintenance Parts as of March 2014.
92990-06600-00		OEM: This part number is among the Top 100 Most Popular Marine Maintenance Parts as of March 2014.
92990-06600-00		OEM: This part number is among the Top 100 Most Popular Marine Maintenance Parts as of March 2014.

©2014 Yamaha Motor Corporation, U.S.A. All rights reserved.

15ESHR 1993 / CONTROL ENGINE

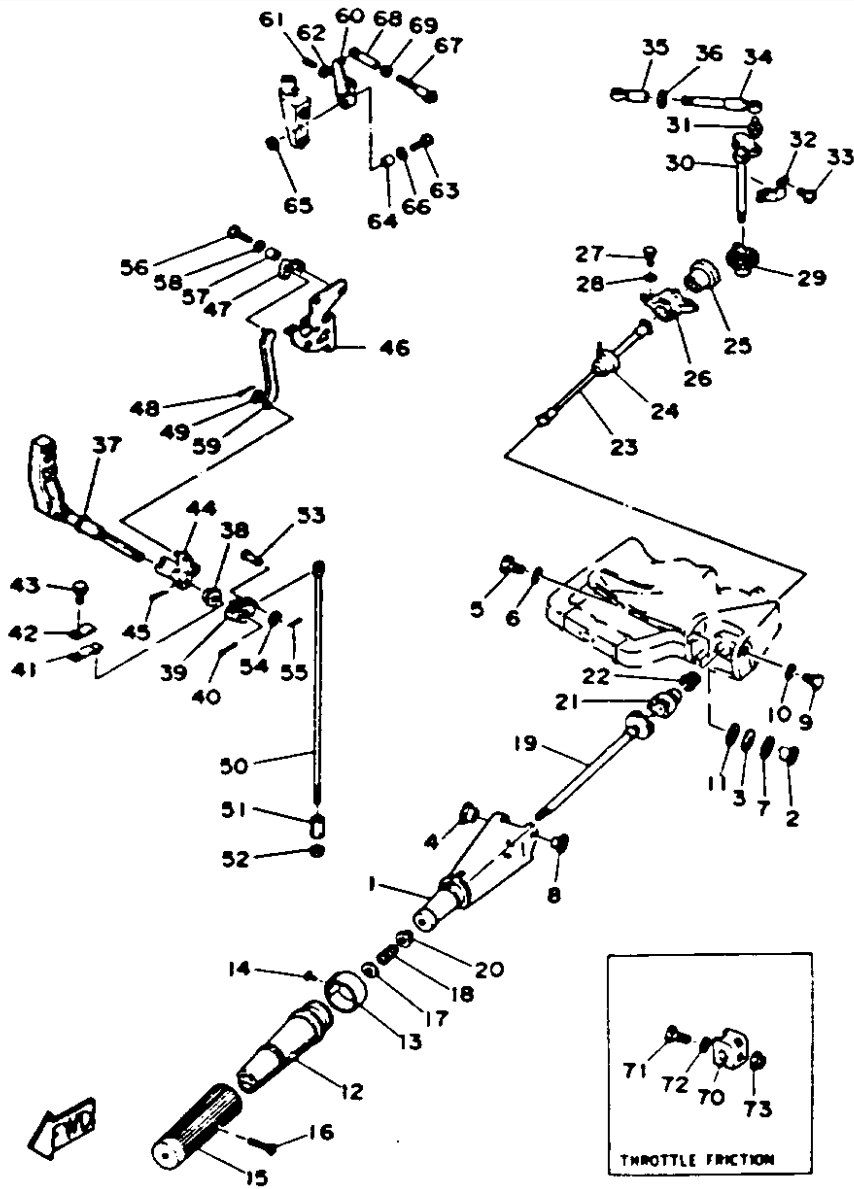

©2014 Yamaha Motor Corporation, U.S.A. All rights reserved.

## Part List



15ESHR 1993 / CONTROL ENGINE

REF - NO	PART NUMBER	PART NAME	QUANTITY	REMARKS
1	6E7-42111-00-EK	HANDLE, STEERING	1	
2	682-42123-02-00	BOLT, HANDLE JOINT	1	
3	90206-12M06-00	WASHER, WAVE	1	
4	90386-12M07-00	BUSH	1	
5	97395-06025-00	BOLT	1	
6	92990-06600-00	WASHER, PLATE	1	
7	90201-12181-00	WASHER, PLATE	1	
8	90386-06M06-00	BUSH	1	
9	90109-08M01-00	BOLT	1	
10	92990-08600-00	..WASHER, PLATE	1	
11	90202-12031-00	WASHER, PLATE	1	
12	664-42119-00-00	GRIP, STEERING HANDLE	1	
13	6E8-42137-10-00	INDICATOR, THROTTLE	1	
14	90269-02M09-00	RIVET	1	
15	6G1-42177-00-00	RUBBER, HANDLE	1	
16	90149-05M13-00	SCREW	1	
17	92990-10600-00	WASHER, PLATE	1	
18	90501-23215-00	SPRING, COMPRESSION	1	
19	6E7-42141-00-94	GEAR, KNEE 1	1	
20	90386-08032-00	BUSH	1	
21	682-42142-01-00	GEAR, KNEE 2	1	
22	90386-20M71-00	BUSH	1	
23	682-42116-00-00	SHAFT, STEERING HANDLE 2	1	
24	682-42716-00-00	RUBBER, SEAL 1	1	
25	682-42151-01-00	PINION	1	
26	682-42171-02-00	BUSHING	1	
27	97313-06016-00	BOLT, HEXAGON	2	
28	92990-06200-00	WASHER, PLAIN	2	
29	682-42152-01-00	GEAR	1	
30	682-41631-00-94	LEVER, MAGNETO CONTROL	1	
31	663-85518-00-00	JOINT, BALL	1	
32	682-41661-00-00	BRACKET	1	
33	97890-06010-00	SCREW, PAN HEAD	2	
34	682-41238-01-00	JOINT, LINK	1	
35	682-41237-00-00	JOINT, LINK	1	
36	95380-05700-00	NUT	1	
37	682-44111-01-94	HANDLE, GEAR SHIFT	1	
38	682-44132-00-00	BUSHING	1	
39	682-44121-00-00	LEVER, SHIFT ROD	1	
40	91490-25020-00	PIN. COTTER	1	
41	682-44116-00-00	SPRING	1	
42	682-44117-00-00	BRACKET	1	
43	97395-06012-00	BOLT	1	
44	682-44125-01-00	LEVER, SHIFT ROD	1	
45	91490-25020-00	PIN. COTTER	1	
46	682-44118-70-00	BRACKET	1	
47	682-41666-70-00	STOPPER, MAGNETO CONTROL LEVER	1	
48	91490-20015-00	PIN. COTTER	1	
49	92990-05600-00	WASHER, PLATE	1	
50	682-44143-00-00	ROD, SHIFT	1	
51	90170-06015-00	NUT	1	
52	95380-06700-00	NUT	1	
53	91790-05020-00	PIN, CLEVIS	1	
54	92990-05600-00	WASHER, PLATE	1	
55	91490-16010-00	PIN. COTTER	1	
56	97395-06020-00	BOLT, HEXAGON	1	
57	90387-06M02-00	COLLAR	1	
58	90201-06M31-00	.WASHER, PLATE	1	
59	682-44124-70-00	LINK, SHIFT ROD	1	

60	682-41634-70-00	LEVER, MAGNETO CONTROL 4	1	
61	90113-05M05-00	BOLT, SET	1	
62	95380-05700-00	NUT	1	
63	97395-06020-00	BOLT, HEXAGON	1	
64	90387-06M02-00	COLLAR	1	
65	95380-06700-00	NUT	1	
66	90201-06M31-00	.WASHER, PLATE	1	
67	682-41237-50-00	JOINT, LINK	1	
68	682-41237-00-00	JOINT, LINK	1	
69	95380-05700-00	NUT	1	
70	656-42126-01-00	FRICITION, STEERING HANDLE GRIP	1	
71	97395-06020-00	BOLT, HEXAGON	1	
72	92990-06600-00	WASHER, PLATE	1	
73	90185-06062-00	NUT, SELF-LOCKING	1	

## Part Notes

15ESHR 1993 / CONTROL ENGINE

PART NUMBER		NOTE TEXT
92990-06600-00		OEM: This part number is among the Top 100 Most Popular Marine Maintenance Parts as of March 2014.
92990-10600-00		OEM: This part number is among the Top 100 Most Popular Marine Maintenance Parts as of March 2014.
92990-06600-00		OEM: This part number is among the Top 100 Most Popular Marine Maintenance Parts as of March 2014.

©2014 Yamaha Motor Corporation, U.S.A. All rights reserved.

15ESHR 1993 / UPPER CASING

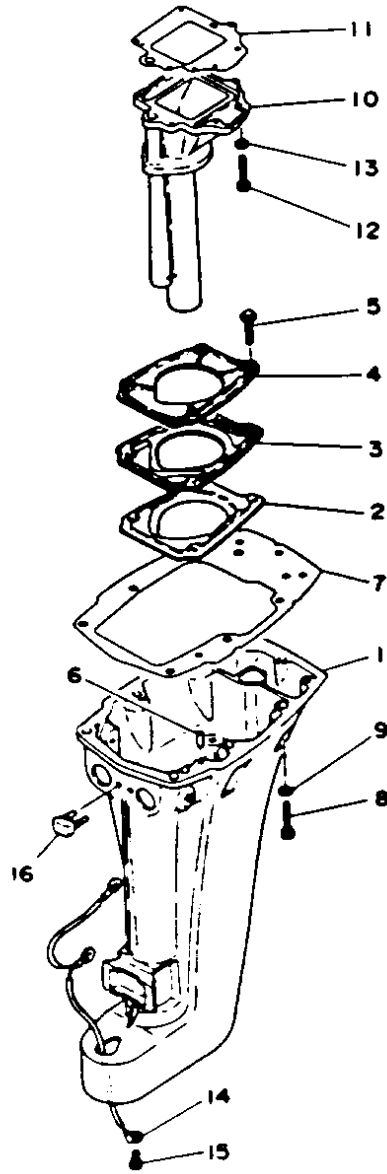

©2014 Yamaha Motor Corporation, U.S.A. All rights reserved.

## Part List

15ESHR 1993 / UPPER CASING

REF - NO	PART NUMBER	PART NAME	QUANTITY	REMARKS
1	682-45111-04-EK	CASING, UPPER	1	UR SHORT
1	682-45111-14-EK	CASING, UPPER	1	UR LONG
2	682-45126-00-5B	PLATE, SEAL DAMPER	1	
3	682-45127-00-00	SEAL	1	
4	682-41116-00-5B	PROTECTOR	1	
5	90105-06M01-00	BOLT, WASHER BASED	4	
6	93606-12019-00	.PIN, DOWEL	2	
7	682-45113-A1-00	GASKET, UPPER CASING	1	
8	97395-08040-00	BOLT	6	
9	92990-08600-00	..WASHER, PLATE	6	
10	682-41131-01-5B	MANIFOLD, EXT. 1	1	
11	682-41133-A0-00	GASKET, EXHAUST MANIFOLD 1	1	
12	97395-06020-00	BOLT, HEXAGON	6	
13	92990-06600-00	WASHER, PLATE	6	
14	6E7-82127-00-00	WIRE, LEAD 2	1	
15	90157-06M06-00	SCREW, PAN HEAD	1	
16	682-44532-00-00	STOPPER, UPPER MOUNT	1	

## Part Notes

15ESHR 1993 / UPPER CASING

PART NUMBER	NOTE TEXT
92990-06600-00 	OEM: This part number is among the Top 100 Most Popular Marine Maintenance Parts as of March 2014.

©2014 Yamaha Motor Corporation, U.S.A. All rights reserved.

15ESHR 1993 / LOWER DRIVE 1

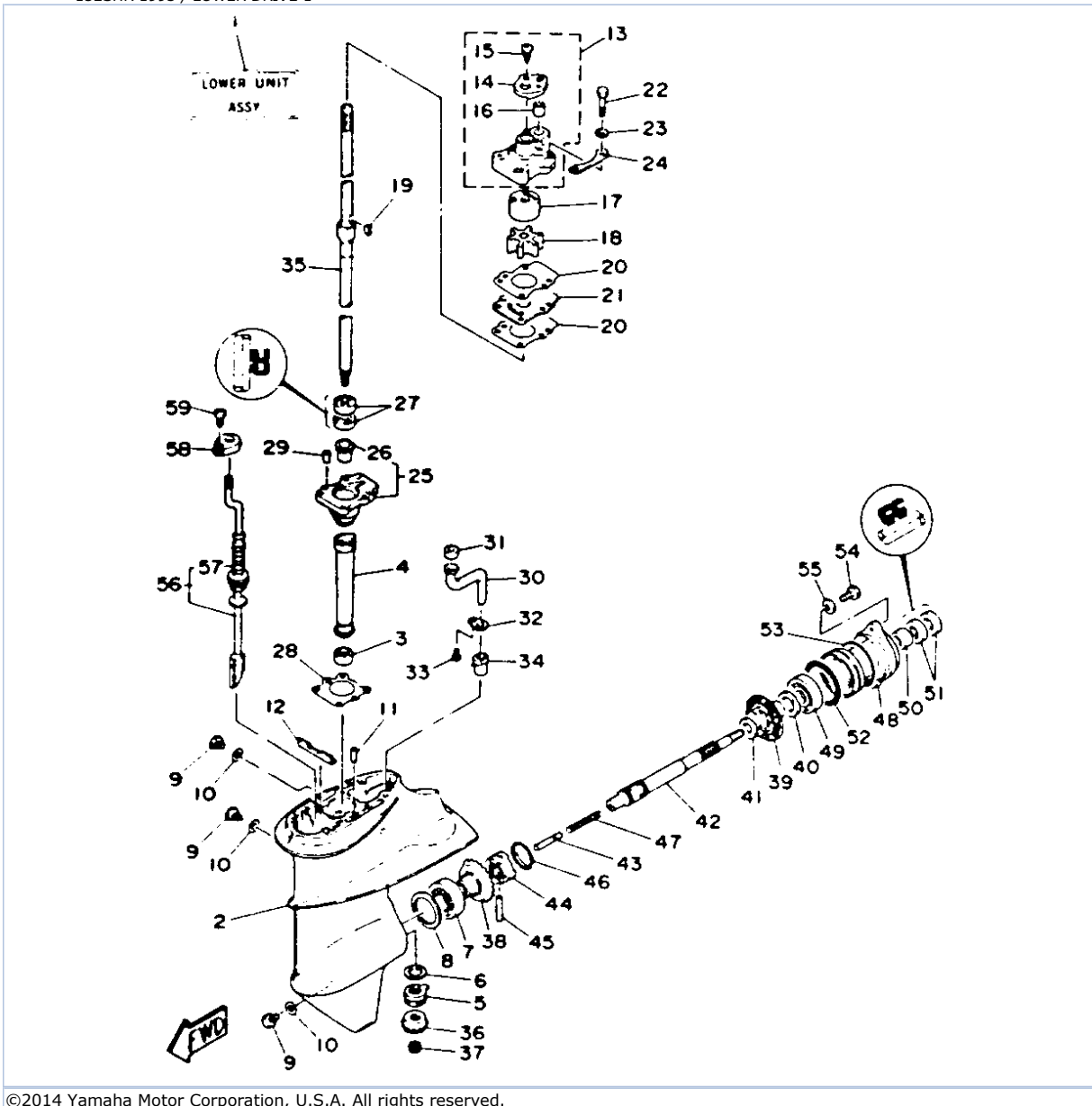

©2014 Yamaha Motor Corporation, U.S.A. All rights reserved.



## Part List



15ESHR 1993 / LOWER DRIVE 1

REF - NO	PART NUMBER	PART NAME	QUANTITY	REMARKS
1	6E7-45300-16-EK	LOWER UNIT ASSEMBLY	1	UR LONG
1	6E7-45300-06-EK	LOWER UNIT ASSEMBLY	1	UR SHORT
2	6E8-45311-00-EK	CASING, LOWER	1	
3	93315-314V8-00	BEARING	1	
4	6E7-45536-00-00	SLEEVE, DRIVE SHAFT	1	
5	93341-414V1-00	BEARING	1	
6	6E8-45587-00-13	SHIM (T:1.13MM)	1	UR
6	6E8-45587-00-20	SHIM (T:1.20MM)	1	UR
7	93332-00005-00	BEARING	1	
8	664-45567-01-12	SHIM (T:0.12MM)	1	UR
8	664-45567-01-30	SHIM (T:0.30MM)	1	UR
8	664-45567-01-50	SHIM (T:0.50MM)	1	UR
8	664-45567-01-10	SHIM (T:0.10MM)	1	UR
8	664-45567-01-15	SHIM (T:0.15MM)	1	UR
8	664-45567-01-18	SHIM (T:0.18MM)	1	UR
8	664-45567-01-40	SHIM (T:0.40MM)	1	UR
9	90340-08M04-00	PLUG, STRAIGHT SCREW	3	
10	90430-08020-00	.GASKET	3	
11	93604-08062-00	PIN, DOWEL	1	
12	682-45376-01-00	GUIDE, SEAL DAMPER	1	
13	682-44300-01-00	HOUSING, WATER PUMP	1	
14	682-44312-00-00	.COVER, WATER PUMP HOUSING	1	
15	97780-40112-00	.SCREW, TAPPING	2	
16	682-44365-00-00	.DAMPER, WATER SEAL	1	
17	682-44322-00-00	INSERT, CARTRIDGE	1	
18	682-44352-01-00	IMPELLER	1	
19	90280-03024-00	.KEY, WOODRUFF	1	
20	682-44315-A0-00	GASKET, WATER PUMP	2	
21	682-44323-00-00	OUTER PLATE, CARTRIDGE	1	
22	97395-06040-00	BOLT	4	
23	92990-06600-00	WASHER, PLATE	4	
24	682-44328-00-00	PLATE	2	
25	6E7-45331-00-5B	HOUSING, BEARING	1	
26	626-45316-09-00	.BUSHING, DRIVE SHAFT	1	
27	93101-20048-00	.OIL SEAL	2	
28	683-45315-A0-00	PACKING, LOWER CASING	1	
29	93606-12019-00	.PIN, DOWEL	2	
30	683-44362-01-00	TUBE, WATER	1	
31	683-44365-01-00	DAMPER, WATER SEAL	1	
32	683-44373-00-00	SET PLATE, WATER TUBE	1	
33	97395-06010-00	BOLT	1	
34	6E7-44366-00-00	DAMPER, WATER SEAL	1	
35	6E7-45501-00-00	DRIVE SHAFT COMP.	1	UR SHORT
35	6E7-45501-10-00	DRIVE SHAFT COMP.	1	UR LONG
36	6E7-45551-00-00	PINION (13T)	1	
37	90179-08M06-00	NUT	1	
38	6E7-45560-00-00	GEAR	1	
39	6E7-45571-00-00	GEAR 2 (27T)	1	
40	626-45577-00-01	SHIM (T:0.10MM)	1	UR
40	626-45577-00-03	SHIM (T:0.30MM)	1	UR
40	626-45577-00-05	SHIM (T:0.50MM)	1	UR
41	90201-17682-00	WASHER, PLATE	1	
42	683-45611-00-00	SHAFT, PROPELLER	1	
43	650-45635-00-00	PLUNGER, SHIFT	1	
44	682-45631-00-00	CLUTCH, DOG	1	
45	90250-05010-00	PIN, STRAIGHT	1	
46	648-45633-00-00	RING, CROSS PIN	1	
47	90501-14M06-00	SPRING, COMPRESSION	1	
48	683-45361-01-EK	CAP, LOWER CASING	1	

49	93306-00501-00	BEARING	1	
50	93315-317U2-00	BEARING	1	
51	93101-17054-00	.OIL SEAL	2	
52	93210-57M09-00	.O-RING	1	
53	93210-56M80-00	.O-RING	1	
54	97395-06020-00	BOLT, HEXAGON	2	
55	92990-06600-00	WASHER, PLATE	2	
56	682-44150-00-00	SHIFT CAM ASSEMBLY	1	UR SHORT
56	682-44150-10-00	SHIFT CAM ASSEMBLY	1	UR LONG
57	682-44147-00-00	.BOOT, SHIFT ROD	1	
58	682-44176-00-00	BRACKET	1	
59	97780-50110-00	SCREW, PAN HEAD	1	

## Part Notes

15ESHR 1993 / LOWER DRIVE 1

PART NUMBER		NOTE TEXT
90430-08020-00		OEM: This part number is among the Top 100 Most Popular Marine Maintenance Parts as of March 2014.
92990-06600-00		OEM: This part number is among the Top 100 Most Popular Marine Maintenance Parts as of March 2014.
92990-06600-00		OEM: This part number is among the Top 100 Most Popular Marine Maintenance Parts as of March 2014.

©2014 Yamaha Motor Corporation, U.S.A. All rights reserved.

15ESHR 1993 / LOWER DRIVE 2

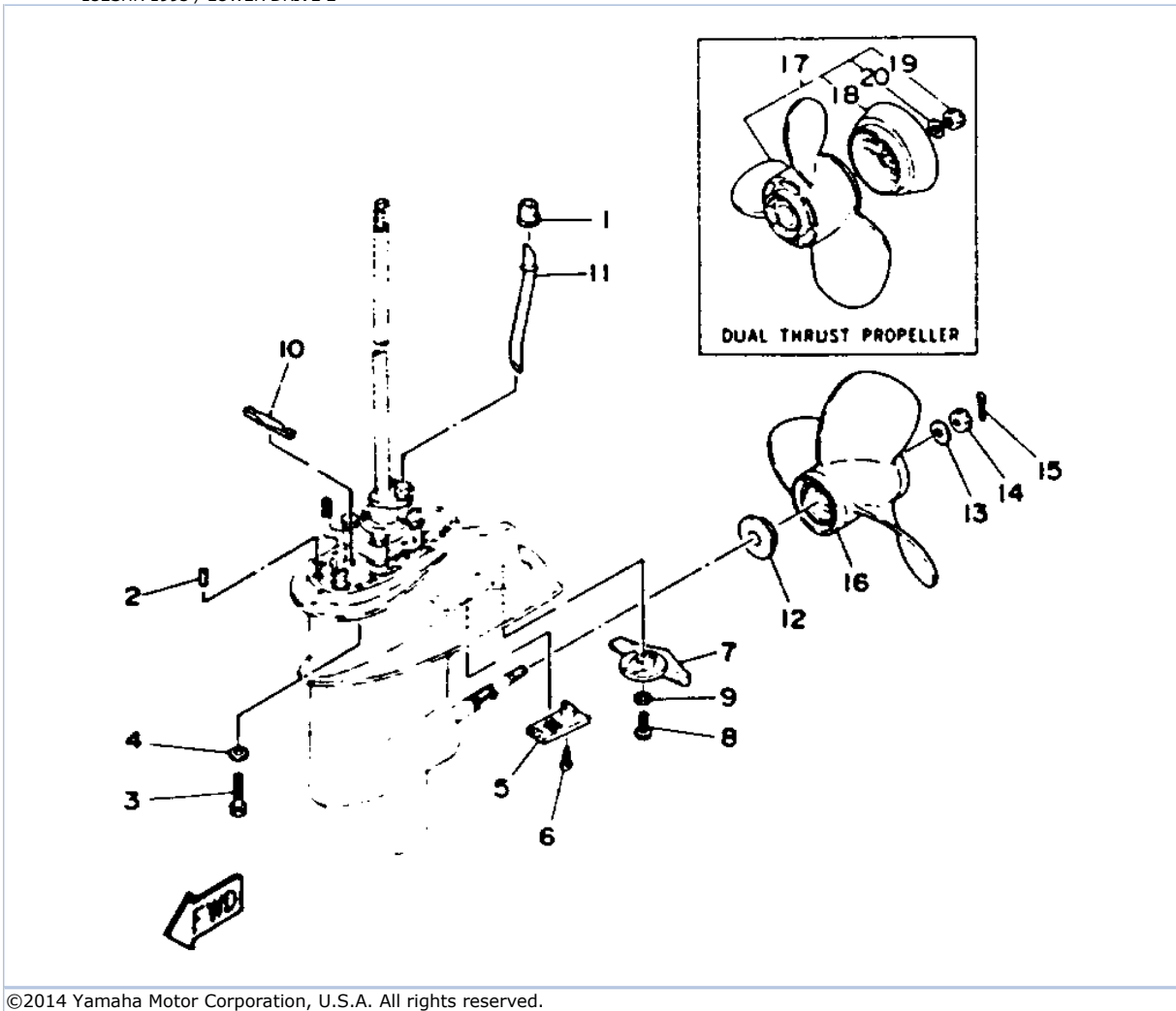

©2014 Yamaha Motor Corporation, U.S.A. All rights reserved.

## Part List

15ESHR 1993 / LOWER DRIVE 2

REF - NO	PART NUMBER	PART NAME	QUANTITY	REMARKS
1	626-44365-01-00	DAMPER, WATER SEAL	1	
2	93606-12019-00	.PIN, DOWEL	2	
3	97090-08035-00	BOLT	4	
4	92990-08600-00	..WASHER, PLATE	4	
5	6E7-45214-00-00	COVER, WATER INLET 1	1	
6	98580-05012-00	.SCREW, PAN HEAD	1	
7	6E8-45251-01-00	ANODE	1	
8	97395-06020-00	BOLT, HEXAGON	1	
9	92990-06600-00	WASHER, PLATE	1	
10	682-45375-01-00	DAMPER, SEAL	1	
11	682-44361-00-00	TUBE, WATER	1	UR SHORT
11	682-44361-10-00	TUBE, WATER	1	UR LONG
12	6E7-45987-01-00	SPACER 1	1	
13	90201-10M01-00	WASHER, PLATE	1	
14	90171-10M01-00	NUT, CASTLE	1	
15	91490-30020-00	PIN, COTTER	1	UR
15	91490-30030-00	PIN, COTTER	1	UR FOR DUAL THRUST PROP.
16	683-45952-00-EL	PROPELLER (3X9-1/4"X9-3/4"-J)	1	UR
16	683-45947-00-EL	PROPELLER (3X9-1/4"X8"-J)	1	UR
16	683-45945-00-EL	PROPELLER (3X9-1/4"X9"-J)	1	UR
16	683-45943-00-EL	PROPELLER (3X9-1/4"X10-1/2"-J)	1	UR
17	683-W4592-02-EL	PROPELLER (3X9-3/4"X6-1/2"-J)	1	UR
17	683-W4591-02-EL	PROPELLER (3X9-3/4"X8"-J)	1	UR
18	6E7-45986-00-00	.RING, DEFLECTOR	1	
19	90171-10M07-00	.NUT, CASTLE	1	
20	90201-10M02-00	.WASHER, PLATE	1	

## Part Notes

15ESHR 1993 / LOWER DRIVE 2

PART NUMBER	NOTE TEXT
92990-06600-00 	OEM: This part number is among the Top 100 Most Popular Marine Maintenance Parts as of March 2014.

©2014 Yamaha Motor Corporation, U.S.A. All rights reserved.

15ESHR 1993 / CDI MAGNETO

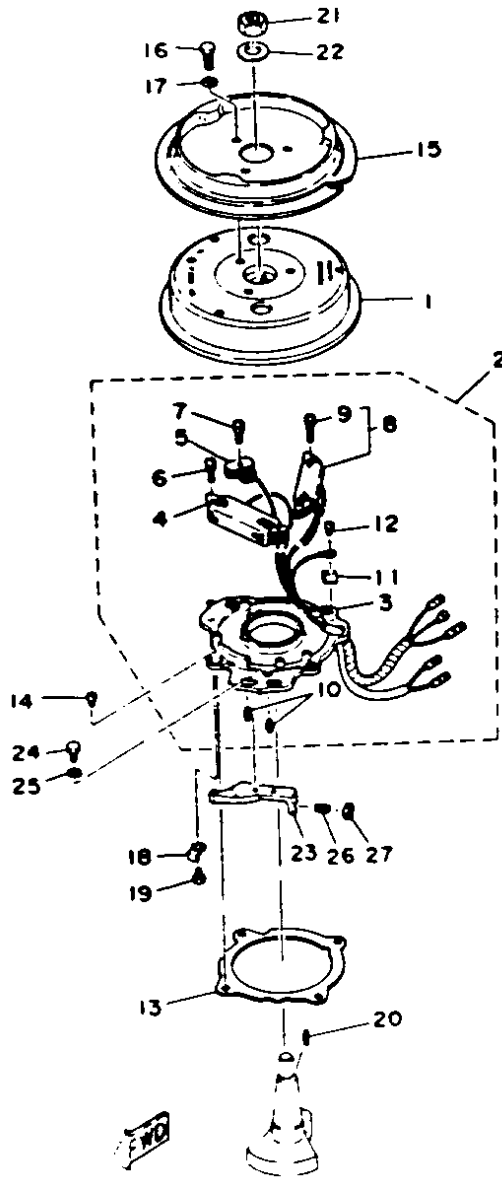

©2014 Yamaha Motor Corporation, U.S.A. All rights reserved.

## Part List

15ESHR 1993 / CDI MAGNETO

REF - NO	PART NUMBER	PART NAME	QUANTITY	REMARKS
1	6E7-85550-70-00	ROTOR ASSEMBLY	1	
2	6E7-85560-A0-00	BASE ASSY	1	
3	6E7-85509-70-00	.BASE, MAGNETO	1	
4	6E7-85520-70-00	.COIL, CHARGE	1	
5	6E7-85580-70-00	.COIL, PULSER	1	
6	90159-05039-00	.SCREW, W/WASHER	2	
7	90159-05038-00	.SCREW, WITH WASHER	1	
8	6E7-81303-A0-00	.LIGHTING COIL ASSY	1	
9	90159-05039-00	..SCREW, W/WASHER	2	
10	663-85518-00-00	.JOINT, BALL	2	
11	6E7-81328-70-00	.CLAMP, CORD	1	
12	98511-04006-00	.SCREW, PAN HEAD (98502-04006)	1	
13	682-41613-02-00	PLATE, BASE FRICTION	1	
14	97890-05008-00	SCREW, PAN HEAD	5	
15	6E7-15723-00-94	PULLEY, STARTER	1	
16	97013-06012-00	BOLT	3	
17	92990-06600-00	WASHER, PLATE	3	
18	682-41616-00-00	STOPPER, MAGNETO BASE	1	
19	97390-05010-00	BOLT, HEXAGON	1	
20	90280-16053-00	KEY, WOODRUFF	1	
21	90170-12066-00	NUT	1	
22	90201-12472-00	WASHER, PLATE	1	
23	6E8-41213-00-94	CAM, ACCEL.	1	
24	97395-05010-00	BOLT	2	
25	92990-05600-00	WASHER, PLATE	2	
26	90113-05M04-00	BOLT, SET	1	
27	95380-05700-00	NUT	1	

## Part Notes

15ESHR 1993 / CDI MAGNETO

PART NUMBER	NOTE TEXT
92990-06600-00 	OEM: This part number is among the Top 100 Most Popular Marine Maintenance Parts as of March 2014.

©2014 Yamaha Motor Corporation, U.S.A. All rights reserved.

15ESHR 1993 / CDI MAGNETO (9.9E 15E)

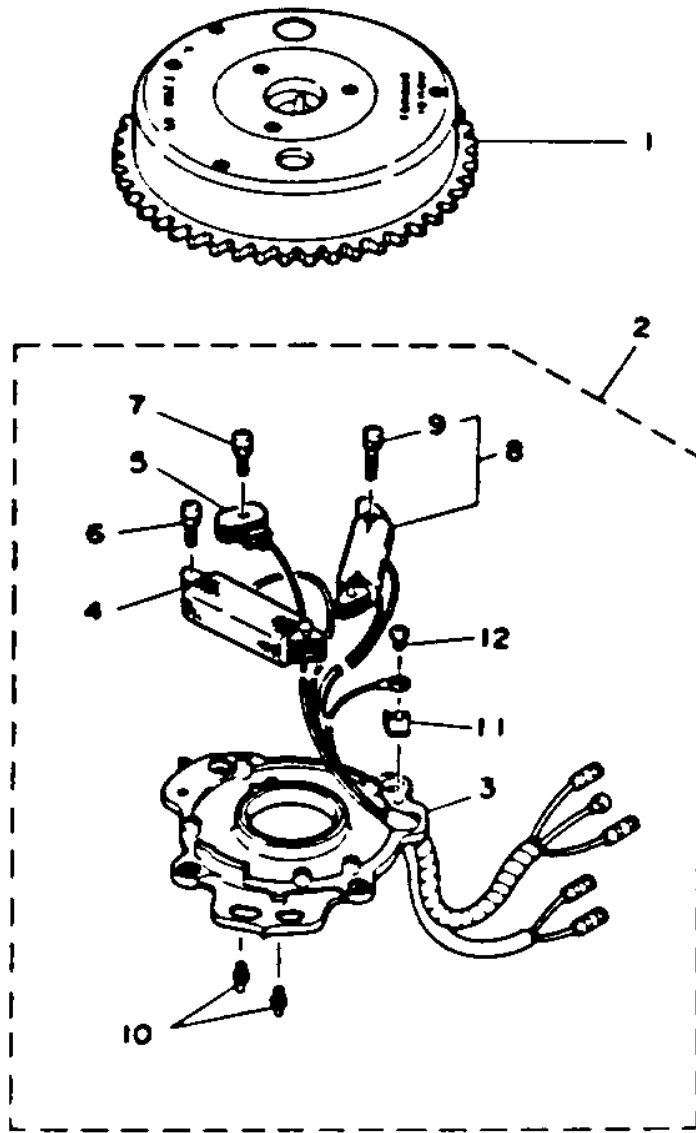

©2014 Yamaha Motor Corporation, U.S.A. All rights reserved.

## Part List

15ESHR 1993 / CDI MAGNETO (9.9E 15E)

REF - NO	PART NUMBER	PART NAME	QUANTITY	REMARKS
1	6E7-85550-A0-00	ROTOR ASSY	1	
2	6E7-85560-A0-00	BASE ASSY	1	
3	6E7-85509-70-00	.BASE, MAGNETO	1	
4	6E7-85520-70-00	.COIL, CHARGE	1	
5	6E7-85580-70-00	.COIL, PULSER	1	
6	90159-05039-00	.SCREW, W/WASHER	2	
7	90159-05038-00	.SCREW, WITH WASHER	1	
8	6E7-81303-A0-00	.LIGHTING COIL ASSY	1	
9	90159-05039-00	..SCREW, W/WASHER	2	
10	663-85518-00-00	.JOINT, BALL	2	
11	6E7-81328-70-00	.CLAMP, CORD	1	
12	98511-04006-00	.SCREW, PAN HEAD (98502-04006)	1	



15ESHR 1993 / ELECTRIC MOTOR (9.9E 15E)

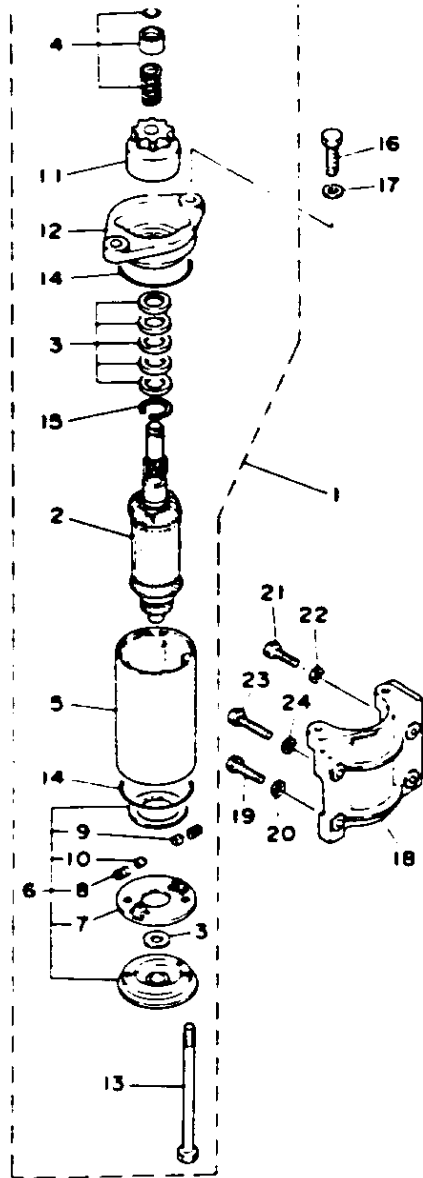

©2014 Yamaha Motor Corporation, U.S.A. All rights reserved.



## Part List

15ESHR 1993 / ELECTRIC MOTOR (9.9E 15E)

REF - NO	PART NUMBER	PART NAME	QUANTITY	REMARKS
1	682-81800-12-00	STARTING MOTOR ASSEMBLY	1	
2	682-81850-11-00	.ARMATURE ASSEMBLY	1	
3	682-81809-10-00	.WASHER KIT	1	
4	682-81833-10-00	.PINION STOPPER SET	1	
5	682-81810-11-00	.STATOR ASSY	1	
6	682-81820-10-00	.REAR COVER ASSY	1	
7	682-81840-10-00	..BRUSH HOLDER ASSY	1	
8	682-81813-10-00	..SPRING, BRUSH	2	
9	682-81811-10-00	..BRUSH 1 (+)	1	
10	682-81812-10-00	..BRUSH 2 (-)	1	
11	682-81832-10-00	.PINION ASSY	1	
12	682-81830-10-00	.FRONT COVER ASSY	1	
13	682-81826-10-00	.BOLT	2	
14	682-81847-10-00	.O-RING	2	
15	682-81834-10-00	.RING	1	
16	97013-08025-00	BOLT	2	
17	92990-08600-00	..WASHER, PLATE	2	
18	682-81822-43-94	BRACKET, ELECTRIC MOTOR (682-81822-42-94)	1	
19	97395-06020-00	BOLT, HEXAGON	2	
20	92990-06600-00	WASHER, PLATE	2	
21	97395-06025-00	BOLT	1	
22	92990-06600-00	WASHER, PLATE	1	
23	97395-06030-00	BOLT	1	
24	92990-06600-00	WASHER, PLATE	1	

## Part Notes

15ESHR 1993 / ELECTRIC MOTOR (9.9E 15E)

PART NUMBER		NOTE TEXT
92990-06600-00		OEM: This part number is among the Top 100 Most Popular Marine Maintenance Parts as of March 2014.
92990-06600-00		OEM: This part number is among the Top 100 Most Popular Marine Maintenance Parts as of March 2014.
92990-06600-00		OEM: This part number is among the Top 100 Most Popular Marine Maintenance Parts as of March 2014.

©2014 Yamaha Motor Corporation, U.S.A. All rights reserved.

15ESHR 1993 / ELECTRIC PARTS

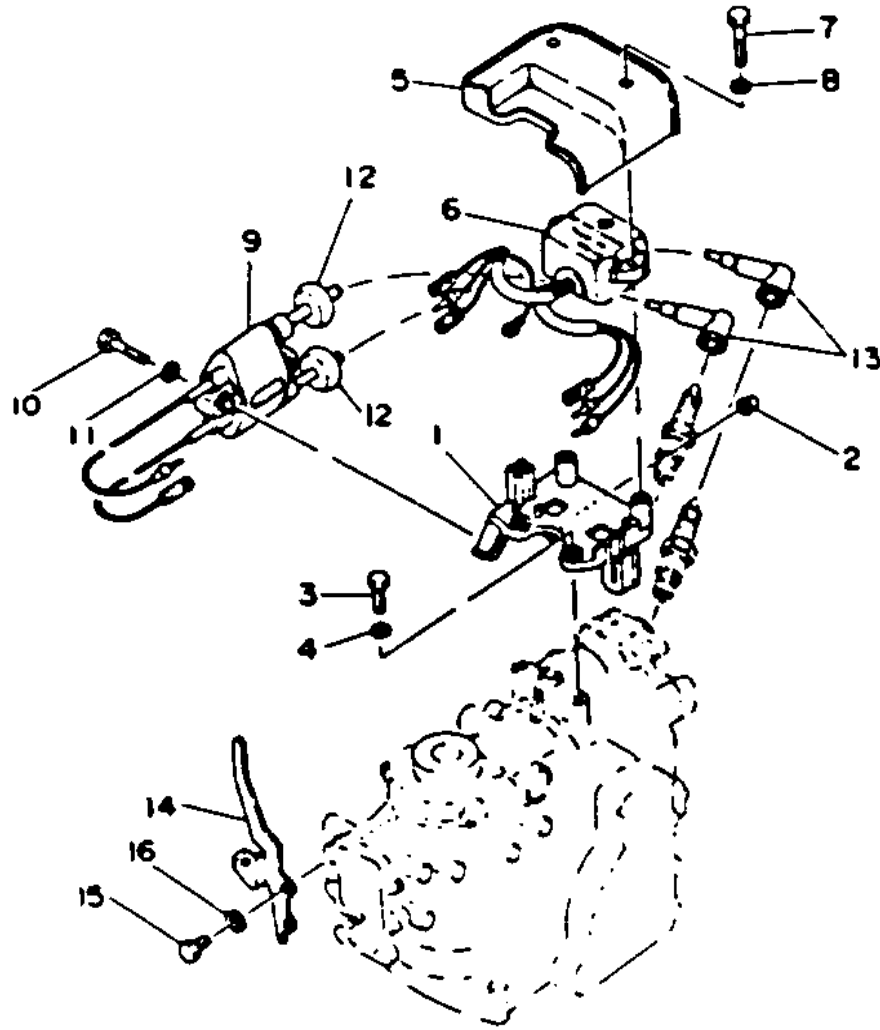

©2014 Yamaha Motor Corporation, U.S.A. All rights reserved.



## Part List

15ESHR 1993 / ELECTRIC PARTS

REF - NO	PART NUMBER	PART NAME	QUANTITY	REMARKS
1	6E7-85542-00-94	BRACKET	1	
2	6E7-82317-00-00	DAMPER, IGNITION COIL	2	
3	97395-06020-00	BOLT, HEXAGON	2	
4	92990-06600-00	WASHER, PLATE	2	
5	6E7-81916-00-00	COVER, TERMINAL	1	
6	695-85540-11-00	C.D.I. UNIT ASSEMBLY	1	
7	97395-06030-00	BOLT	2	
8	92990-06200-00	WASHER, PLAIN	2	
9	6E7-85570-19-00	IGNITION COIL ASSEMBLY	1	
10	97313-06030-00	BOLT	2	
11	92990-06600-00	WASHER, PLATE	2	
12	90480-25161-00	GROMMET	2	
13	663-82370-01-00	PLUG CAP ASSY	2	
14	682-81332-02-00	PLATE, TIMING	1	
15	97395-06016-00	BOLT, HEX	2	
16	92990-06600-00	WASHER, PLATE	2	

## Part Notes

15ESHR 1993 / ELECTRIC PARTS

PART NUMBER	NOTE TEXT
92990-06600-00 	OEM: This part number is among the Top 100 Most Popular Marine Maintenance Parts as of March 2014.
92990-06600-00 	OEM: This part number is among the Top 100 Most Popular Marine Maintenance Parts as of March 2014.
92990-06600-00 	OEM: This part number is among the Top 100 Most Popular Marine Maintenance Parts as of March 2014.

©2014 Yamaha Motor Corporation, U.S.A. All rights reserved.

15ESHR 1993 / ELECTRIC PARTS (9.9E 15E)

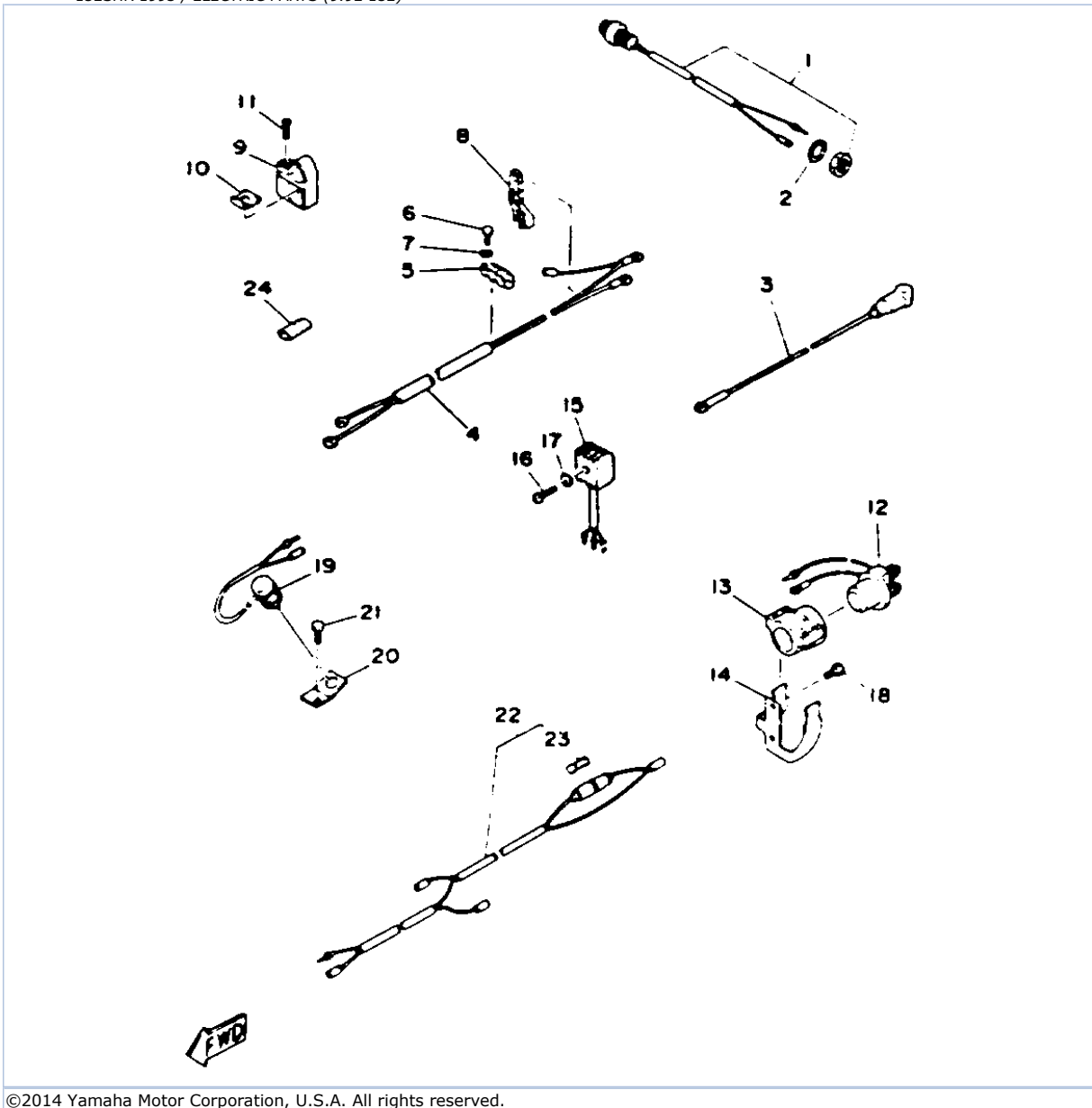

©2014 Yamaha Motor Corporation, U.S.A. All rights reserved.

## Part List

15ESHR 1993 / ELECTRIC PARTS (9.9E 15E)

REF - NO	PART NUMBER	PART NAME	QUANTITY	REMARKS
1	689-81870-00-00	STARTING SWITCH ASSY	1	
2	90201-16M36-00	WASHER, PLATE	1	
3	6E7-82117-00-00	WIRE, LEAD	1	
4	6E7-82105-10-00	BATTERY CABLE	1	
5	90464-08M03-00	CLAMP	1	
6	97395-06016-00	BOLT, HEX	2	
7	92990-06600-00	WASHER, PLATE	2	
8	682-82594-01-00	CLAMP	1	
9	689-82594-00-00	CLAMP	1	
10	682-42525-00-00	PLATE, FRICTION 1	1	
11	90161-06M03-00	SCREW, TAPPING	1	
12	6G1-81941-10-00	STARTER RELAY ASSY	1	
13	6G1-81952-00-00	HOLDER, RELAY	1	
14	6E7-81945-00-00	PLATE, SWITCH FITTING	1	
15	664-81970-61-00	RECTIFIER ASSEMBLY	1	
16	98580-05525-00	SCREW, PAN HEAD	1	
17	92990-05600-00	WASHER, PLATE	1	
18	97395-06014-00	BOLT	2	
19	689-82540-01-00	NEUTRAL SWITCH ASSEMBLY	1	
20	682-82554-00-00	STAY, NEUTRAL SWITCH	1	
21	97395-06012-00	BOLT	1	
22	6E7-82541-00-00	WIRE, LEAD	1	
23	682-82151-00-00	.FUSE (12V-20A)	1	
24	90446-10M02-00	HOSE	1	

## Part Notes

15ESHR 1993 / ELECTRIC PARTS (9.9E 15E)

PART NUMBER	NOTE TEXT
92990-06600-00 	OEM: This part number is among the Top 100 Most Popular Marine Maintenance Parts as of March 2014.

©2014 Yamaha Motor Corporation, U.S.A. All rights reserved.

15ESHR 1993 / REPAIR KIT 1

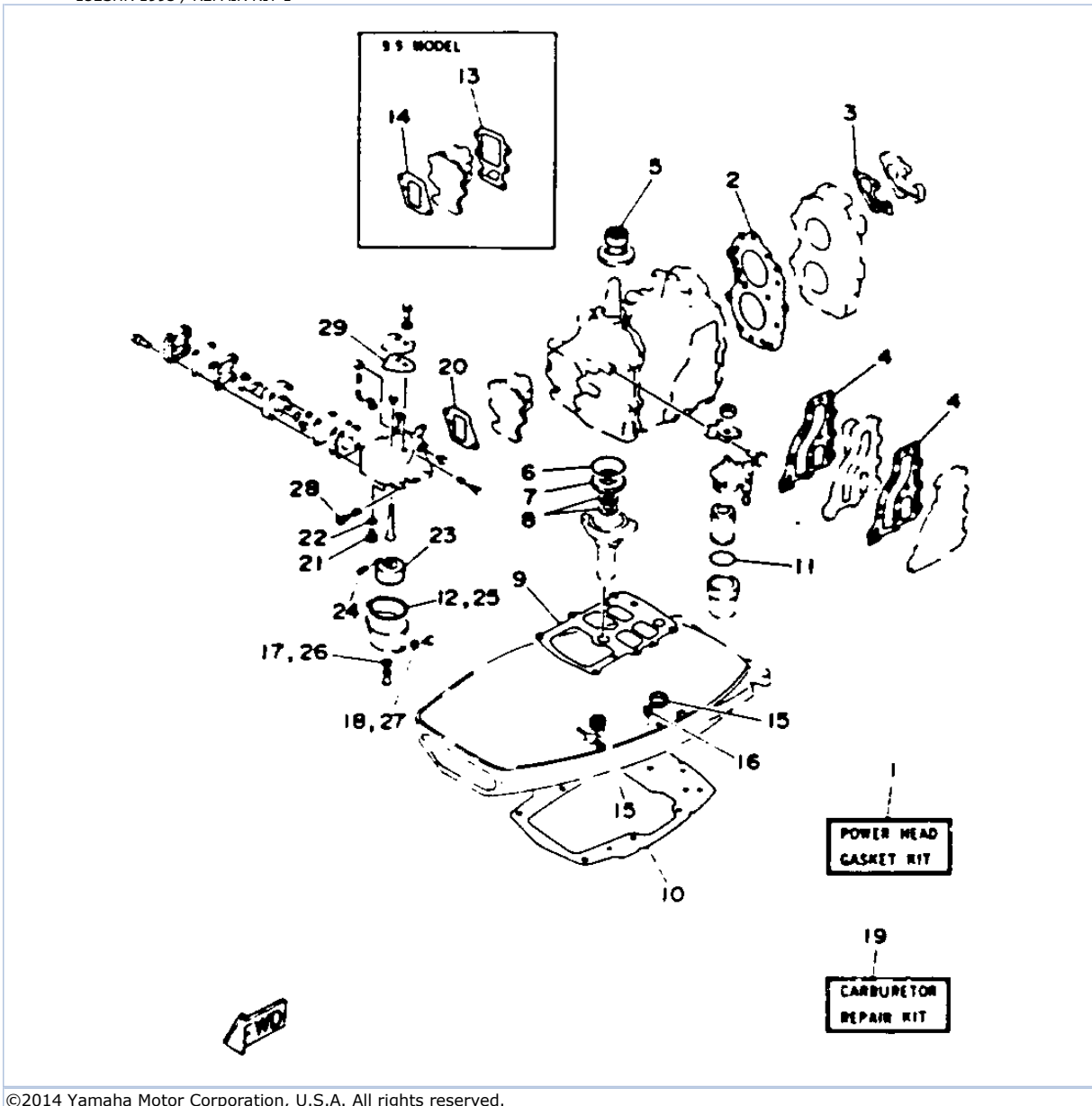

©2014 Yamaha Motor Corporation, U.S.A. All rights reserved.

## Part List

15ESHR 1993 / REPAIR KIT 1

REF - NO	PART NUMBER	PART NAME	QUANTITY	REMARKS
1	6E7-W0001-01-00	GASKET KIT	1	UR 9.9
1	682-W0001-05-00	GASKET KITGASKET KIT	1	UR 15
2	6E7-11181-A0-00	.GASKET, CYLINDER HEAD 1	1	
3	682-12414-A1-00	.GASKET, COVER	1	
4	682-41112-A1-00	.GASKET, EXHAUST INNER COVER	2	
5	93110-23M00-00	.OIL SEAL	1	
6	93210-53679-00	.O-RING	1	
7	93101-20M29-00	.OIL SEAL	1	
8	93101-13M11-00	.OIL SEAL	2	
9	682-11351-A0-00	.GASKET, CYLINDER	1	
10	682-45113-A1-00	.GASKET, UPPER CASING	1	
11	93210-37M25-00	.O-RING	1	
12	677-14384-01-00	.GASKET, FLOAT CHAMBER	1	
13	682-13621-A0-00	.GASKET, VALVE SEAT	1	9.9
14	677-14198-A0-00	.GASKET	1	9.9
15	682-44367-00-00	.DAMPER, WATER SEAL	2	
16	682-44366-00-00	.DAMPER, WATER SEAL	1	
17	1J2-14398-00-00	.GASKET	1	
18	655-14398-00-00	.GASKET	1	
19	6E7-W0093-03-00	CARBURETOR REPAIR KIT	1	UR 9.9
19	6E8-W0093-00-00	CARBURETOR REPAIR KIT	1	UR 1.5
20	677-14198-A0-00	.GASKET	1	9.9
21	6E8-14390-12-00	.NEEDLE VALVE ASSEMBLY	1	UR 9.9
21	61J-14390-00-00	.NEEDLE VALVE ASSEMBLY	1	UR 15
22	367-14195-00-00	.GASKET	1	
23	6E7-14385-00-00	.FLOAT	1	
24	647-14386-10-00	.PIN, FLOAT	1	
25	677-14384-01-00	.GASKET, FLOAT CHAMBER	1	
26	1J2-14398-00-00	.GASKET	1	
27	655-14398-00-00	.GASKET	1	
28	647-14323-00-00	.SCREW, AIR ADJUSTING	1	
29	6E7-14227-00-00	.GASKET	1	



15ESHR 1993 / REPAIR KIT 2

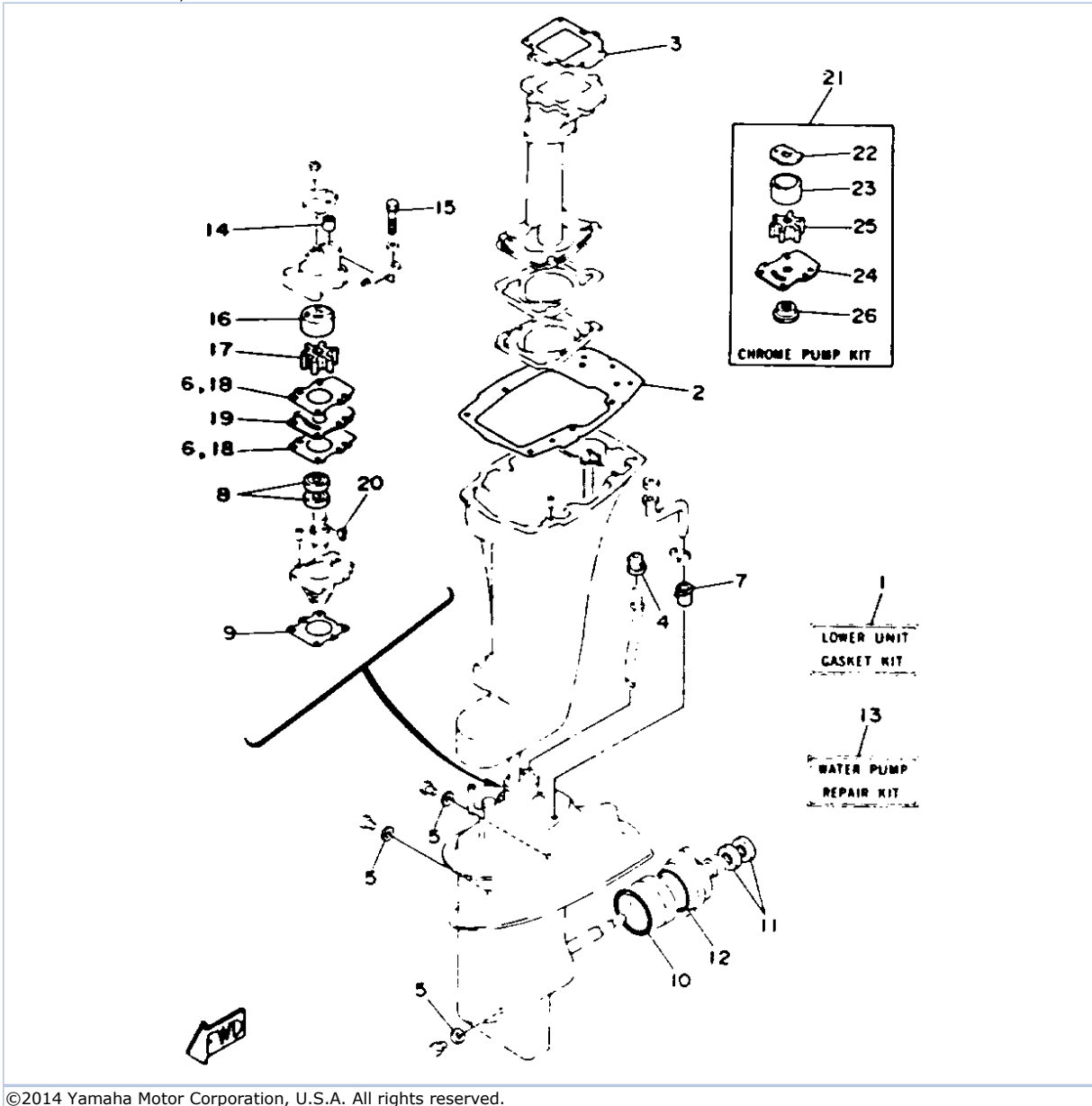

©2014 Yamaha Motor Corporation, U.S.A. All rights reserved.

## Part List

15ESHR 1993 / REPAIR KIT 2

REF - NO	PART NUMBER	PART NAME	QUANTITY	REMARKS
1	683-W0001-22-00	LOWER UNIT GASKET KIT	1	
2	682-45113-A1-00	.GASKET, UPPER CASING	1	
3	682-41133-A0-00	.GASKET, EXHAUST MANIFOLD 1	1	
4	626-44365-01-00	.DAMPER, WATER SEAL	1	
5	90430-08020-00	.GASKET	3	
6	682-44315-A0-00	.GASKET, WATER PUMP	2	
7	6E7-44366-00-00	.DAMPER, WATER SEAL	1	
8	93101-20048-00	.OIL SEAL	2	
9	683-45315-A0-00	.PACKING, LOWER CASING	1	
10	93210-57M09-00	.O-RING	1	
11	93101-17054-00	.OIL SEAL	2	
12	93210-56M80-00	.O-RING	1	
13	682-W0078-01-00	WATER PUMP REPAIR KIT	1	
14	682-44365-00-00	.DAMPER, WATER SEAL	1	
15	97395-06040-00	.BOLT	4	
16	682-44322-00-00	.INSERT, CARTRIDGE	1	
17	682-44352-01-00	.IMPELLER	1	
18	682-44315-A0-00	.GASKET, WATER PUMP	2	
19	682-44323-00-00	.OUTER PLATE, CARTRIDGE	1	
20	90280-03024-00	.KEY, WOODRUFF	1	
21	682-W0078-0A-00	CHROME PUMP KIT	1	
22	682-44321-40-00	.INNER PLATE, CARTRIDGE	1	
23	682-44322-40-00	.INSERT, CARTRIDGE	1	
24	682-44323-40-00	.OUTER PLATE, CARTRIDGE	1	
25	682-44352-01-00	.IMPELLER	1	
26	682-45344-00-00	.COVER, OIL SEAL	1	

## Part Notes

15ESHR 1993 / REPAIR KIT 2

PART NUMBER	NOTE TEXT
90430-08020-00 	OEM: This part number is among the Top 100 Most Popular Marine Maintenance Parts as of March 2014.

©2014 Yamaha Motor Corporation, U.S.A. All rights reserved.

©2014 Yamaha Motor Corporation, U.S.A. All rights reserved.