

P200TLRS 1994 / CYLINDER CRANKCASE 1

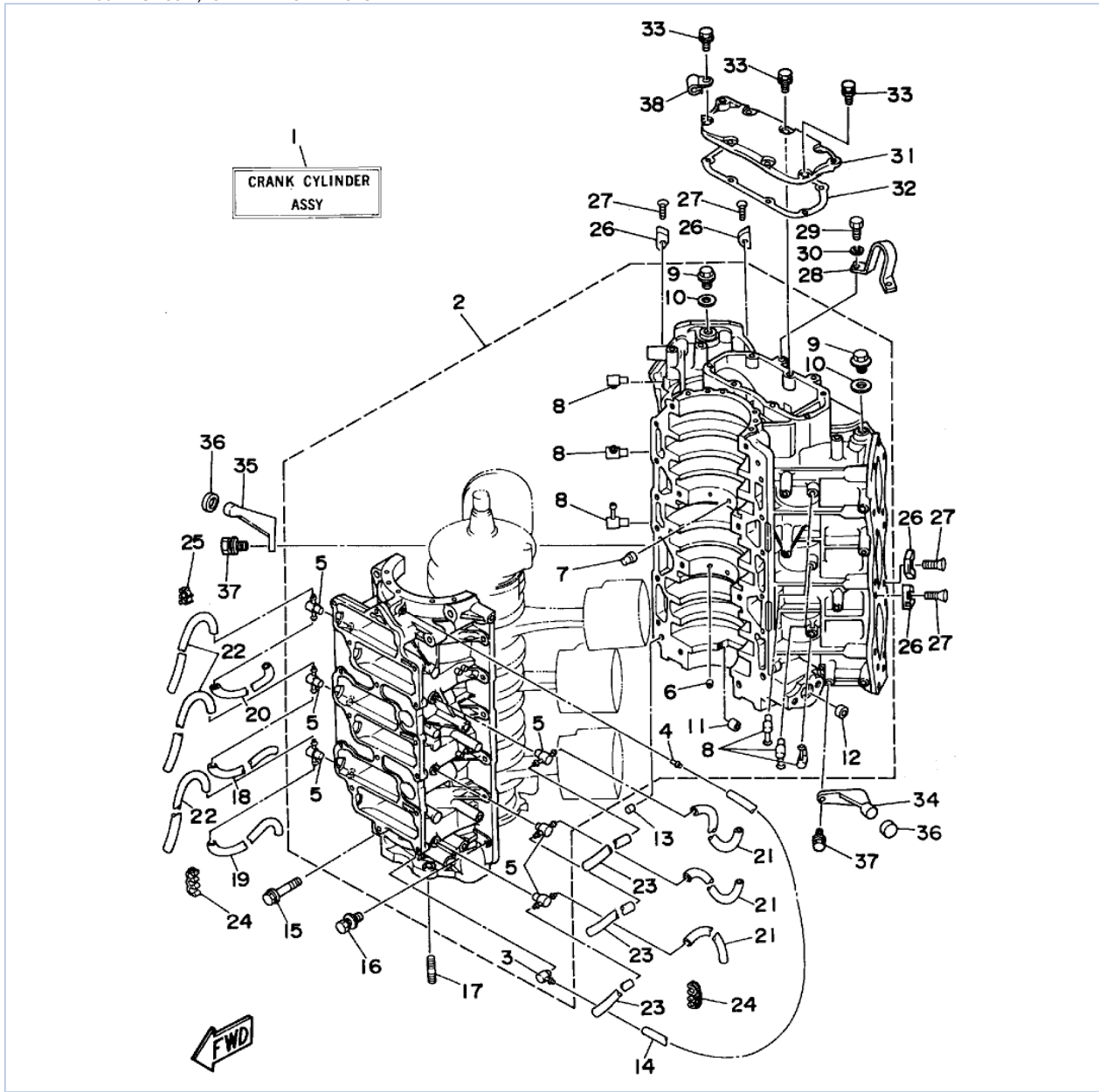

©2013 Yamaha Motor Corporation, U.S.A. All rights reserved.

Part List

P200TLRS 1994 / CYLINDER CRANKCASE 1

REF - NO	PART NUMBER	PART NAME	QUANTITY	REMARKS
1	6N9-W0090-16-4D	CRANK CYLINDER ASSEMBLY (REF. #2~30, CYLINDER-CRANKCA)	1	UR P150/P175
1	61H-W0090-15-4D	CRANK CYLINDER ASSEMBLY (61H-W0090-14-4D) (REF. #2~30,)	1	UR P200
2	62H-15100-00-94	CRANKCASE ASSEMBLY	1	UR P150/P175
2	61H-15100-01-94	CRANKCASE ASSEMBLY	1	UR P200
3	6E5-11372-00-00	.NIPPLE, HOSE	1	
4	624-14485-00-00	.PIPE, JOINT	1	
5	6F6-11372-00-00	.NIPPLE, HOSE	6	
6	624-11379-00-00	.VALVE, CHECK	2	
7	663-11518-01-00	.LOCK, BEARING	2	
8	646-11370-00-00	.CHECK VALVE ASSY	6	
9	90340-14M00-00	.PLUG, STRAIGHT SCREW	2	
10	90430-14115-00	.GASKET	2	
11	90384-06M07-00	.BUSH, BIMETAL FORMED	1	
12	90384-14M09-00	.BUSH, BIMETAL FORMED	1	
13	93608-12063-00	PIN, DOWEL	2	
14	90445-07M10-00	HOSE (L510)	1	
15	90105-10M20-00	BOLT, FLANGE	8	
16	90119-08M23-00	BOLT, W/WASHER	12	
17	90116-08M45-00	BOLT, STUD	2	
18	90445-07M11-00	HOSE (L610)	1	
19	90445-07M09-00	HOSE (L380)	1	
20	90445-07240-00	HOSE (L330)	1	
21	90445-07MA4-00	HOSE (L280)	3	
22	90445-07257-00	HOSE	3	
23	90445-07M03-00	.HOSE (L34)	3	
24	90464-07M05-00	CLAMP	2	
25	90464-07M20-00	CLAMP	1	
26	6E5-11325-00-00	ANODE	8	
27	98680-04016-00	SCREW OVAL HEAD	8	
28	6E5-11119-00-00	HANGER, ENGINE	1	
29	97313-08020-00	BOLT, HEXAGON	2	
30	92990-08100-00	WASHER, SPRING	2	
31	6K7-11371-01-9M	COVER	1	
32	6E5-11381-A1-00	GASKET 1	1	
33	97595-06520-00	BOLT, WITH WASHER	7	
34	6E5-42761-00-94	STOPPER	1	
35	6E5-42762-00-94	STOPPER	1	
36	663-44533-00-00	DAMPER, UPPER MOUNT RUBBER	2	
37	97595-06520-00	BOLT, WITH WASHER	4	
38	90465-08028-00	CLAMP	1	

P200TLRS 1994 / CYLINDER CRANKCASE 2

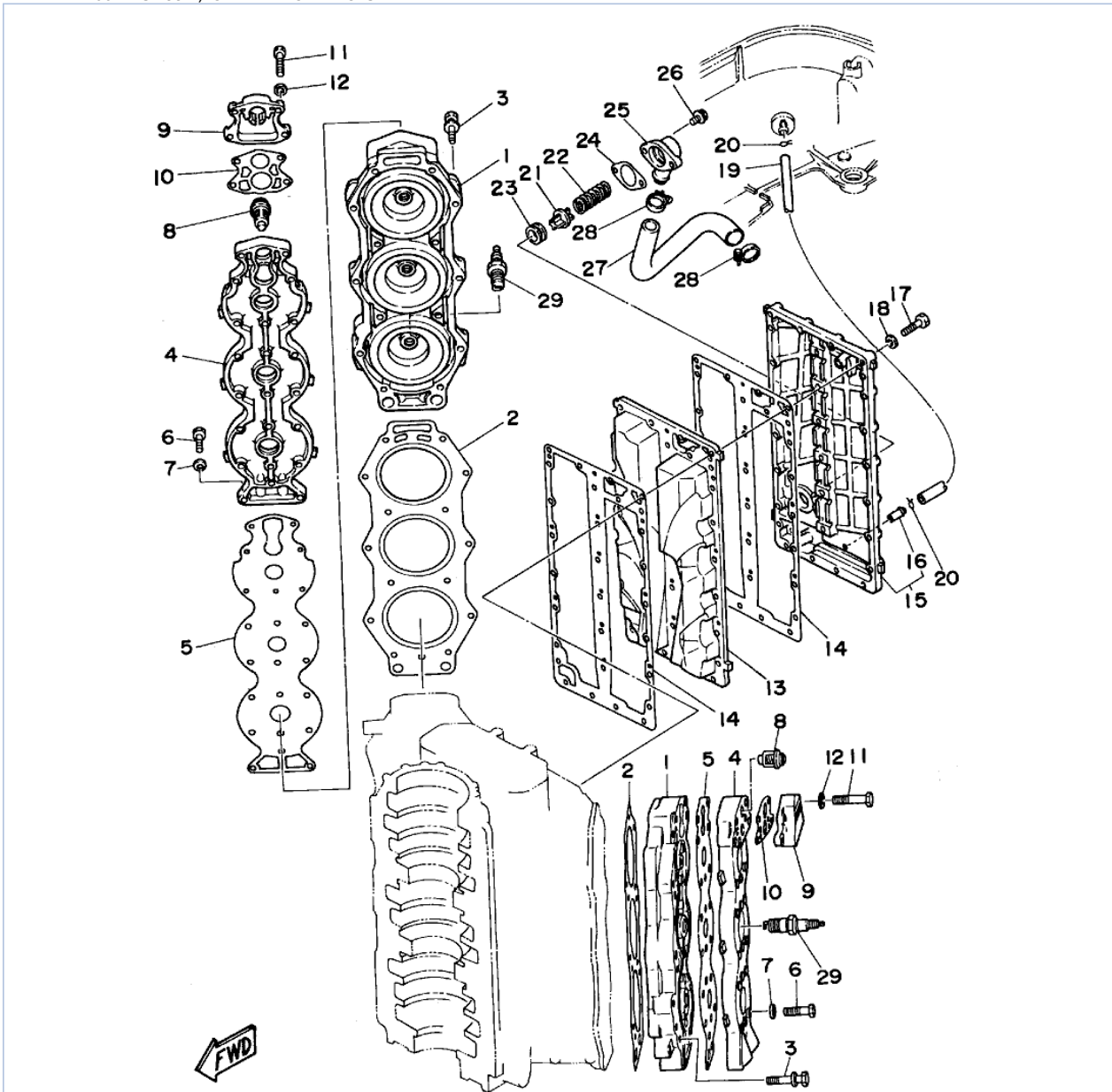

©2013 Yamaha Motor Corporation, U.S.A. All rights reserved.





Part List

P200TLRS 1994 / CYLINDER CRANKCASE 2

REF - NO	PART NUMBER	PART NAME	QUANTITY	REMARKS
1	6G4-11111-02-94	HEAD, CYLINDER 1	2	UR P150/P175
1	6R5-11111-01-94	HEAD, CYLINDER 1	2	UR P200
2	6G5-11181-A0-00	GASKET, CYLINDER HEAD 1	2	
3	90119-08M21-00	BOLT, WITH WASHER	28	
4	6G5-11191-00-9M	COVER, CYLINDER HEAD 1	2	
5	6G5-11193-A0-00	.GASKET, HEAD COVER 1	2	
6	97095-06030-00	BOLT	36	
7	92990-06600-00	WASHER, PLATE	36	
8	6E5-12411-20-00	THERMOSTAT	2	
9	6G5-12413-00-9M	COVER, THERMOSTAT	2	
10	688-12414-A1-00	.GASKET, COVER	2	
11	97313-06045-00	BOLT, HEXAGON	8	
12	92990-06600-00	WASHER, PLATE	8	
13	6G5-41111-00-9M	INNER COVER, EXHAUST	1	
14	6G5-41112-A1-00	GASKET, EXHAUST INNER COVER	2	
15	6R3-41113-00-9M	OUTER COVER, EXHAUST	1	
16	652-24461-00-00	.PIPE, JOINT 4	1	
17	97013-06035-00	BOLT	29	
18	92990-06600-00	WASHER, PLATE	29	
19	6E5-24312-00-00	PIPE 2	1	
20	90467-08004-00	CLIP	2	
21	6G5-12416-00-00	VALVE, PRESSURE CONTROL	1	
22	90501-16M11-00	SPRING, COMPRESSION	1	
23	90480-20M05-00	GROMMET	1	
24	6G5-11382-A1-00	.GASKET 2	1	
25	6G5-11372-00-5B	NIPPLE, HOSE (6G5-11372-00-9M)	1	
26	97595-06520-00	BOLT, WITH WASHER	2	
27	6G5-12576-00-00	HOSE 1	1	
28	90465-13M36-00	CLAMP	2	
29	NGK-BR9HS-10-00	PLUG, SPARK (NGK BR9HS-10)	6	UR P200
29	NGK-BR8HS-10-00	PLUG, SPARK (NGK BR8HS-10)	6	UR P150/P175

Part Notes

P200TLRS 1994 / CYLINDER CRANKCASE 2

PART NUMBER		NOTE TEXT
92990-06600-00		OEM: This part number is among the Top 100 Most Popular Marine Maintenance Parts as of August 2013.
688-12414-A1-00		OEM: This part number is among the Top 100 Most Popular Marine Maintenance Parts as of August 2013.
92990-06600-00		OEM: This part number is among the Top 100 Most Popular Marine Maintenance Parts as of August 2013.
92990-06600-00		OEM: This part number is among the Top 100 Most Popular Marine Maintenance Parts as of August 2013.
90480-20M05-00		OEM: This part number is among the Top 100 Most Popular Marine Maintenance Parts as of August 2013.

©2013 Yamaha Motor Corporation, U.S.A. All rights reserved.

Part List

P200TLRS 1994 / CRANKSHAFT PISTON

REF - NO	PART NUMBER	PART NAME	QUANTITY	REMARKS
1	6R3-11411-00-00	CRANKSHAFT	1	
2	6E5-11447-00-00	SEAL, CRANK	9	
3	6R3-15163-00-94	HOUSING, BEARING 1	1	
4	93311-940U3-00	BEARING	1	
5	93102-40M38-00	OIL SEAL	1	
6	93211-04384-00	.O-RING	2	
7	97595-06520-00	BOLT, WITH WASHER	3	
8	93310-954V3-00	BEARING, CYLINDRICAL	2	
9	93306-208U0-00	BEARING	1	
10	93410-40M03-00	CIRCLIP	1	
11	6R5-11631-11-93	PISTON (STD)	3	UR P200
11	6R5-11636-11-00	PISTON (0.50MM O/S)	3	UR AP P200
11	61H-11631-11-92	PISTON (STD)	3	UR P150/P175
11	61H-11636-11-00	PISTON (0.50MM O/S)	3	UR AP P150/P175
12	61H-11642-11-92	PISTON 2 (STD)	3	UR P150/P175
12	61H-11646-11-00	PISTON 2 (0.50MM O/S)	3	UR AP P150/P175
12	6R5-11642-11-93	PISTON 2 (STD)	3	UR P200
12	6R5-11646-11-00	PISTON 2 (0.50MM O/S)	3	UR AP P200
13	6R5-11603-00-00	PISTON RING SET (STD)	6	
13	6R5-11605-00-00	PISTON RING SET (0.50MM O/S)	6	AP
14	6R5-11633-10-00	PIN, PISTON	6	
15	6R5-11634-10-00	CLIP, PISTON PIN	12	
16	6R5-11650-10-00	CONNECTING ROD ASSY	6	
17	90109-08M61-00	.BOLT	2	
18	93310-323V6-00	BEARING	6	
19	90201-23M01-00	WASHER, PLATE	12	
20	93310-836U0-00	BEARING	6	
21	6G5-15359-00-94	HOUSING, OIL SEAL	1	
22	93102-35M13-00	OIL SEAL	1	
23	93101-22M15-00	.OIL SEAL	1	
24	93210-74M35-00	.O-RING	1	
25	97595-06520-00	BOLT, WITH WASHER	4	

P200TLRS 1994 / INTAKE

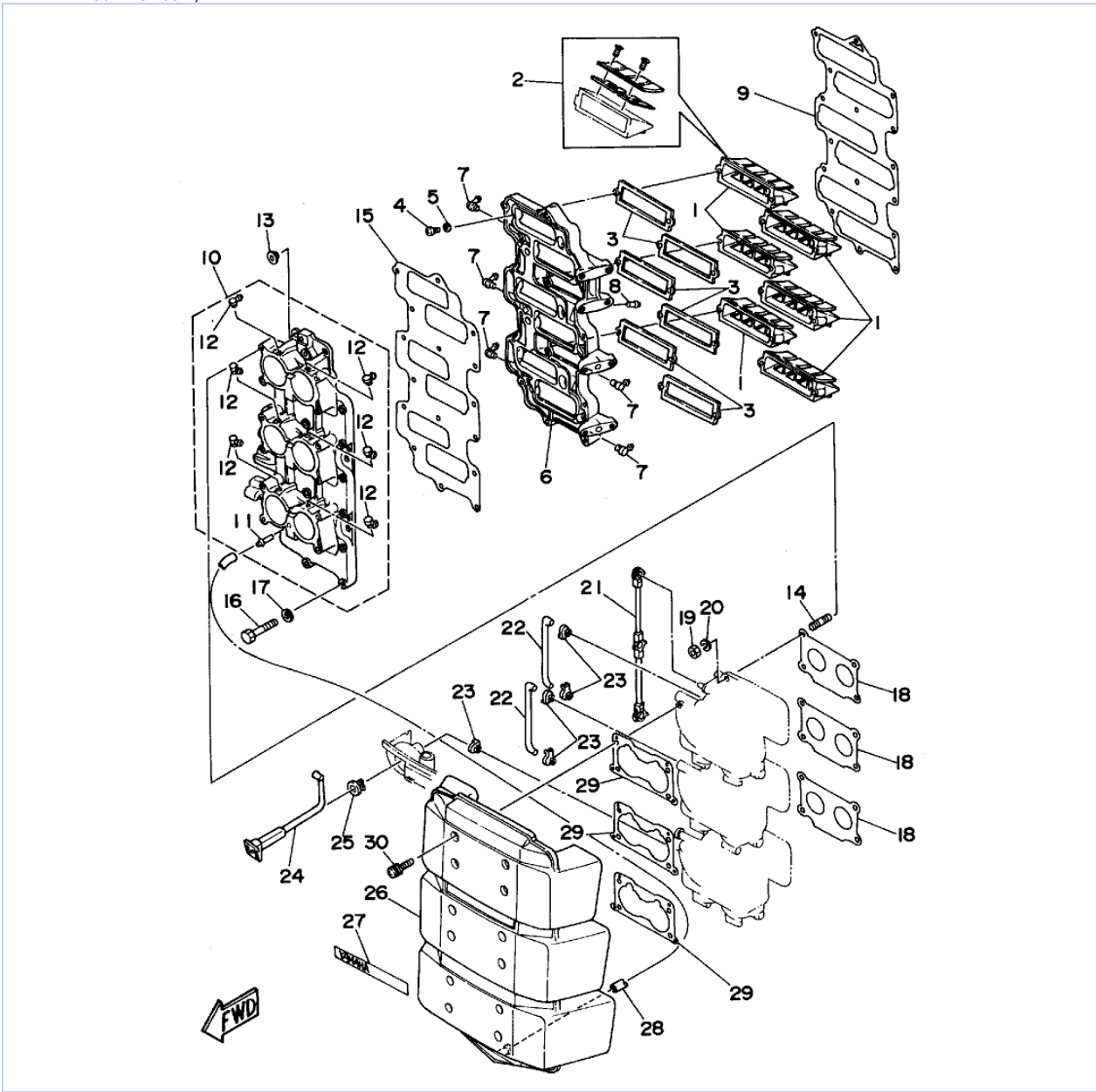

©2013 Yamaha Motor Corporation, U.S.A. All rights reserved.



Part List

P200TLRS 1994 / INTAKE

REF - NO	PART NUMBER	PART NAME	QUANTITY	REMARKS
1	6K7-13610-00-00	REED VALVE ASSY	6	UR P175
1	61H-13610-01-00	REED VALVE ASSEMBLY	6	UR P150/P200
2	61H-W0004-01-00	.REED SET	1	UR P150/P200
2	6E5-W0004-00-00	.REED SET	1	UR P175
3	6K7-13621-A1-00	.GASKET, VALVE SEAT	6	
4	98580-05016-00	SCREW, PAN HEAD	12	
5	92990-05600-00	WASHER, PLATE	12	
6	61H-13624-00-94	PLATE, REED VALVE	1	
7	6H4-11372-00-00	.NIPPLE, HOSE	5	
8	6R5-14485-00-00	.PIPE, JOINT	1	
9	6K7-13646-A1-00	GASKET, MANIFOLD 2	1	
10	61H-13641-00-94	MANIFOLD 1	1	
11	624-14485-00-00	.PIPE, JOINT	1	
12	6E5-13552-00-00	.NOZZLE	6	
13	90480-10M28-00	GROMMET	6	
14	90116-06M30-00	BOLT, STUD	12	
15	6K7-13645-A1-00	GASKET, MANIFOLD 1	1	
16	97313-06050-00	BOLT	16	
17	92990-06600-00	WASHER, PLATE	16	
18	6E5-14198-A1-00	GASKET	3	
19	95604-06200-00	.NUT, U FLANGE	12	
20	92995-06100-00	WASHER, SPRING	12	
21	6G5-41217-01-00	ROD, ACCEL. LEVER	1	
22	6E5-41256-01-00	ROD, CHOKE 1	2	
23	661-41262-02-00	JOINT, CHOKE LEVER	5	
24	61H-41271-00-00	KNOB, CHOKE	1	
25	689-41273-00-00	GROMMET	1	
26	6K7-14440-00-00	SILENCER ASSEMBLY, INTAKE	1	
27	6G5-1441K-00-00	EMBLEM	1	
28	90445-07M02-00	HOSE (L167)	1	
29	6K7-14483-00-00	GASKET	3	
30	90159-06M08-00	SCREW, WITH WASHER	12	

Part Notes

P200TLRS 1994 / INTAKE

PART NUMBER		NOTE TEXT
92990-06600-00		OEM: This part number is among the Top 100 Most Popular Marine Maintenance Parts as of August 2013.
92995-06100-00		OEM: This part number is among the Top 100 Most Popular Marine Maintenance Parts as of August 2013.

©2013 Yamaha Motor Corporation, U.S.A. All rights reserved.

P200TLRS 1994 / CARBURETOR

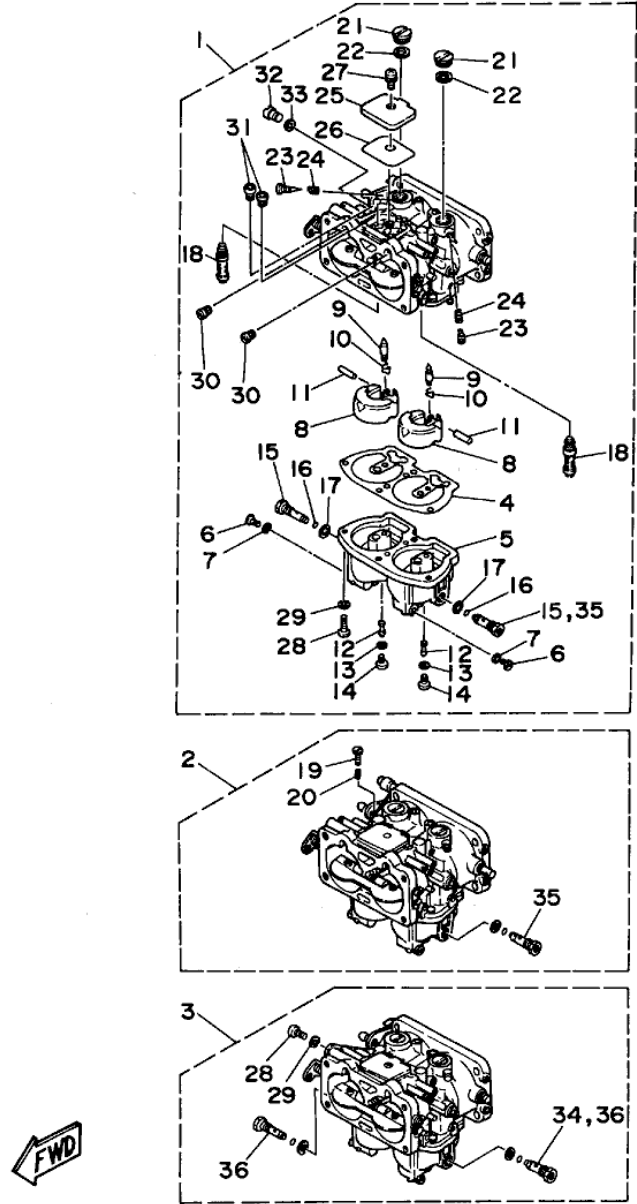

©2013 Yamaha Motor Corporation, U.S.A. All rights reserved.

Part List

P200TLRS 1994 / CARBURETOR

REF - NO	PART NUMBER	PART NAME	QUANTITY	REMARKS
1	61H-14301-03-00	CARBURETOR ASSEMBLY 1	1	UR P200
1	6N9-14301-02-00	CARBURETOR ASSEMBLY 1	1	UR P150
1	62H-14301-00-00	CARBURETOR ASSEMBLY 1	1	UR P175
2	6N9-14302-02-00	CARBURETOR ASSEMBLY 2	1	UR P150
2	62H-14302-00-00	CARBURETOR ASSEMBLY 2	1	UR P175
2	61H-14302-03-00	CARBURETOR ASSEMBLY 2	1	UR P200
3	62H-14303-00-00	CARBURETOR ASSEMBLY 3	1	UR P175
3	61H-14303-03-00	CARBURETOR ASSEMBLY 3	1	UR P200
3	6N9-14303-02-00	CARBURETOR ASSEMBLY 3	1	UR P150
4	6E5-14384-03-00	.GASKET, FLOAT CHAMBER	3	
5	6E5-14381-03-00	.BODY, FLOAT CHAMBER	3	
6	6E5-14383-01-00	.SCREW, DRAIN	6	
7	6J8-14995-00-00	.GASKET	6	
8	6E5-14385-02-00	.FLOAT	6	
9	6E5-14546-00-00	.VALVE, NEEDLE	6	
10	6E5-14159-00-00	.CLIP	6	
11	6E5-14386-02-00	.PIN, FLOAT	6	
12	6E5-1492F-40-00	.JET, AIR SLOW (#80)	6	P175/P200
12	6E5-1492F-38-00	.JET, AIR SLOW (#76)	6	UR P150
13	6E5-14397-00-00	.O-RING	6	
14	6E5-14394-00-00	.PLUG, SLOW JET	6	
15	6E5-1492E-77-00	.JET, MAIN (#154)	4	UR P175
15	6E5-1492E-77-00	.JET, MAIN (#154)	6	UR P200
15	6E5-1492E-63-00	.JET, MAIN (#126)	3	UR P150
16	6E5-14997-00-00	.O-RING	6	
17	6E5-14398-01-00	.GASKET	6	
18	6G6-1492A-00-00	.NOZZLE, MAIN	6	UR P175
18	6G5-1492A-00-00	.NOZZLE, MAIN	6	UR P150
18	6R5-1492A-00-00	.NOZZLE, MAIN	6	UR P200
19	6E5-14321-00-00	.SCREW, THROTTLE	1	CENTER
20	6J8-14334-00-00	.SPRING, THROTTLE	1	CENTER
21	6E5-14328-01-00	.PLUG	6	
22	6E5-14979-00-00	.GASKET	6	
23	6E5-14323-03-00	.SCREW, AIR ADJUSTING	6	
24	6E5-14223-00-00	.SPRING, AIR ADJUSTING	6	
25	6E5-14527-01-00	.PLATE	3	
26	6E5-14959-01-00	.GASKET	3	
27	97980-05108-00	.SCREW, WITH WASHER	3	
28	98580-05016-00	.SCREW, PAN HEAD	13	
29	92990-05100-00	.WASHER, SPRING	13	
30	61A-1492H-12-00	.JET, SLOW AIR BLEED (#60)	6	
31	61A-1492G-58-00	.JET, MAIN AIR BLEED	6	UR P175
31	61A-1492G-44-00	.JET, MAIN AIR BLEED	6	UR P150
31	61A-1492G-48-00	.JET, MAIN AIR BLEED (#240)	6	UR P200
32	6E5-14324-00-00	.SCREW, FLAT HEAD	3	
33	6J8-14995-00-00	.GASKET	3	
34	6E5-1492E-68-00	.JET, MAIN (#136) (P150)	1	LOWER
35	6E5-1492E-65-00	.JET, MAIN (#130) (P150)	2	UPPER/ CENTER
36	6E5-1492E-79-00	.JET, MAIN (#158)	2	LOWER

P200TLRS 1994 / OIL PUMP

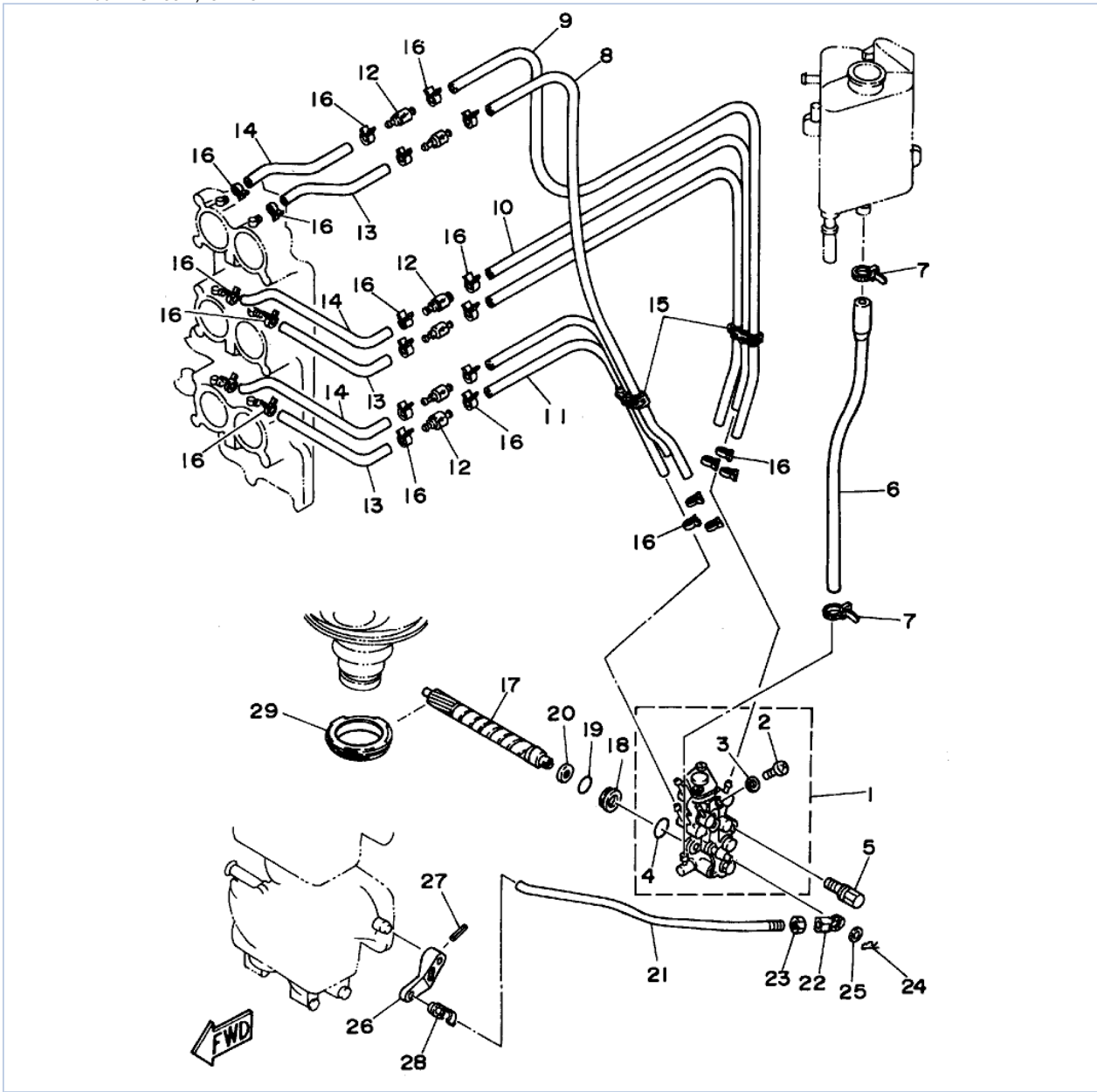

©2013 Yamaha Motor Corporation, U.S.A. All rights reserved.

Part List

P200TLRS 1994 / OIL PUMP

REF - NO	PART NUMBER	PART NAME	QUANTITY	REMARKS
1	6R4-13200-00-00	OIL INJECTION PUMP ASSY	1	UR P150/P175
1	6R5-13200-10-00	OIL INJECTION PUMP ASSEMBLY	1	UR P200
2	716-24444-00-00	.PLUG, DRAIN	1	
3	1YU-13187-00-00	.GASKET, BREATHER BOLT	1	
4	93210-19MA7-00	.O-RING	1	
5	90109-06M40-00	BOLT	2	
6	6R3-13416-00-00	PIPE, OIL 1	1	
7	90465-11M10-00	CLAMP	2	
8	90445-07M77-00	HOSE	1	
9	90445-07M85-00	HOSE (L330)	1	
10	90445-07M72-00	HOSE (L250)	2	
11	90445-07M02-00	HOSE (L167)	2	
12	6R3-13183-10-00	VALVE, CHECK	6	
13	90445-07M87-00	HOSE (L110)	3	
14	90445-07M07-00	HOSE (L180)	3	
15	90464-07M05-00	CLAMP	2	
16	90468-07M02-00	CLIP	24	
17	6R3-11537-00-00	GEAR, DRIVEN	1	
18	6R3-13117-00-00	COLLAR, DISTANCE	1	
19	93210-13595-00	O-RING	1	
20	90202-08M44-00	WASHER, PLATE	1	
21	6R5-41241-00-00	ROD, LINK	1	
22	6H1-41237-00-00	JOINT, LINK	1	
23	95380-05600-00	NUT	1	
24	90468-05M03-00	CLIP	1	
25	90202-05088-00	WASHER, PLATE	1	
26	6E5-14276-01-00	LEVER	1	
27	91690-30016-00	PIN, SPRING	1	
28	6R5-41237-00-00	JOINT, LINK	1	
29	6R3-11536-00-00	GEAR, DRIVE	1	

Part Notes

P200TLRS 1994 / OIL PUMP

PART NUMBER	NOTE TEXT
6H1-41237-00-00 	OEM: This part number is among the Top 100 Most Popular Marine Maintenance Parts as of August 2013.

©2013 Yamaha Motor Corporation, U.S.A. All rights reserved.

P200TLRS 1994 / OIL TANK

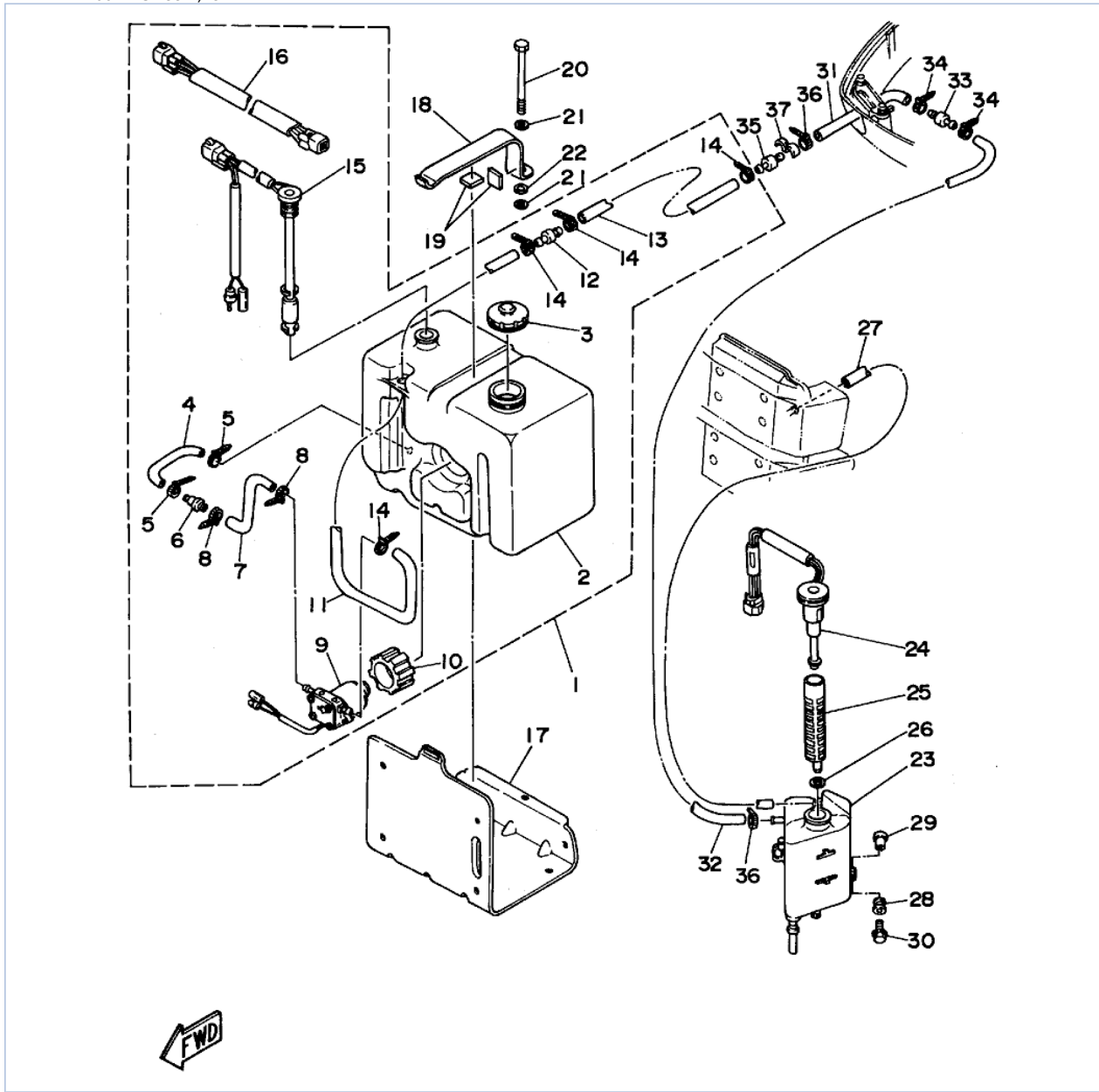

©2013 Yamaha Motor Corporation, U.S.A. All rights reserved.



Part List

P200TLRS 1994 / OIL TANK

REF - NO	PART NUMBER	PART NAME	QUANTITY	REMARKS
1	6E5-21708-06-00	OIL TANK SUB-ASSEMBLY	1	
2	6E5-21733-02-00	.SUB TANK, OIL (105L)	1	
3	6E5-21770-03-00	.OIL TANK CAP ASSY	1	
4	6E5-24322-00-00	.PIPE 11	1	
5	90465-11M10-00	.CLAMP	2	
6	646-24251-02-00	.STRAINER 1	1	
7	6E5-24319-01-00	.PIPE, OIL	1	
8	90465-11M10-00	.CLAMP	2	
9	6E5-81900-01-00	.OIL FEED PUMP ASSY	1	
10	6E5-81922-00-00	.GROMMET	1	
11	6E5-24321-01-00	.PIPE 10	1	
12	6E5-24379-00-00	.PIPE, JOINT 4	1	
13	90445-11M81-00	.HOSE (L3000)	1	
14	90465-11M10-00	.CLAMP	4	
15	6E5-85720-03-00	.OIL LEVEL GAUGE ASSEMBLY	1	
16	6R3-82553-30-00	.EXTENSION, WIRE LEAD (L=30M)	1	
17	6E5-21734-01-33	HOLDER, OIL SUB TANK	1	
18	6E5-21798-01-33	BRACKET, DAMPER	1	
19	6E5-21746-00-00	DAMPER	2	
20	97380-06100-00	BOLT, HEXAGON (91201-06100)	1	
21	92990-06600-00	WASHER, PLATE	2	
22	95604-06200-00	.NUT, U FLANGE	1	
23	6E5-21750-05-00	OIL TANK ASSY	1	
24	6R3-85730-02-00	OIL LEVEL GAUGE ASSY	1	
25	6E5-13411-00-00	STRAINER, OIL	1	
26	6E5-13414-00-00	GASKET, STRAINER COVER	1	
27	90445-05M02-00	HOSE (L380)	1	
28	6A0-82317-00-00	DAMPER, IGNITION COIL	3	
29	624-42542-00-00	PIPE	3	
30	90119-06M65-00	BOLT, WITH WASHER	3	
31	6R3-24323-10-00	PIPE 12	1	
32	90445-12M02-00	HOSE (LONG)	1	
33	6E5-24379-00-00	PIPE, JOINT 4	1	
34	90465-11M10-00	CLAMP	2	
35	6E5-24379-00-00	PIPE, JOINT 4	1	
36	90465-11M10-00	CLAMP	2	
37	90464-13M34-00	CLAMP	1	

Part Notes

P200TLRS 1994 / OIL TANK

PART NUMBER	NOTE TEXT
646-24251-02-00 	OEM: This part number is among the Top 100 Most Popular Marine Maintenance Parts as of August 2013.
92990-06600-00 	OEM: This part number is among the Top 100 Most Popular Marine Maintenance Parts as of August 2013.

©2013 Yamaha Motor Corporation, U.S.A. All rights reserved.

P200TLRS 1994 / FUEL

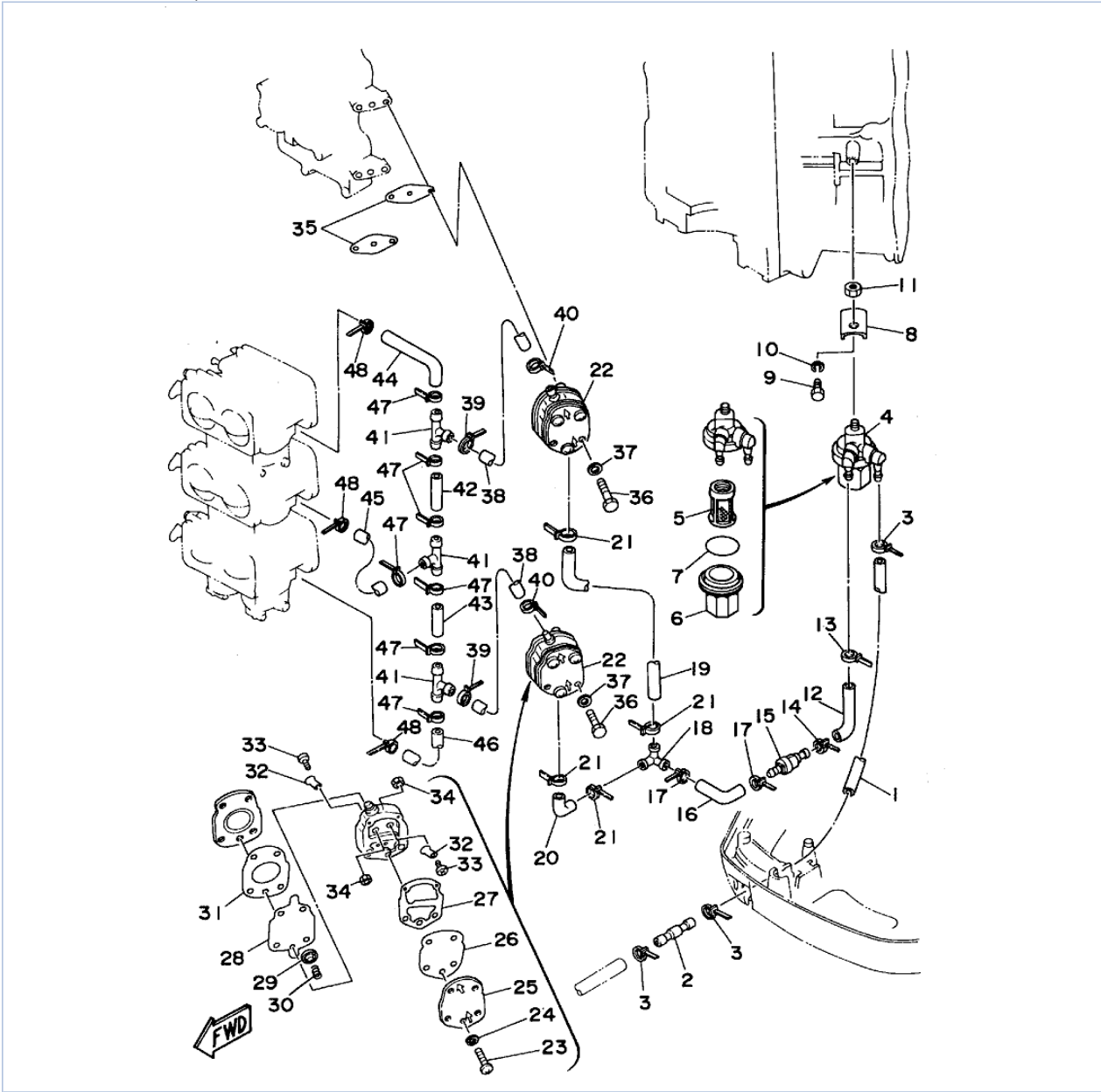

©2013 Yamaha Motor Corporation, U.S.A. All rights reserved.

Part List

P200TLRS 1994 / FUEL

REF - NO	PART NUMBER	PART NAME	QUANTITY	REMARKS
1	6R3-24313-10-00	PIPE 3 (L:1620)	1	
2	6R3-24377-00-00	PIPE, JOINT 2	1	
3	90465-11M10-00	CLAMP	3	
4	6R3-24560-00-00	FILTER ASSY	1	
5	6R3-24563-00-00	.ELEMENT, FILTER	1	
6	61N-24521-00-00	.CUP, FILTER	1	
7	93210-32738-00	.O-RING	1	
8	648-24566-01-00	BRACKET, FILTER	1	
9	97313-06014-00	BOLT, HEXAGON	1	
10	92995-06100-00	WASHER, SPRING	1	
11	95380-08600-00	NUT	1	
12	90445-13M31-00	HOSE (L85)	1	
13	90465-11M10-00	CLAMP	1	
14	90465-11M10-00	CLAMP	1	
15	6R5-24408-00-00	FUEL FEED ASSY	1	
16	6R5-24314-00-00	PIPE 4	1	
17	90465-11M10-00	CLAMP	2	
18	6G5-24376-00-00	PIPE, JOINT 1	1	
19	6K7-24315-00-00	PIPE 5	1	
20	6E5-24315-00-00	PIPE 5	1	
21	90465-11M10-00	CLAMP	4	
22	6E5-24410-03-00	FUEL PUMP ASSY	2	
23	98580-05035-00	.SCREW, PAN HEAD	3	
24	92990-05600-00	.WASHER, PLATE	3	
25	6E5-24413-00-00	.BODY 2	1	
26	6E5-24471-00-00	.DIAPHRAGM	1	
27	6E5-24435-00-00	.GASKET, BODY 2	1	
28	6E5-24411-00-00	.DIAPHRAGM	1	
29	648-24424-00-00	.SEAT, SPRING	1	
30	6E5-24423-00-00	.SPRING, DIAPHRAGM	1	
31	6E5-24434-02-00	.GASKET, BODY	1	
32	6A0-24421-01-00	.VALVE, CHECK	4	
33	6A0-14325-00-00	.SCREW, PAN HEAD	4	
34	95380-03600-00	.NUT	4	
35	650-24431-A0-00	GASKET, FUEL PUMP 1	2	
36	97595-06550-00	BOLT, WITH WASHER	4	
37	92990-06600-00	WASHER, PLATE	4	
38	6G5-24316-10-00	PIPE 6	2	
39	90465-11M10-00	CLAMP	2	
40	90465-11M10-00	CLAMP	2	
41	6E5-24378-00-00	PIPE, JOINT 3	3	
42	90445-13M03-00	HOSE (L50)	1	
43	90445-13M02-00	HOSE (L40)	1	
44	6K7-24317-00-00	PIPE 7	1	
45	6K7-24318-00-00	PIPE, OVERFLOW	1	
46	6K7-24319-00-00	PIPE, OIL	1	
47	90465-11M10-00	CLAMP	7	
48	90465-11M10-00	CLAMP	3	

Part Notes

P200TLRS 1994 / FUEL

PART NUMBER	NOTE TEXT
92995-06100-00	OEM: This part number is among the Top 100 Most Popular Marine Maintenance Parts as of August 2013.

		
6E5-24410-03-00		OEM: This part number is among the Top 100 Most Popular Marine Maintenance Parts as of August 2013.
650-24431-A0-00		OEM: This part number is among the Top 100 Most Popular Marine Maintenance Parts as of August 2013.
92990-06600-00		OEM: This part number is among the Top 100 Most Popular Marine Maintenance Parts as of August 2013.

©2013 Yamaha Motor Corporation, U.S.A. All rights reserved.

P200TLRS 1994 / TOP COWLING

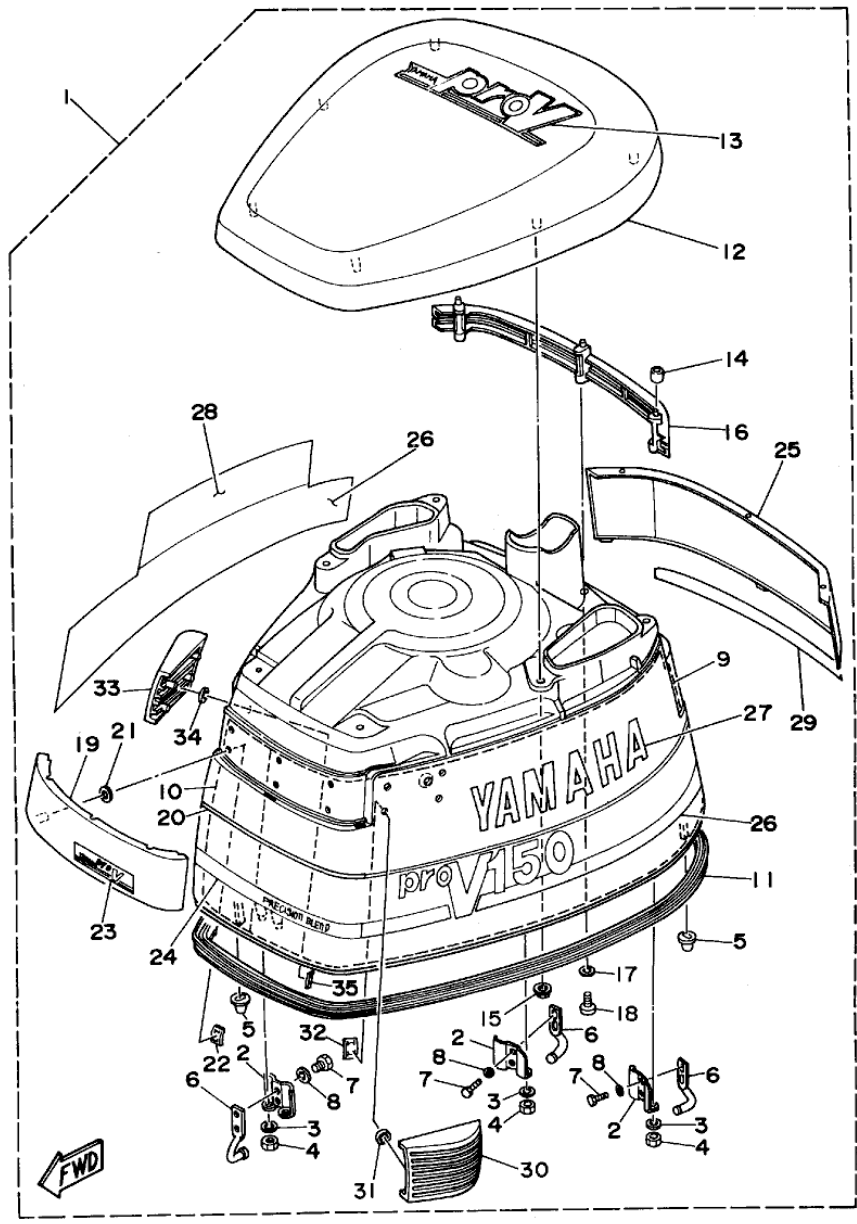

©2013 Yamaha Motor Corporation, U.S.A. All rights reserved.



Part List

P200TLRS 1994 / TOP COWLING

REF - NO	PART NUMBER	PART NAME	QUANTITY	REMARKS
1	6N9-42610-N0-NA	TOP COWLING ASSEMBLY	1	UR P150
1	62H-42610-N0-NA	TOP COWLING ASSEMBLY	1	UR P175
1	61H-42610-N0-NA	TOP COWLING ASSEMBLY	1	UR P200
2	6R3-42647-00-00	.HOLDER, CLAMP BAND	3	
3	92995-06100-00	.WASHER, SPRING	6	
4	95604-06200-00	.NUT, U FLANGE	6	
5	6R3-42662-00-00	.DAMPER	3	
6	6R3-42814-00-00	.HOOK, CLAMP	3	
7	97095-06012-00	.BOLT	6	
8	92990-06600-00	.WASHER, PLATE	6	
9	6N9-42619-00-00	.DAMPER, FORM	1	
10	6N9-42627-00-00	.DAMPER, FORM	1	
11	6R3-42615-01-00	.SEAL	1	
12	6R3-42613-00-4D	.MOLDING, AIR DUCT	1	
13	62A-42683-40-00	.MARK, COWLING	1	
14	90385-04M05-00	.BUSH	3	
15	90179-06M24-00	.NUT	6	
16	6R3-42636-00-00	.LOUVER 2	1	
17	92990-04600-00	.WASHER, PLATE	3	
18	97780-40120-00	.SCREW, TAPPING	3	
19	6N9-42686-00-00	.EMBLEM, FRONT	1	
20	6N9-42684-N0-00	.MARK, COWLING	1	
21	90430-05M06-00	.GASKET	6	
22	90183-05M01-00	.NUT, SPRING	6	
23	61H-42684-N0-00	.MARK, COWLING	1	
24	6N9-42677-N0-00	.GRAPHIC, FRONT	1	
25	6N9-42687-N0-00	.EMBLEM, REAR	1	
26	61H-W0070-N0-00	.GRAPHIC SET	1	UR P200
26	6N9-W0070-N0-00	.GRAPHIC SET	1	UR P150
26	62H-W0070-N0-00	.GRAPHIC SET	1	UR P175
27	6N9-42681-N0-00	.MARK, COWLING	1	
28	6N9-42682-N0-00	.MARK, COWLING	1	
29	6N9-4267A-N0-00	.GRAPHIC, REAR 2	1	
30	6N9-42688-00-00	.EMBLEM, SIDE 1	1	
31	90430-05M06-00	.GASKET	4	
32	90183-05M01-00	.NUT, SPRING	4	
33	6N9-42689-00-00	.EMBLEM, SIDE 2	1	
34	90430-05M06-00	.GASKET	4	
35	90183-05M01-00	.NUT, SPRING	4	

Part Notes

P200TLRS 1994 / TOP COWLING

PART NUMBER	NOTE TEXT
92995-06100-00 	OEM: This part number is among the Top 100 Most Popular Marine Maintenance Parts as of August 2013.
92990-06600-00 	OEM: This part number is among the Top 100 Most Popular Marine Maintenance Parts as of August 2013.

©2013 Yamaha Motor Corporation, U.S.A. All rights reserved.

P200TLRS 1994 / BOTTOM COWLING

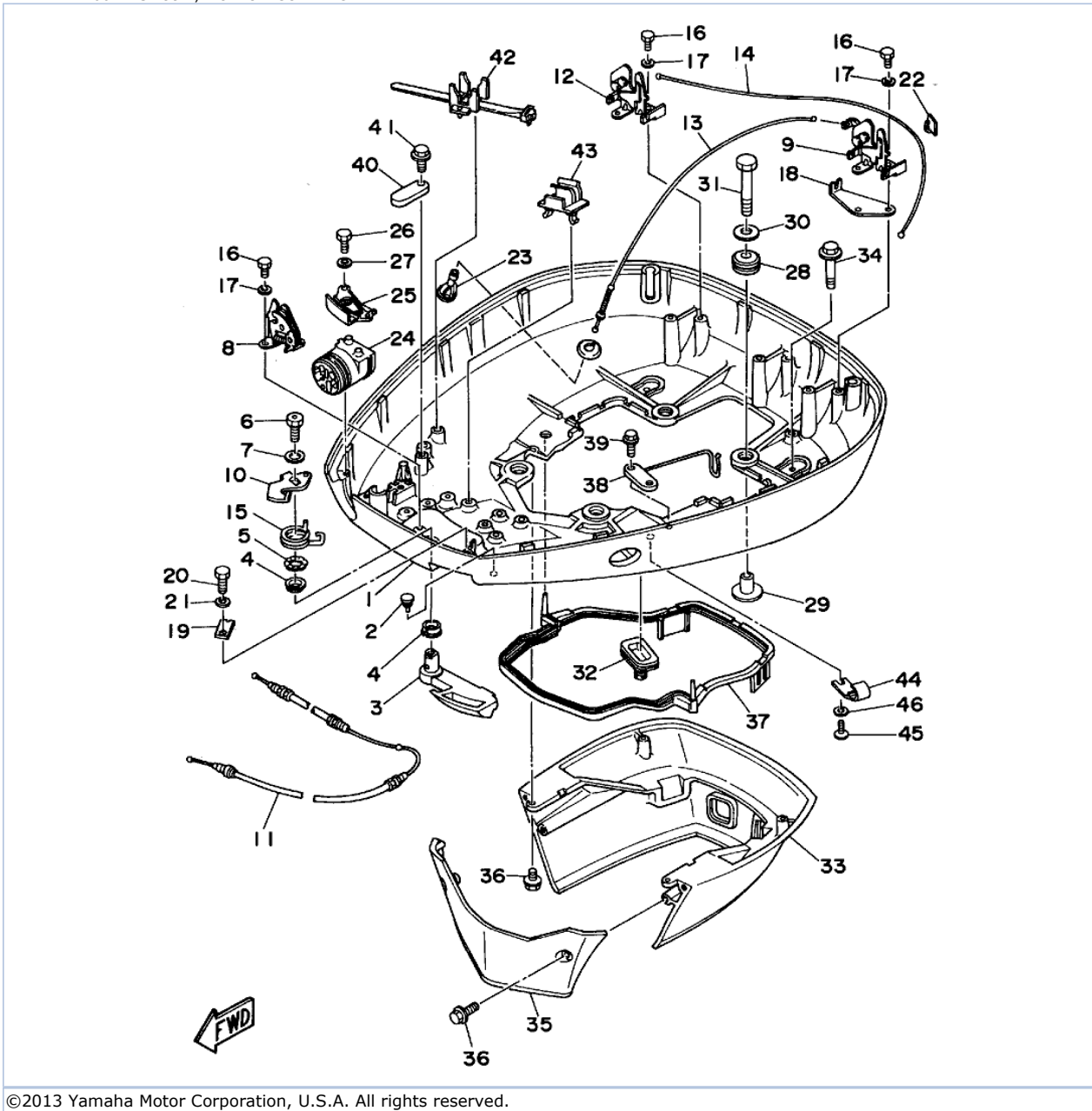

Part List



P200TLRS 1994 / BOTTOM COWLING

REF - NO	PART NUMBER	PART NAME	QUANTITY	REMARKS
1	6R3-42711-41-4D	COWLING, BOTTOM	1	
2	6H4-42748-00-00	GROMMET	1	
3	6R3-42815-00-4D	LEVER, CLAMP	1	
4	90386-13M88-00	BUSH	2	
5	90206-13M10-00	WASHER, WAVE	1	
6	90109-08M45-00	BOLT	1	
7	92990-08200-00	WASHER, PLAIN	1	
8	6R3-42824-00-00	BASE, CLAMP LEVER	1	
9	6R3-42811-01-00	STAY	1	
10	6R3-42816-00-00	LEVER, CLAMP	1	
11	6R3-42850-10-00	WIRE COMPLETE	1	
12	6R3-42811-10-00	STAY	1	
13	6N7-42850-10-00	WIRE COMPLETE	1	
14	6N7-42850-20-00	WIRE COMPLETE	1	
15	6R3-42813-00-00	SPRING, CLAMP LEVER	1	
16	97095-06016-00	BOLT	6	
17	92990-06600-00	WASHER, PLATE	6	
18	6N7-42828-00-00	PLATE, CLAMP	1	
19	6R3-42828-00-00	PLATE, CLAMP	1	
20	97095-06010-00	BOLT	1	
21	92990-06600-00	WASHER, PLATE	1	
22	6N7-42841-00-00	MARK, CLAMP	1	
23	6E5-44391-00-00	NIPPLE, HOSE	1	
24	6R3-42725-20-00	GROMMET	1	
25	6R3-42738-01-5B	PLATE, FITTING	1	
26	97095-06016-00	BOLT	2	
27	92990-06600-00	WASHER, PLATE	2	
28	90480-22M15-00	GROMMET	4	
29	90387-08M37-00	COLLAR	4	
30	90201-08M54-00	WASHER, PLATE	4	
31	97090-08035-00	BOLT	4	
32	688-42726-10-00	GROMMET	1	
33	6R3-42741-00-4D	APRON	1	
34	97595-06520-00	BOLT, WITH WASHER	2	
35	6R3-42771-00-4D	APRON	1	
36	97595-06520-00	BOLT, WITH WASHER	4	
37	6E5-42716-00-00	RUBBER, SEAL 1	1	
38	6K7-82588-00-00	PLATE	1	
39	97595-06520-00	BOLT, WITH WASHER	1	
40	6E5-82588-00-00	PLATE	1	
41	97595-06520-00	BOLT, WITH WASHER	1	
42	688-82594-00-00	CLAMP	1	
43	6E5-82594-00-00	CLAMP	4	
44	6E5-24367-10-00	CLAMP, FUEL PIPE 2	1	
45	90157-06M01-00	SCREW, PAN HEAD	1	
46	92990-06600-00	WASHER, PLATE	1	

Part Notes

P200TLRS 1994 / BOTTOM COWLING

PART NUMBER	NOTE TEXT
92990-06600-00 	OEM: This part number is among the Top 100 Most Popular Marine Maintenance Parts as of August 2013.
92990-06600-00	OEM: This part number is among the Top 100 Most Popular Marine Maintenance Parts as of August 2013.

		
92990-06600-00		OEM: This part number is among the Top 100 Most Popular Marine Maintenance Parts as of August 2013.
92990-06600-00		OEM: This part number is among the Top 100 Most Popular Marine Maintenance Parts as of August 2013.

©2013 Yamaha Motor Corporation, U.S.A. All rights reserved.

P200TLRS 1994 / BRACKET 1

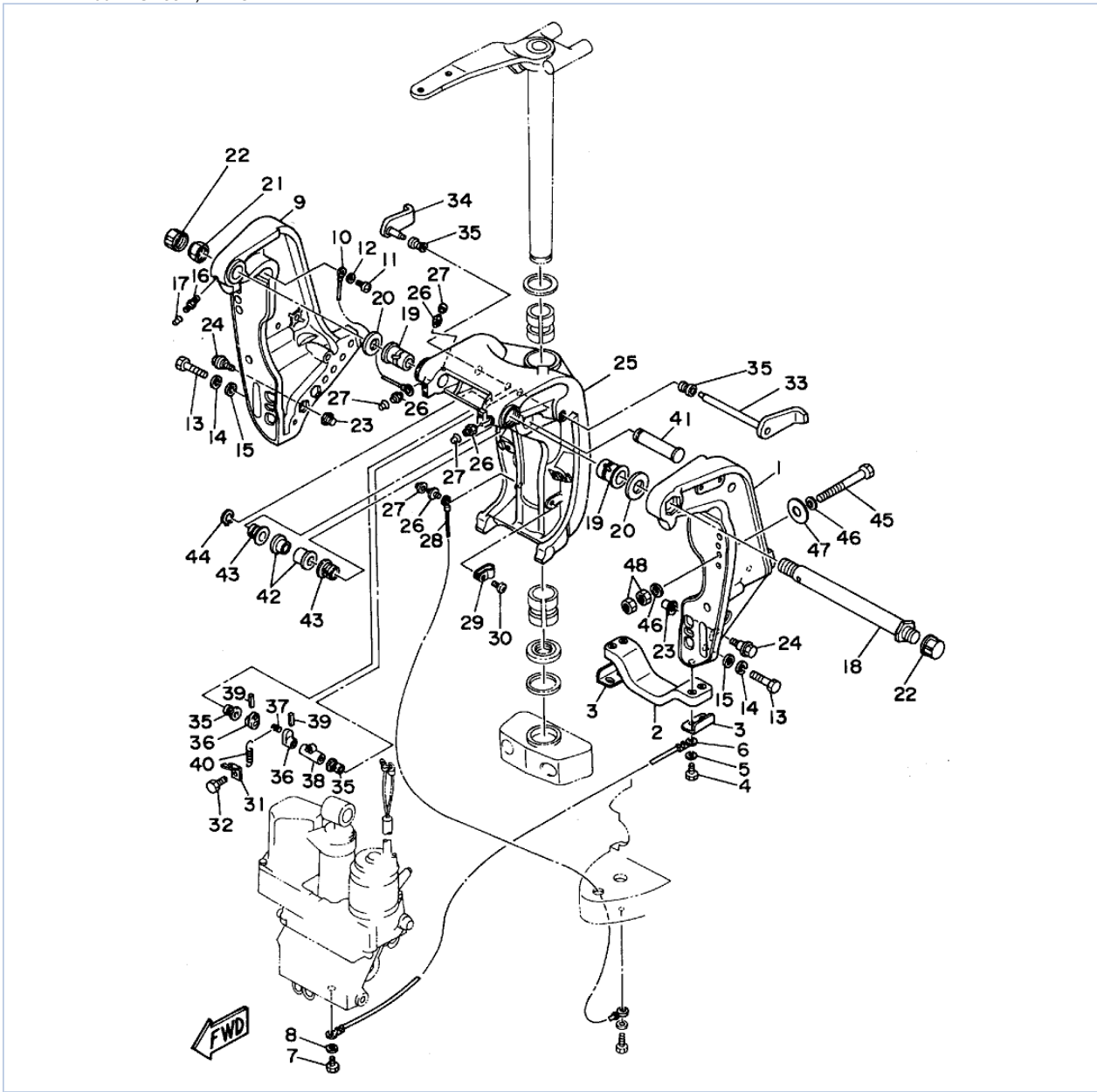

©2013 Yamaha Motor Corporation, U.S.A. All rights reserved.

Part List

P200TLRS 1994 / BRACKET 1

REF - NO	PART NUMBER	PART NAME	QUANTITY	REMARKS
1	6G5-43111-01-4D	BRACKET, CLAMP	1	
2	6G5-45251-01-00	ANODE	1	
3	6G5-44526-00-00	PLATE	2	
4	97095-06030-00	BOLT	4	
5	92995-06100-00	WASHER, SPRING	4	
6	6E5-82148-00-00	WIRE, LEAD 4	1	
7	97095-06010-00	BOLT	1	
8	92990-06600-00	WASHER, PLATE	1	
9	6G5-43112-02-4D	BRACKET, CLAMP	1	
10	6E5-82148-00-00	WIRE, LEAD 4	1	
11	98580-06012-00	SCREW, PAN HEAD	1	
12	92990-06600-00	WASHER, PLATE	1	
13	97395-10050-00	BOLT	6	
14	92990-10100-00	WASHER, SPRING	6	
15	92995-10600-00	WASHER	6	
16	93700-06M03-00	NIPPLE, GREASE	1	
17	663-45119-00-00	CAP, GREASE NIPPLE	1	
18	6R3-43131-00-00	BOLT, CLAMP BRACKET	1	
19	90386-25M31-00	BUSH	2	
20	90201-26M59-00	WASHER, PLATE	2	
21	90185-22M11-00	NUT, SELF-LOCKING	1	
22	6G5-43145-00-00	CAP, CLAMP BRACKET	2	
23	6G5-43164-00-00	ROD, TILT LOCK	2	
24	90109-12M35-00	BOLT	2	
25	6G5-43311-00-4D	BRACKET, SWIVEL	1	
26	93700-06M03-00	NIPPLE, GREASE	5	
27	663-45119-00-00	CAP, GREASE NIPPLE	5	
28	6E5-82147-00-00	WIRE, LEAD 5	1	
29	90464-11M18-00	CLAMP	1	
30	98580-04008-00	.SCREW, PAN HEAD	1	
31	6G5-43144-00-00	HOOK, SPRING	1	
32	97095-06010-00	BOLT	1	
33	6G5-43181-02-00	LEVER, TILT STOP 1	1	
34	6G5-43185-02-00	LEVER, TILT STOP 2	1	
35	90386-10M16-00	BUSH	4	
36	6G5-43148-00-00	COLLAR, DISTANCE	2	
37	90249-06M19-00	PIN	1	
38	90387-10M02-00	COLLAR	1	
39	91690-30020-00	PIN, SPRING	2	
40	90506-14M24-00	SPRING, TENSION	1	
41	6E5-43126-02-00	PIN, UPPER SHOCK MOUNT	1	
42	90386-18M63-00	BUSH	2	
43	90386-18M14-00	BUSH	2	
44	93410-18M02-00	CIRCLIP	1	
45	90101-12M03-00	BOLT (L:115MM)	4	UR
45	90101-12M05-00	BOLT (L:130MM)	4	UR
46	90201-13M01-00	WASHER, PLATE	8	
47	90201-12426-00	WASHER, PLATE	4	
48	95380-12600-00	NUT	8	

Part Notes

P200TLRS 1994 / BRACKET 1

PART NUMBER	NOTE TEXT
-------------	-----------

92995-06100-00		OEM: This part number is among the Top 100 Most Popular Marine Maintenance Parts as of August 2013.
92990-06600-00		OEM: This part number is among the Top 100 Most Popular Marine Maintenance Parts as of August 2013.
92990-06600-00		OEM: This part number is among the Top 100 Most Popular Marine Maintenance Parts as of August 2013.
93700-06M03-00		OEM: This part number is among the Top 100 Most Popular Marine Maintenance Parts as of August 2013.
93700-06M03-00		OEM: This part number is among the Top 100 Most Popular Marine Maintenance Parts as of August 2013.

©2013 Yamaha Motor Corporation, U.S.A. All rights reserved.

P200TLRS 1994 / BRACKET 2

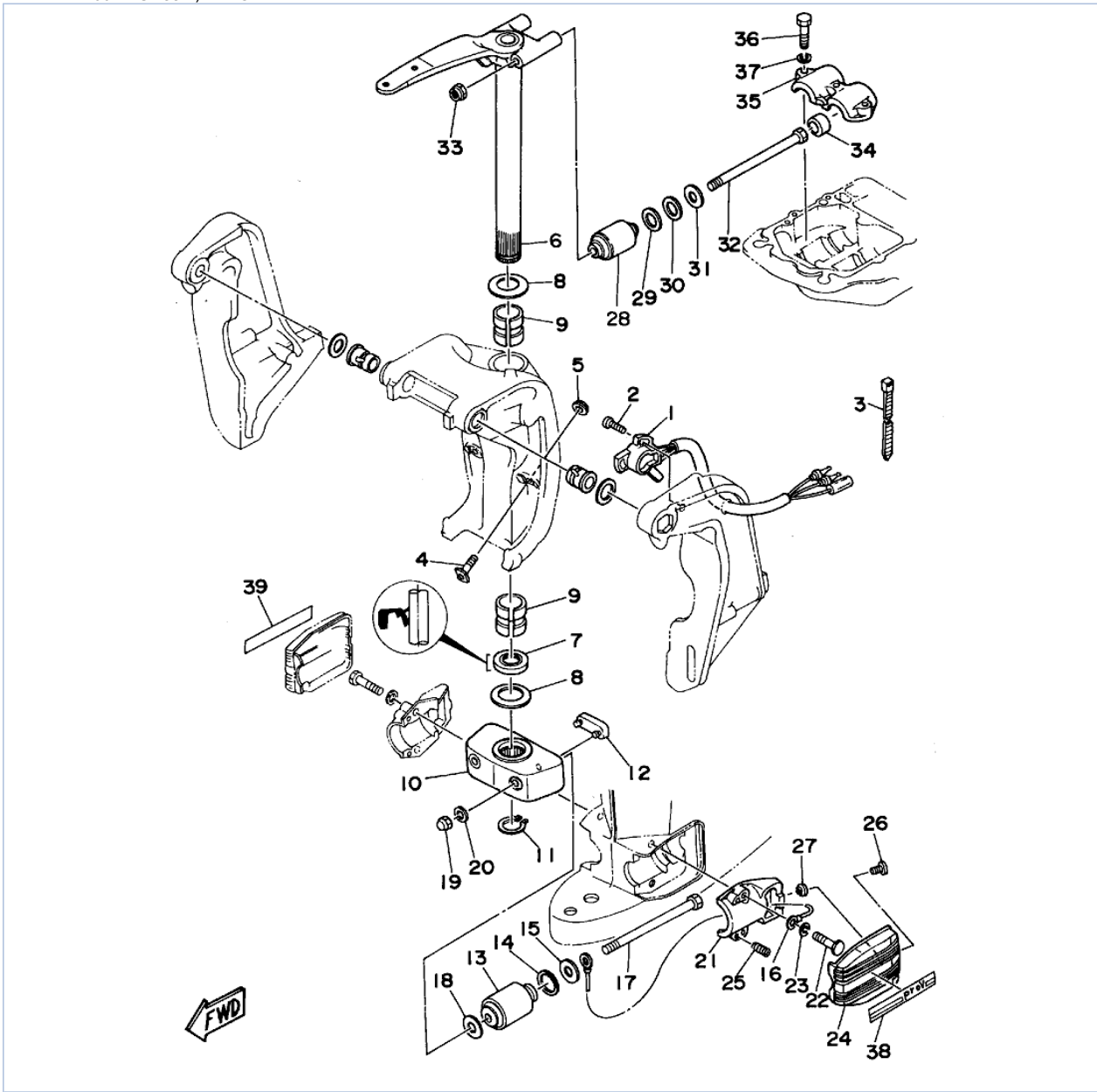

©2013 Yamaha Motor Corporation, U.S.A. All rights reserved.

Part List

P200TLRS 1994 / BRACKET 2

REF - NO	PART NUMBER	PART NAME	QUANTITY	REMARKS
1	6R3-83672-01-00	TRIM SENDER	1	
2	98580-06016-00	SCREW, PAN HEAD	2	
3	90465-11M10-00	CLAMP	3	
4	6G5-43376-00-00	BOLT, THRUST RECEIVER	2	
5	95780-10300-00	NUT, FLANGE	2	
6	6E5-42510-04-4D	STEERING BRACKET ASSEMBLY	1	
7	93109-38M02-00	OIL SEAL	1	
8	90201-38M60-00	WASHER, PLATE	2	
9	90386-38M32-00	BUSH	2	
10	6G5-44551-00-4D	HOUSING, LOWER MOUNT RUBBER	1	
11	93410-37M04-00	CIRCLIP	1	
12	6E5-44575-00-00	DAMPER, LOWER MOUNT RUBBER	1	
13	6J9-44555-00-94	MOUNT DAMPER, LOWER SIDE	2	
14	90202-32M19-00	WASHER, PLATE	2	
15	90201-16M55-00	WASHER, PLATE	2	
16	6E5-82149-00-00	WIRE, LEAD 3	1	
17	90109-14M34-00	BOLT	2	
18	90201-15M58-00	WASHER, PLATE	2	
19	95380-14800-00	NUT	2	
20	92990-14600-00	WASHER	2	
21	6E5-44552-00-94	HOUSING, LOWER MOUNT RUBBER	2	
22	97395-10045-00	BOLT	4	
23	92990-10100-00	WASHER, SPRING	4	
24	6J9-44553-00-NA	COVER, LOWER MOUNT	2	
25	90501-16M28-00	SPRING, COMPRESSION	4	
26	90157-06M05-00	SCREW, PAN HEAD	2	
27	90179-06066-00	NUT	2	
28	6J9-44514-00-94	MOUNT DAMPER, UPPER SIDE	2	
29	90201-26M57-00	WASHER, PLATE	2	
30	90202-26M18-00	WASHER, PLATE	2	
31	90201-14M56-00	WASHER, PLATE	2	
32	90109-12M37-00	BOLT	2	
33	90185-12058-00	NUT, SELF-LOCKING	2	
34	663-44575-00-00	DAMPER, LOWER MOUNT RUBBER	2	
35	6E5-44511-00-5B	COVER, UPPER MOUNT	1	
36	97395-10045-00	BOLT	3	
37	92990-10100-00	WASHER, SPRING	3	
38	6N9-43155-40-00	MARK 1	1	
39	6N9-43156-40-00	MARK 2	1	

P200TLRS 1994 / POWER TRIM TILT ASSEMBLY 1

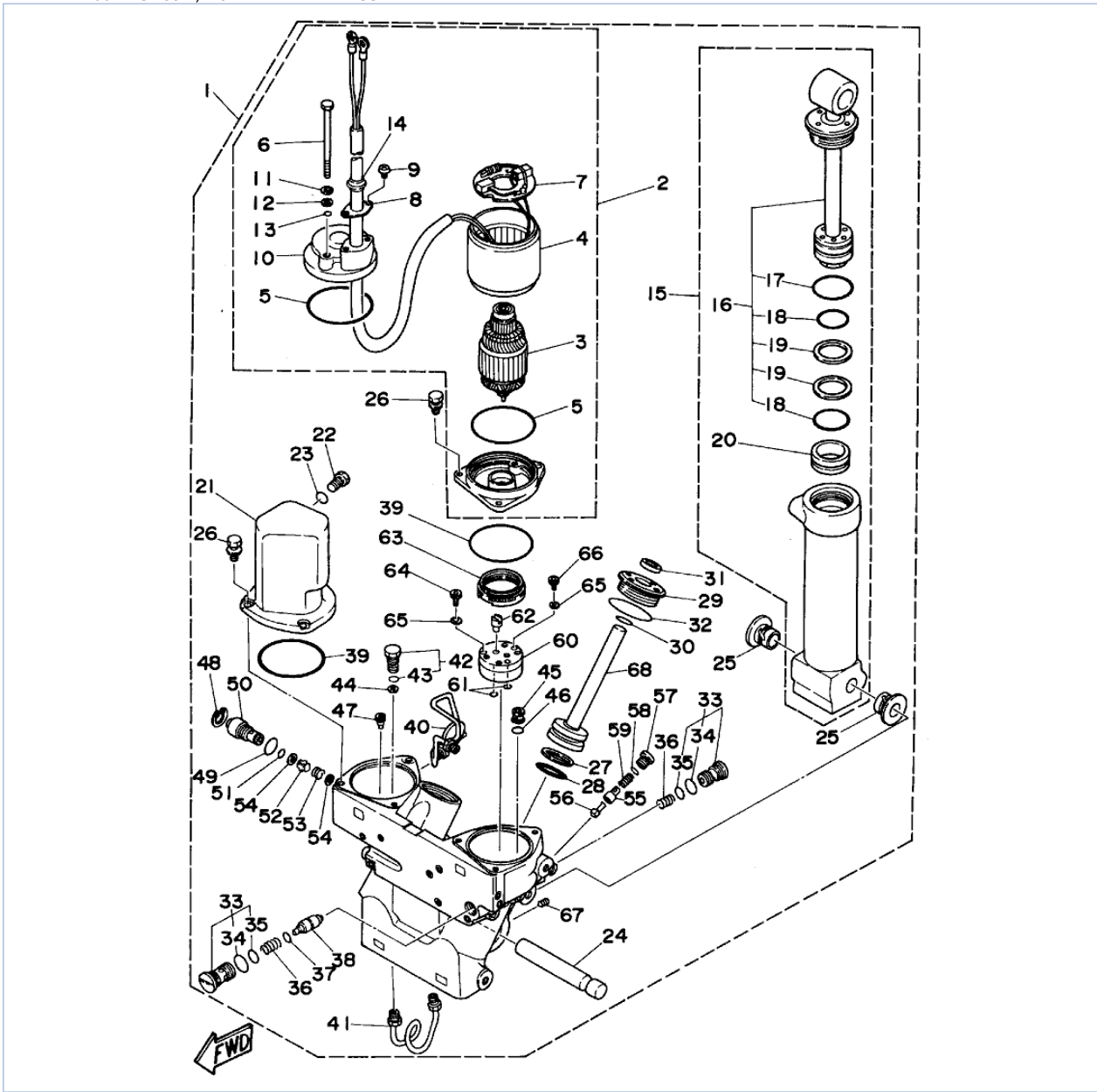

©2013 Yamaha Motor Corporation, U.S.A. All rights reserved.

Part List

P200TLRS 1994 / POWER TRIM TILT ASSEMBLY 1

REF - NO	PART NUMBER	PART NAME	QUANTITY	REMARKS
1	6G5-43800-05-4D	POWER TRIM & TILT ASSEMBLY	1	
2	6G5-43880-02-00	.MOTOR ASSEMBLY	1	
3	6G5-43805-01-00	..ARMATURE ASSEMBLY	1	
4	6G5-43804-00-00	..STATOR ASSY	1	
5	6G5-43865-00-00	..O-RING	2	
6	6G5-43887-00-00	..BOLT, THROUGH	2	
7	6G5-43806-00-00	..BRUSH, HOLDER ASSY	1	
8	6G5-43899-00-00	..PLATE, STOPPER	1	
9	6G5-43886-00-00	..BOLT	2	
10	6G5-43884-00-00	..FRAME, COMMUTATOR END	1	
11	6G5-43893-00-00	..WASHER	2	
12	6G5-43889-10-00	..PLATE SEAT	2	
13	6G5-43867-00-00	..O-RING	2	
14	6G5-43885-00-00	..GROMMET	1	
15	6G5-4380E-01-00	.TILT CYLINDER ASSEMBLY	1	
16	6G5-43810-00-00	..PISTON SUB ASSEMBLY	1	
17	6E5-43861-00-00	..O-RING	1	
18	6G5-43862-00-00	..O-RING	2	
19	6E5-43872-00-00	..RING, BACK UP	2	
20	6E5-43814-02-00	..PISTON, FREE	1	
21	6G5-43828-00-00	.BODY, RESERVOIR	1	
22	6E5-43829-00-00	.PLUG, RESERVOIR	1	
23	6E5-43863-00-00	.O-RING	1	
24	6G5-43818-00-00	.PIN, LOWER SHOCK MOUNT	1	
25	90386-18M14-00	.BUSH	2	
26	90119-06M42-00	.BOLT, WITH WASHER	6	
27	6G5-43874-00-00	.RING, BACK UP	2	
28	6G5-43864-00-00	.O-RING	2	
29	6G5-43821-01-00	.SCREW, TRIM CYLINDER END (6G5-43821-00-00)	2	
30	6E5-43865-00-00	.O-RING	2	
31	6E5-43822-01-00	.SEAL, TRIM DUST	2	
32	6G5-43861-00-00	.O-RING	2	
33	6G5-43802-01-00	.VALVE SUB ASSY	2	
34	6E5-43866-00-00	..O-RING	1	
35	6E5-43867-00-00	..O-RING	1	
36	6G5-43894-00-00	.SPRING, SHUTTLE RETURN	2	
37	6E5-43868-00-00	.O-RING	1	
38	6G5-43841-00-00	.PISTON, SHUTTLE	1	
39	6E5-43869-00-00	.O-RING	2	
40	6G5-43835-00-00	.PIPE	1	
41	6G5-43833-00-00	.PIPE	1	
42	6G5-43809-01-00	.SEAT, VALVE COMP 2	1	
43	6E5-43896-00-00	..O-RING	1	
44	6G5-43816-00-00	.FILTER 1	1	
45	6G5-43808-02-00	.SEAT VALVE COMP 1	1	
46	6E5-43883-00-00	.O-RING	1	
47	6G5-43803-00-00	.CASE VALVE COMP	1	
48	6H1-43875-00-00	.RING, SNAP	1	
49	93210-18M75-00	.O-RING	1	
50	6G5-43845-00-00	.SCREW, MANUAL RELEASE	1	
51	93210-10M74-00	.O-RING	1	
52	6E5-4382A-00-00	.ADAPTER 1	1	

53	6E5-43854-01-00	.SPRING, MANUAL RELEASE	1	
54	6E5-43847-00-00	.SEAT, MANUAL VALVE	2	
55	6G5-43849-00-00	.PIN, VALVE SUPPORT	1	
56	6G5-4381A-00-00	.SHAFT	1	
57	6G5-43842-00-00	.SCREW, VALVE SEAT	1	
58	6G5-43866-00-00	.O-RING	1	
59	6E5-43824-01-00	.SPRING, COMPRESSION	1	
60	6G5-43830-01-00	.GEAR PUMP ASSEMBLY	1	
61	6G5-43863-00-00	.O-RING	2	
62	6G5-43831-01-00	.CONNECTOR, SHAFT	1	
63	6G5-43817-00-00	.FILTER 2	1	
64	6G5-43878-01-00	.BOLT, SOCKET	2	
65	90201-05M00-00	.WASHER, PLATE	3	
66	6G5-43888-01-00	.BOLT, SOCKET	1	
67	6G5-43878-10-00	.BOLT, SOCKET	1	
68	6G5-43820-01-00	.PISTON SUB ASSEMBLY	2	

Part Notes

P200TLRS 1994 / POWER TRIM TILT ASSEMBLY 1

PART NUMBER		NOTE TEXT
6G5-43864-00-00		OEM: This part number is among the Top 100 Most Popular Marine Maintenance Parts as of August 2013.

©2013 Yamaha Motor Corporation, U.S.A. All rights reserved.

P200TLRS 1994 / CONTROL

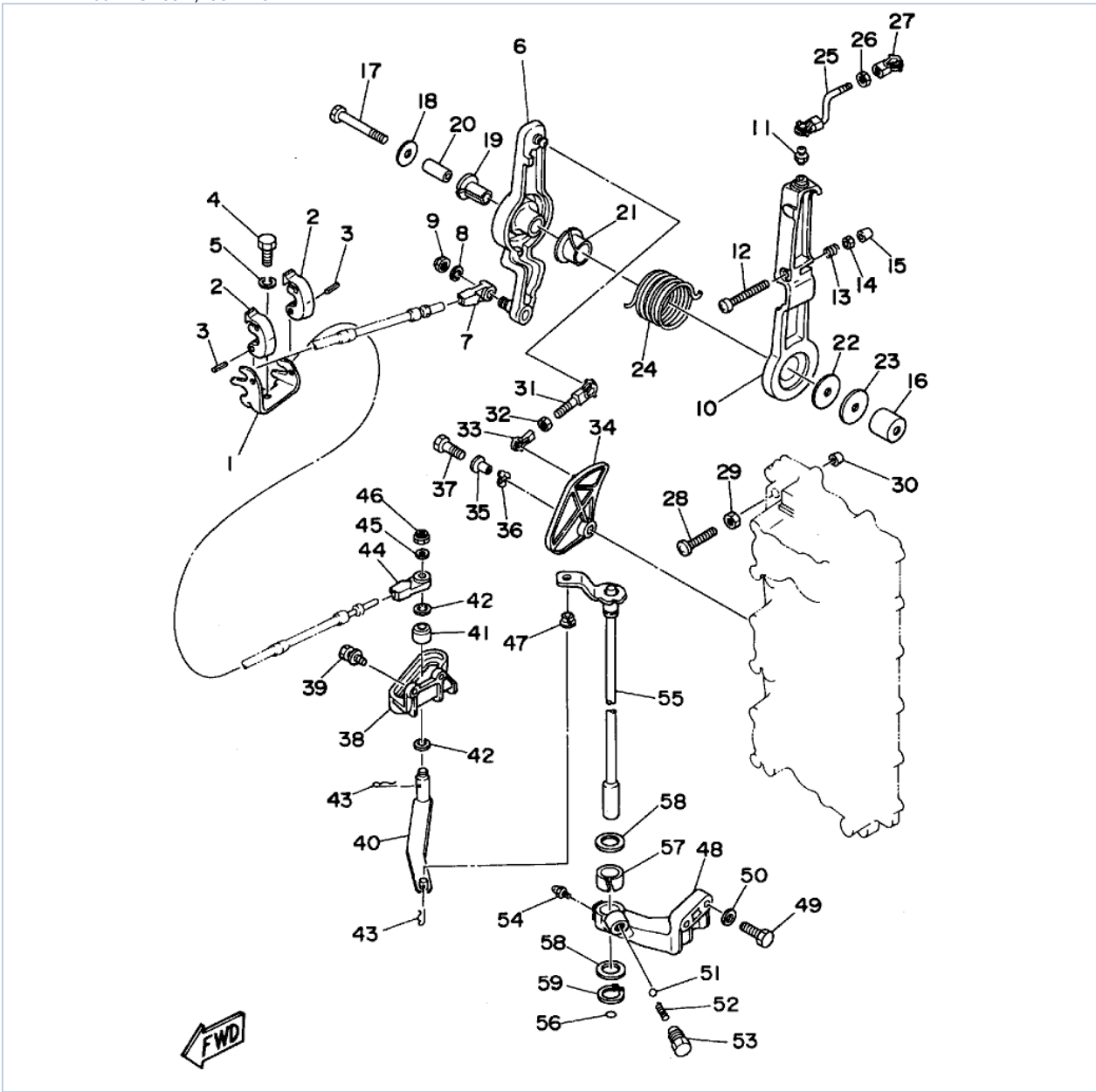

©2013 Yamaha Motor Corporation, U.S.A. All rights reserved.

Part List



P200TLRS 1994 / CONTROL

REF - NO	PART NUMBER	PART NAME	QUANTITY	REMARKS
1	6E5-48531-00-00	BRACKET, REMOTE CONTROL 1	1	
2	6E5-48538-00-00	CLAMP, CABLE	2	
3	91690-30012-00	PIN, SPRING	2	
4	97395-08020-00	BOLT, HEXAGON	1	
5	92995-08100-00	WASHER	1	
6	61H-41632-01-94	LEVER, MAGNETO CONTROL	1	
7	6E5-48344-00-00	CABLE END, REMOTE CONTROL	1	
8	92990-06200-00	..WASHER, PLAIN	1	
9	90185-06M07-00	NUT, SELF-LOCKING	1	
10	6G5-41631-01-94	LEVER, MAGNETO CONTROL	1	
11	663-85518-00-00	JOINT, BALL	1	
12	90157-06M11-00	SCREW, PAN HEAD	1	
13	90501-16M12-00	SPRING, COMPRESSION	1	
14	95604-06200-00	.NUT, U FLANGE	1	
15	688-44194-00-00	CAP	1	
16	90387-08M17-00	COLLAR	1	
17	90101-08M14-00	BOLT	1	
18	90201-08M54-00	WASHER, PLATE	1	
19	90386-12089-00	BUSH	1	
20	90387-08M16-00	COLLAR	1	
21	90386-22M13-00	BUSH	1	
22	90202-12092-00	WASHER, PLATE	1	
23	90201-08M13-00	WASHER, PLATE	1	
24	90508-29M12-00	SPRING, TORSION	1	
25	6G5-41636-01-00	ROD, MAGNETO CONTROL	1	
26	95380-05600-00	NUT	1	
27	6H1-41237-00-00	JOINT, LINK	1	
28	90157-06M07-00	SCREW, PAN HEAD	1	
29	95604-06200-00	.NUT, U FLANGE	1	
30	688-44194-00-00	CAP	1	
31	682-41237-50-00	JOINT, LINK	1	
32	95380-05600-00	NUT	1	
33	6H1-41237-00-00	JOINT, LINK	1	
34	61H-41213-00-00	CAM, ACCEL.	1	
35	90387-06M29-00	COLLAR	1	
36	90206-10M04-00	WASHER, WAVE	1	
37	97095-06025-00	BOLT	1	
38	6E5-44117-00-94	BRACKET	1	
39	97595-06520-00	BOLT, WITH WASHER	2	
40	6E5-44121-00-00	LEVER, SHIFT ROD	1	
41	6E5-44122-00-00	BUSHING, SHIFT ROD LEVER	1	
42	90202-08M20-00	WASHER, PLATE	2	
43	90468-18008-00	CLIP	2	
44	6E5-48344-00-00	CABLE END, REMOTE CONTROL	1	
45	92990-06200-00	..WASHER, PLAIN	1	
46	90185-06M07-00	NUT, SELF-LOCKING	1	
47	90386-06M12-00	BUSH	1	
48	6E5-44118-01-94	BRACKET	1	
49	97313-08030-00	BOLT	2	
50	92990-08600-00	.WASHER, PLATE	2	
51	93501-04M02-00	BALL	1	

52	90501-12082-00	SPRING, COMPRESSION	1	
53	648-42715-00-00	BUSHING	1	
54	93700-06M03-00	NIPPLE, GREASE	1	
55	6E5-44120-03-00	HANDLE GEAR SHIFT ASSY	1	
56	93210-09350-00	O-RING	1	
57	90386-16M66-00	BUSH	1	
58	90202-16061-00	WASHER, PLATE	2	
59	99009-16400-00	CIRCLIP	1	

Part Notes

P200TLRS 1994 / CONTROL

PART NUMBER		NOTE TEXT
6H1-41237-00-00		OEM: This part number is among the Top 100 Most Popular Marine Maintenance Parts as of August 2013.
6H1-41237-00-00		OEM: This part number is among the Top 100 Most Popular Marine Maintenance Parts as of August 2013.
93700-06M03-00		OEM: This part number is among the Top 100 Most Popular Marine Maintenance Parts as of August 2013.

©2013 Yamaha Motor Corporation, U.S.A. All rights reserved.

P200TLRS 1994 / UPPER CASING

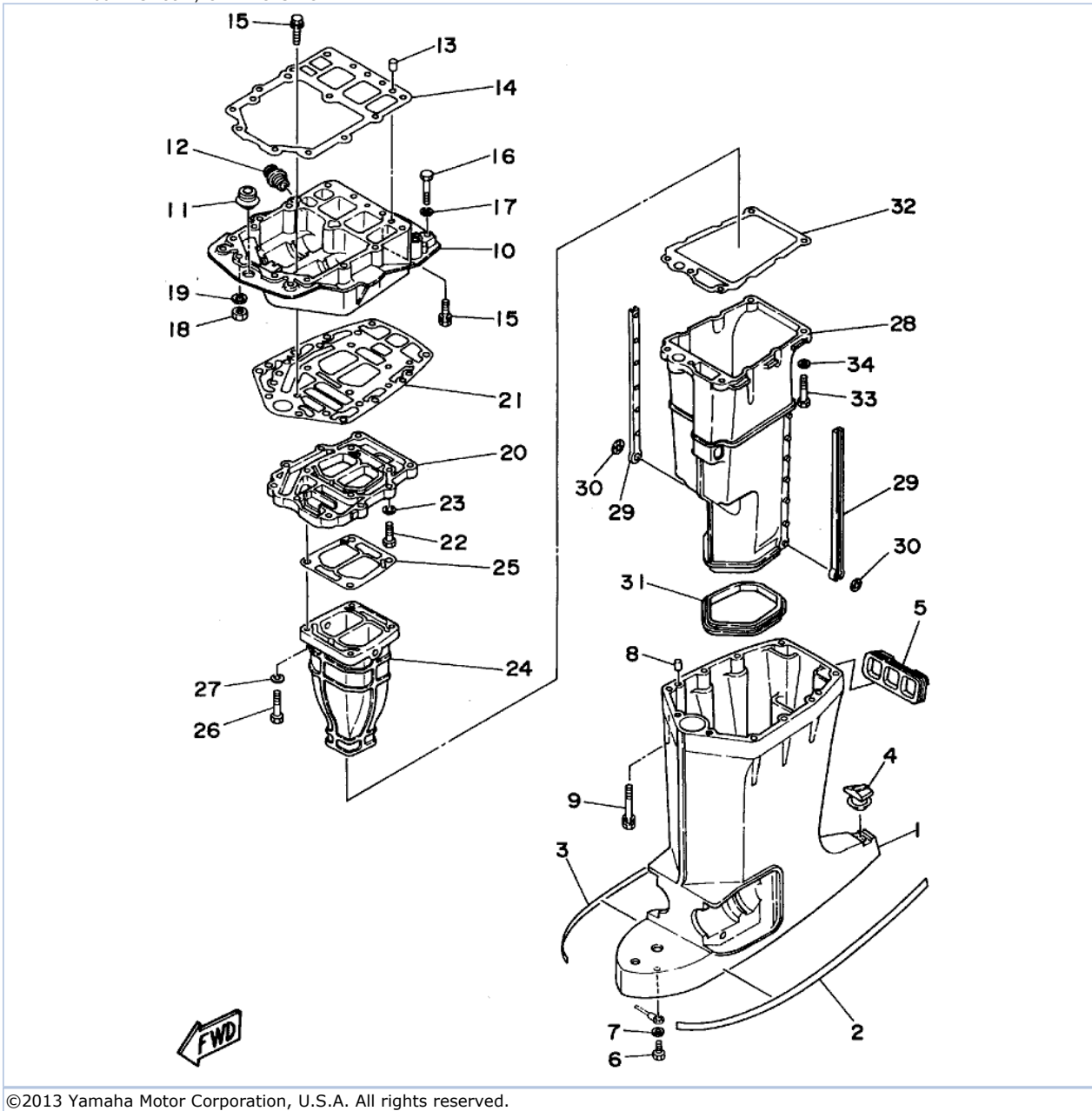

©2013 Yamaha Motor Corporation, U.S.A. All rights reserved.

Part List

P200TLRS 1994 / UPPER CASING

REF - NO	PART NUMBER	PART NAME	QUANTITY	REMARKS
1	6E5-45111-00-4D	CASING, UPPER	1	
2	6N9-42791-40-00	MARK 1	1	
3	6N9-42792-40-00	MARK 2	1	
4	6E5-45155-00-00	CAP	1	
5	6E5-42769-00-00	SEAL, RUBBER	1	
6	97095-06010-00	BOLT	1	
7	92990-06600-00	WASHER, PLATE	1	
8	93608-12M05-00	PIN, DOWEL	2	
9	90119-08M78-00	BOLT, WITH WASHER	6	
10	6G5-41137-00-94	GUIDE, EXHAUST	1	
11	6E5-42724-00-00	GROMMET	1	
12	6G5-12581-00-00	JOINT, HOSE 1	1	
13	93608-12M05-00	PIN, DOWEL	2	
14	6G5-45113-A0-00	GASKET, UPPER CASING	1	
15	90119-08M79-00	BOLT, WITH WASHER	6	
16	97395-08045-00	BOLT	2	
17	92995-08100-00	WASHER	2	
18	95380-08700-00	NUT	2	
19	92990-08100-00	WASHER, SPRING	2	
20	6G5-41131-00-5B	MANIFOLD, EXHAUST 1 (6G5-41131-00-9M)	1	
21	6G5-45114-A0-00	GASKET, UPPER CASING	1	
22	97395-08030-00	BOLT	4	
23	92995-08600-00	WASHER	4	
24	6J9-41132-00-5B	MANIFOLD, EXHAUST	1	UR P200
24	6G5-41132-00-5B	MANIFOLD, EXHAUST (6G5- 41132-00-9M)	1	UR P150/175
25	6G5-41134-A0-00	.GASKET, EXHAUST MANIFOLD	1	
26	97395-08045-00	BOLT	4	
27	92995-08600-00	WASHER	4	
28	6E5-14711-00-5B	MUFFLER 1 (6E5-14711-00- 9M)	1	
29	6E5-14737-00-00	DAMPER, MUFFLER	2	
30	90183-05M02-00	NUT, SPRING	2	
31	6E5-45123-00-00	.GASKET, MUFFLER	1	
32	6E5-41135-A0-00	.GASKET, EXHAUST MANIFOLD	1	
33	97395-08045-00	BOLT	5	
34	92995-08600-00	WASHER	5	

Part Notes

P200TLRS 1994 / UPPER CASING

PART NUMBER	NOTE TEXT
92990-06600-00 	OEM: This part number is among the Top 100 Most Popular Marine Maintenance Parts as of August 2013.

©2013 Yamaha Motor Corporation, U.S.A. All rights reserved.

P200TLRS 1994 / LOWER CASING DRIVE 1

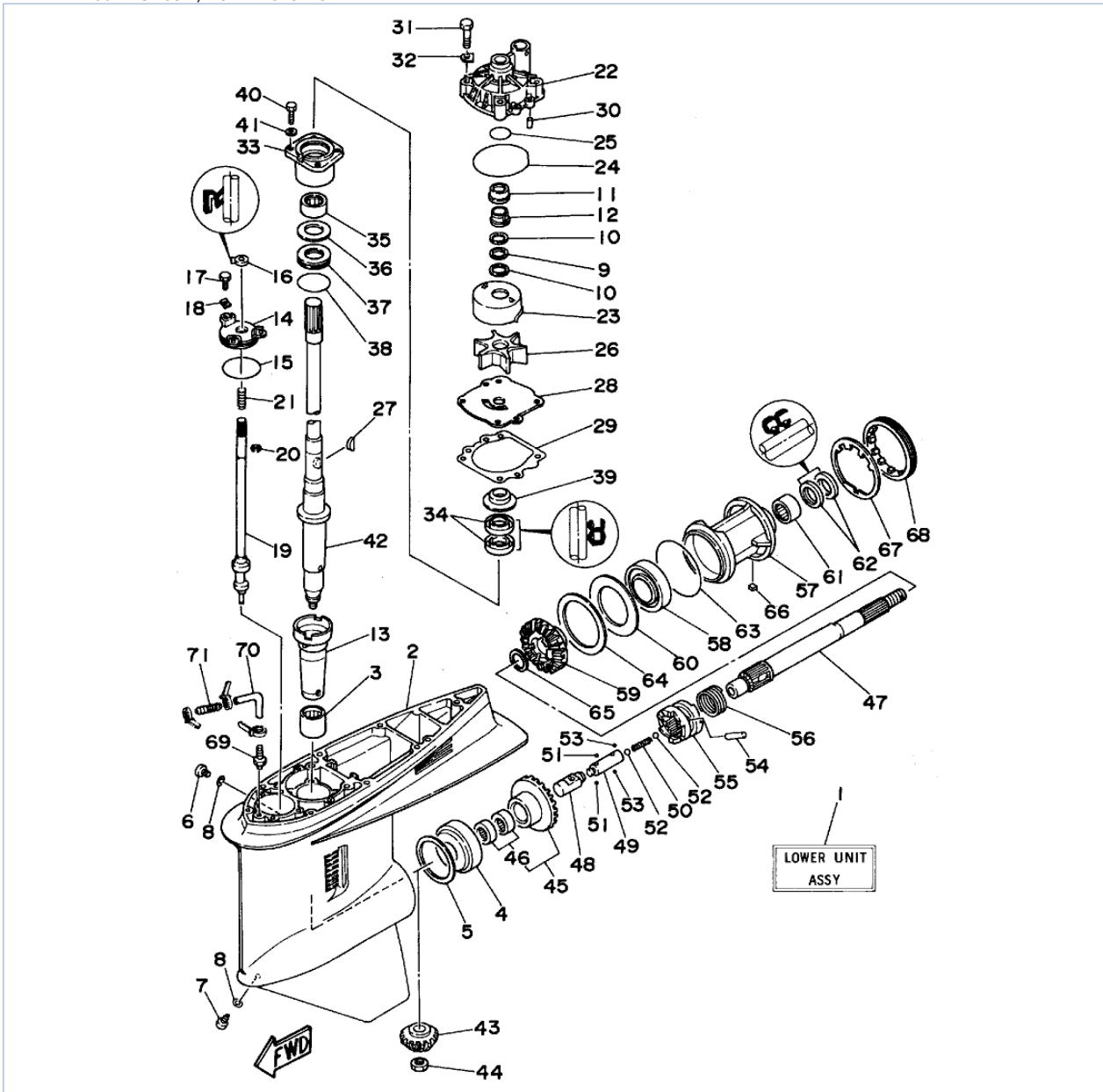

©2013 Yamaha Motor Corporation, U.S.A. All rights reserved.

Part List





P200TLRS 1994 / LOWER CASING DRIVE 1

REF - NO	PART NUMBER	PART NAME	QUANTITY	REMARKS
1	6J9-45300-14-NA	LOWER UNIT ASSEMBLY (REF. #2~71)	1	UR P150
1	6G5-45300-14-NA	LOWER UNIT ASSEMBLY (REF. #2~71)	1	UR P175
1	61H-45300-12-NA	LOWER UNIT ASSEMBLY (REF. #2~71)	1	UR P200
2	6J9-45301-01-NA	CASING, LOWER	1	
3	93311-928U5-00	BEARING	1	
4	93332-000V3-00	BEARING	1	
5	6G5-45567-01-12	SHIM (T:0.12MM)	1	UR
5	6G5-45567-01-30	SHIM (T:0.30MM)	1	UR
5	6G5-45567-01-40	SHIM (T:0.40MM)	1	UR
5	6G5-45567-01-18	SHIM (T:0.18MM)	1	UR
5	6G5-45567-01-50	SHIM (T:0.50MM)	1	UR
5	6G5-45567-01-10	SHIM (T:0.10MM)	1	UR
5	6G5-45567-01-15	SHIM (T:0.15MM)	1	UR
6	90340-08M04-00	PLUG, STRAIGHT SCREW	1	
7	688-45341-00-00	PLUG, DRAIN	1	
8	90430-08020-00	.GASKET	2	
9	90206-22M19-00	WASHER, WAVE	1	
10	90201-22M01-00	WASHER, PLATE	2	
11	61A-45527-00-00	COLLAR, DRIVE SHAFT	1	
12	61A-45538-00-00	SPACER 1	1	
13	6G5-45536-01-00	SLEEVE, DRIVE SHAFT	1	
14	6E5-45321-00-00	PLATE	1	
15	93210-58677-00	O-RING	1	
16	93106-09014-00	.OIL SEAL	1	
17	97095-06020-00	BOLT	3	
18	90209-06M04-00	WASHER	3	
19	6G5-44150-01-00	SHIFT CAM ASSY	1	
20	99001-08600-00	CIRCLIP	1	
21	90501-11M10-00	SPRING, COMPRESSION	1	
22	61A-44311-00-00	HOUSING, WATER PUMP	1	
23	61A-44322-00-00	INSERT, CARTRIDGE	1	
24	93210-86M38-00	.O-RING	1	
25	93210-37M67-00	O-RING	1	
26	6E5-44352-00-00	IMPELLER	1	
27	90280-04M05-00	.KEY, WOODRUFF	1	
28	6G5-44323-00-00	.OUTER PLATE, CARTRIDGE	1	
29	6E5-44315-A0-00	.GASKET, WATER PUMP	1	
30	93606-12019-00	.PIN, DOWEL	2	
31	97395-08045-00	BOLT	4	
32	90209-08M02-00	WASHER	4	
33	6E5-45331-00-94	HOUSING, BEARING	1	
34	93101-28M16-00	.OIL SEAL	2	
35	93317-330U2-00	BEARING	1	
36	6E5-45587-01-12	SHIM (T:0.12MM)	1	UR
36	6E5-45587-01-30	SHIM (T:0.30MM)	1	UR
36	6E5-45587-01-50	SHIM (T:0.50MM)	1	UR
36	6E5-45587-01-10	SHIM (T:0.10MM)	1	UR
36	6E5-45587-01-15	SHIM (T:0.15MM)	1	UR
36	6E5-45587-01-18	SHIM (T:0.18MM)	1	UR
36	6E5-45587-01-40	SHIM (T:0.40MM)	1	UR
37	93341-930U0-00	BEARING, THRUST	1	

38	93210-54534-00	O-RING	1	
39	6E5-45344-00-00	COVER, OIL SEAL	1	
40	97395-08025-00	BOLT	4	
41	92995-08600-00	WASHER	4	
42	6G5-45501-01-00	DRIVE SHAFT COMP.	1	
43	6G5-45551-01-00	PINION (14T)	1	UR P175
43	61H-45551-00-00	PINION (14T)	1	UR P200
43	6J9-45551-01-00	PINION (14T)	1	UR P150
44	90170-16M01-00	NUT	1	
45	6G5-45560-01-00	GEAR 1 (26T)	1	UR P175
45	61H-45560-00-00	GEAR 1 (26T)	1	UR P200
45	6J9-45560-02-00	GEAR	1	UR P150
46	93315-425V3-00	.BEARING	2	
47	6J9-45611-01-00	SHAFT, PROPELLER	1	
48	6E5-45641-01-00	SHIFTER	1	
49	6E5-45634-01-00	SLIDE, SHIFT	1	
50	90501-16M37-00	SPRING, COMPRESSION	1	
51	93507-32031-00	BALL 7-32	2	
52	93511-32027-00	BALL	2	
53	93503-16010-00	BALL 3-16	2	
54	90250-08M07-00	PIN, STRAIGHT	1	
55	6G5-45631-00-00	CLUTCH, DOG	1	
56	6E5-45633-01-00	RING, CROSS PIN	1	
57	6J9-45332-00-94	HOUSING, BEARING	1	
58	93306-209U0-00	BEARING	1	
59	6G5-45571-02-00	GEAR 2 (26T)	1	UR P175
59	6J9-45571-02-00	GEAR 2 (28T)	1	UR P150
59	61H-45571-01-00	GEAR 2 (26T)	1	UR P200
60	6G5-45576-00-00	WASHER, THRUST	1	
61	93315-430U8-00	BEARING	1	
62	93101-30M17-00	.OIL SEAL	2	
63	93210-97M55-00	.O-RING	1	
64	6G5-45577-02-12	SHIM (T:0.12MM)	1	UR
64	6G5-45577-02-30	SHIM (T:0.30MM)	1	UR
64	6G5-45577-02-50	SHIM (T:0.50MM)	1	UR
64	6G5-45577-02-10	SHIM (T:0.10MM)	1	UR
64	6G5-45577-02-15	SHIM (T:0.15MM)	1	UR
64	6G5-45577-02-18	SHIM (T:0.18MM)	1	UR
64	6G5-45577-02-40	SHIM (T:0.40MM)	1	UR
65	90201-30M92-00	WASHER, PLATE	1	
66	90282-04M00-00	KEY, STRAIGHT	1	
67	6G5-45383-01-00	WASHER, CLAW	1	
68	6G5-45384-00-00	NUT	1	
69	6E5-45378-00-00	NIPPLE, HOSE	1	
70	90445-07ME8-00	HOSE (L80)	1	
71	6E5-83558-10-00	END, NIPPLE	1	

Part Notes

P200TLRS 1994 / LOWER CASING DRIVE 1

PART NUMBER		NOTE TEXT
90430-08020-00		OEM: This part number is among the Top 100 Most Popular Marine Maintenance Parts as of August 2013.
90201-22M01-00		OEM: This part number is among the Top 100 Most Popular Marine Maintenance Parts as of August 2013.
61A-45527-00-00		OEM: This part number is among the Top 100 Most Popular Marine Maintenance Parts as of August 2013.
61A-45538-00-00		OEM: This part number is among the Top 100 Most Popular Marine Maintenance Parts as of August 2013.
93106-09014-00		OEM: This part number is among the Top 100 Most Popular Marine Maintenance Parts as of August 2013.

93210-86M38-00		OEM: This part number is among the Top 100 Most Popular Marine Maintenance Parts as of August 2013.
93101-28M16-00		OEM: This part number is among the Top 100 Most Popular Marine Maintenance Parts as of August 2013.
93210-54534-00		OEM: This part number is among the Top 100 Most Popular Marine Maintenance Parts as of August 2013.
93101-30M17-00		OEM: This part number is among the Top 100 Most Popular Marine Maintenance Parts as of August 2013.

©2013 Yamaha Motor Corporation, U.S.A. All rights reserved.

P200TLRS 1994 / LOWER CASING DRIVE 2

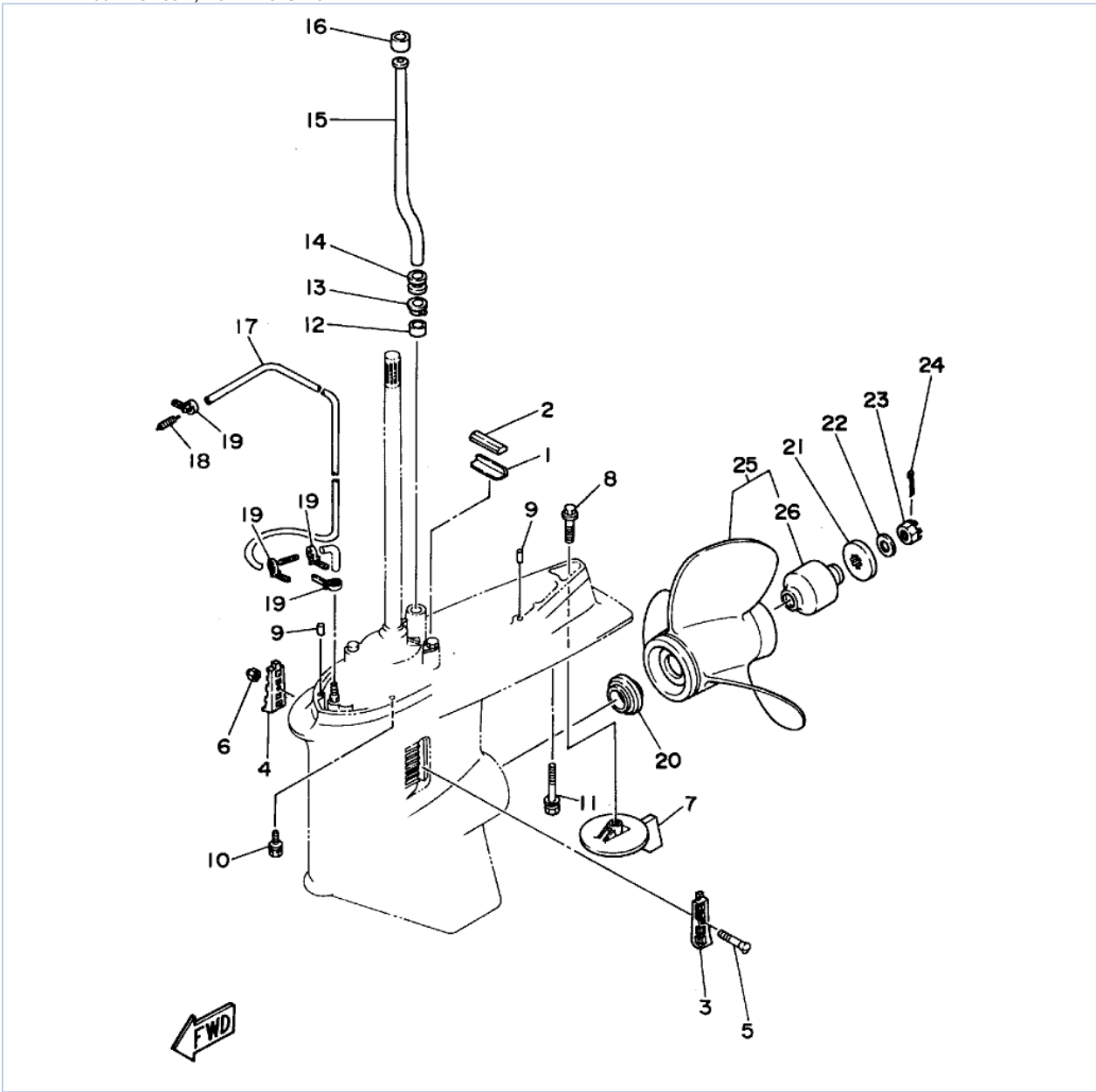

©2013 Yamaha Motor Corporation, U.S.A. All rights reserved.



Part List

P200TLRS 1994 / LOWER CASING DRIVE 2

REF - NO	PART NUMBER	PART NAME	QUANTITY	REMARKS
1	663-45376-00-94	GUIDE, SEAL DAMPER	1	SEE NOTE
2	688-45375-00-00	DAMPER, SEAL	1	SEE NOTE
3	6J9-45214-00-00	COVER, WATER INLET 1	1	
4	6J9-45215-00-00	COVER, WATER INLET 2	1	
5	90142-05M04-00	SCREW	1	
6	90185-05002-00	NUT, NYLON	1	
7	6J9-45371-01-00	TAB-TRIM	1	
8	90105-10M00-00	BOLT, FLANGE	1	
9	93608-12M05-00	PIN, DOWEL	2	
10	90101-10M70-00	BOLT	6	
11	90119-10M89-00	BOLT, WITH WASHER	1	
12	6E5-44365-00-00	DAMPER, WATER SEAL 1	1	SEE NOTE
13	6E5-44312-00-00	COVER, WATER PUMP HOUSING	1	SEE NOTE
14	6E5-44366-00-00	DAMPER, WATER SEAL 2	1	
15	6E5-44361-00-00	TUBE, WATER 1	1	
16	6E5-44365-00-00	DAMPER, WATER SEAL 1	1	
17	90445-07MF0-00	HOSE (L1030)	1	
18	6E5-83558-00-00	END, NIPPLE	1	
19	90465-11M10-00	CLAMP	4	
20	6E5-45987-01-00	SPACER 1	1	
21	688-45997-01-00	SPACER 2	1	
22	92990-18200-00	WASHER	1	
23	90171-18M04-00	NUT, CASTLE	1	
24	91490-40030-00	PIN. COTTER	1	
25	6J9-45972-02-00	PROPELLER (3X14-1/2"X23"-M)	1	UR
25	6J9-45970-02-00	PROPELLER (3X14-1/2"X25"-M)	1	UR
25	6J9-45976-00-00	PROPELLER (3X14-1/2"X21"-M)	1	UR
25	6J9-45974-01-00	PROPELLER (3X14-1/2"X27"-M)	1	UR
26	6G5-45981-00-00	.DAMPER RUBBER, PROPELLER	1	

Part Notes

P200TLRS 1994 / LOWER CASING DRIVE 2

PART NUMBER		NOTE TEXT
6J9-45371-01-00		OEM: This part number is among the Top 100 Most Popular Marine Maintenance Parts as of August 2013.
90105-10M00-00		OEM: This part number is among the Top 100 Most Popular Marine Maintenance Parts as of August 2013.
91490-40030-00		OEM: This part number is among the Top 100 Most Popular Marine Maintenance Parts as of August 2013.

©2013 Yamaha Motor Corporation, U.S.A. All rights reserved.

P200TLRS 1994 / GENERATOR

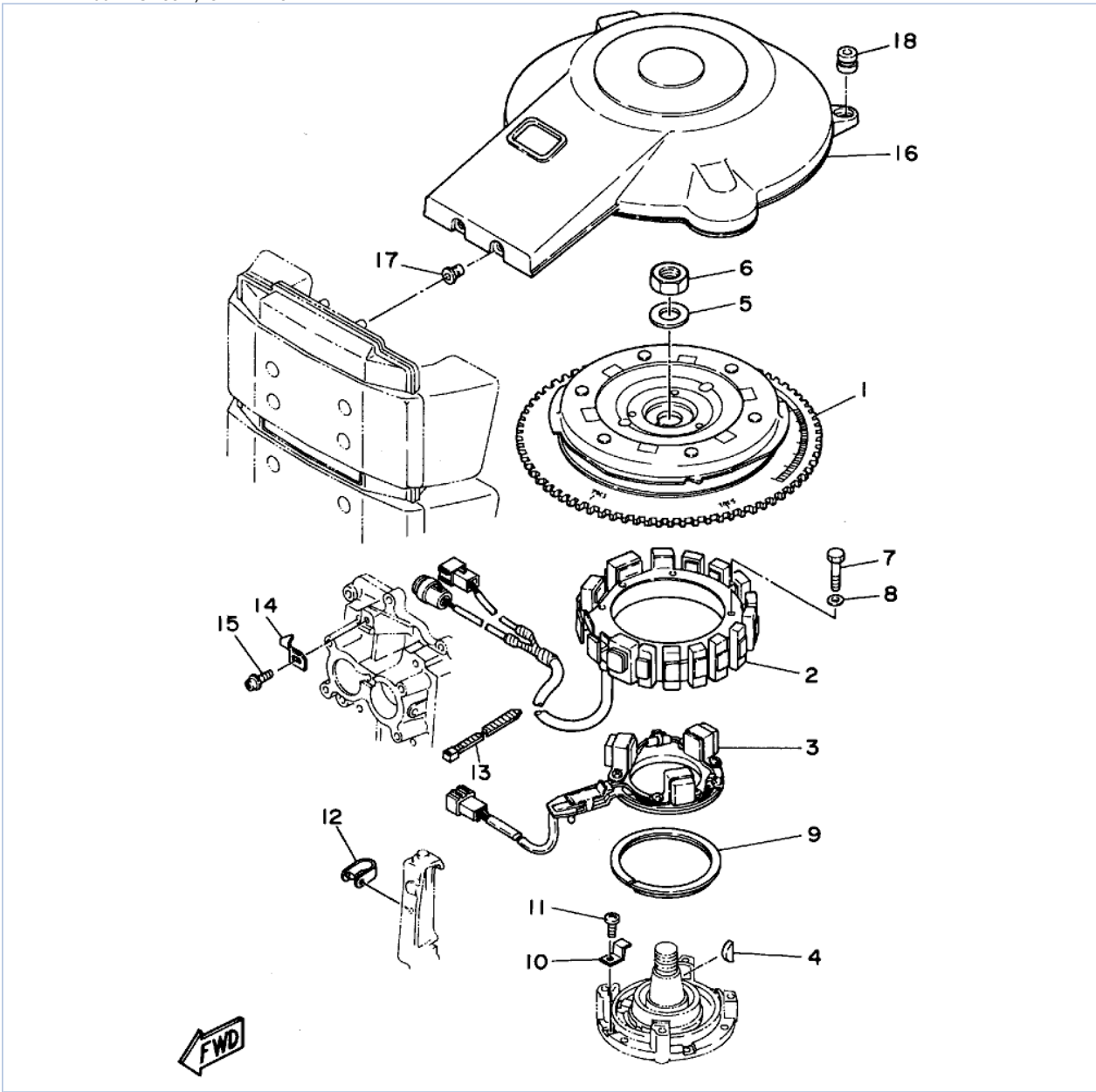

©2013 Yamaha Motor Corporation, U.S.A. All rights reserved.

Part List

P200TLRS 1994 / GENERATOR

REF - NO	PART NUMBER	PART NAME	QUANTITY	REMARKS
1	6R3-85550-00-00	ROTOR ASSEMBLY	1	
2	6R3-85510-00-00	STATOR ASSY	1	
3	6R3-85580-00-00	COIL, PULSER	1	
4	90280-05049-00	KEY, WOODRUFF	1	
5	90201-21M18-00	WASHER, PLATE	1	
6	90170-20137-00	NUT	1	
7	97313-06070-00	NUT (97301-06070)	4	
8	92990-06600-00	WASHER, PLATE	4	
9	688-41611-00-00	RETAINER, MAGNETO BASE	1	
10	688-41612-00-00	RETAINER, MAGNETO BASE	4	
11	97880-06018-00	SCREW, PAN HEAD	4	
12	90464-12M00-00	CLAMP	1	
13	90465-11M10-00	CLAMP	1	
14	6E5-81332-00-00	PLATE, TIMING	1	
15	97985-06210-00	SCREW, WITH WASHER	1	
16	6R3-81337-00-00	COVER, FLYWHEEL	1	
17	6G5-82317-00-00	DAMPER, IGNITION COIL	2	
18	663-82317-01-00	DAMPER, IGNITION COIL	2	

Part Notes

P200TLRS 1994 / GENERATOR

PART NUMBER	NOTE TEXT
92990-06600-00 	OEM: This part number is among the Top 100 Most Popular Marine Maintenance Parts as of August 2013.

©2013 Yamaha Motor Corporation, U.S.A. All rights reserved.

P200TLRS 1994 / STARTING MOTOR 1 (P150 P175)

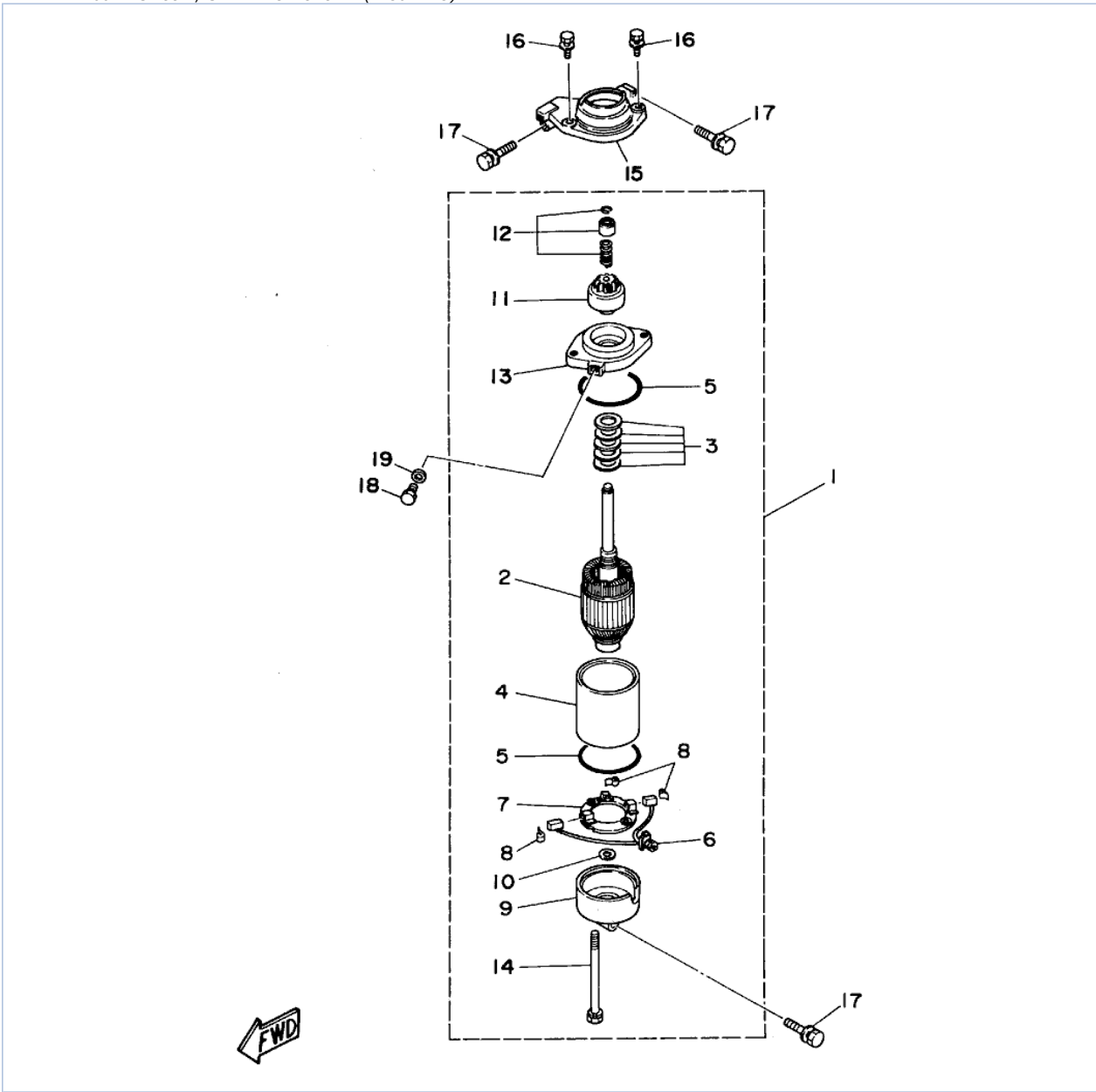

©2013 Yamaha Motor Corporation, U.S.A. All rights reserved.

Part List

P200TLRS 1994 / STARTING MOTOR 1 (P150 P175)

REF - NO	PART NUMBER	PART NAME	QUANTITY	REMARKS
1	6E5-81800-12-00	STARTER MOTOR ASSY	1	
2	6E5-81850-11-00	.ARMATURE ASSY	1	
3	6E5-81809-10-00	.WASHER KIT	1	
4	6E5-81810-10-00	.STATOR ASSY	1	
5	6E5-81847-10-00	.O-RING	2	
6	6E5-81801-10-00	.BRUSH SET	1	
7	6E5-81840-10-00	.BRUSH HOLDER ASSY	1	
8	6E5-81813-10-00	.SPRING, BRUSH	3	
9	6E5-81820-11-00	.REAR BRACKET ASSY	1	
10	6E5-81824-00-00	.WASHER 2	1	
11	6E5-81807-11-00	.GEAR ASSY, STARTING MOTOR	1	
12	61H-81857-00-00	.RETAINER	1	
13	6E5-81830-10-00	.FRONT BRACKET ASSY	1	
14	6E5-81826-10-00	.BOLT	2	
15	6K7-81822-00-94	BRACKET, STARTING MOTOR	1	
16	90119-08M76-00	BOLT, WITH WASHER	2	
17	90119-08M77-00	BOLT, WITH WASHER	3	
18	97095-08016-00	BOLT	1	
19	92995-08600-00	WASHER	1	

P200TLRS 1994 / STARTING MOTOR 2 (P200)

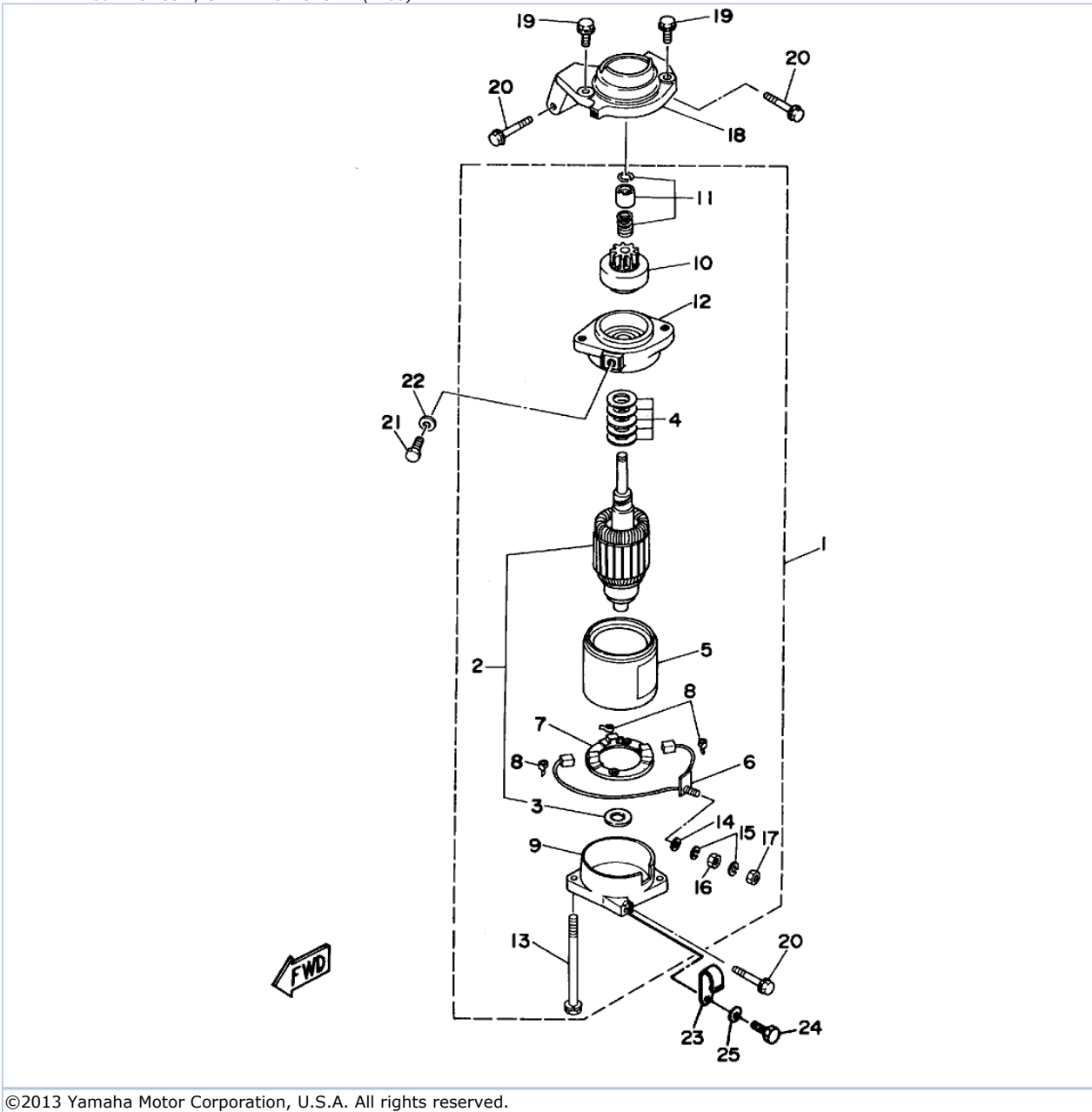

©2013 Yamaha Motor Corporation, U.S.A. All rights reserved.

Part List

P200TLRS 1994 / STARTING MOTOR 2 (P200)

REF - NO	PART NUMBER	PART NAME	QUANTITY	REMARKS
1	61H-81800-01-00	STARTING MOTOR ASSEMBLY	1	
2	61A-81850-09-00	.ARMATURE ASSEMBLY	1	
3	61A-81824-00-00	..WASHER 2	1	
4	61A-81809-00-00	.WASHER KIT	1	
5	6K7-81810-10-00	.STATOR ASSY	1	
6	6K7-81801-10-00	.BRUSH SET	1	
7	61A-81840-00-00	.BRUSH HOLDER ASSY	1	
8	6E5-81813-10-00	.SPRING, BRUSH	3	
9	61A-81820-00-00	.REAR BRACKET ASSY	1	
10	61H-81807-00-00	.GEAR ASSEMBLY, STARTING MOTOR	1	
11	61H-81857-00-00	.RETAINER	1	
12	61A-81830-00-00	.FRONT BRACKET ASSY	1	
13	6K7-81826-10-00	.BOLT	2	
14	6E5-8182E-10-00	.WASHER	1	
15	6E5-8182F-10-00	.WASHER	2	
16	6E5-8182A-10-00	.NUT	1	
17	6E5-8182K-10-00	.NUT	1	
18	6K7-81822-00-94	BRACKET, STARTING MOTOR	1	
19	90119-08M76-00	BOLT, WITH WASHER	2	
20	90119-08M77-00	BOLT, WITH WASHER	3	
21	97395-08016-00	BOLT	1	
22	92990-08600-00	.WASHER, PLATE	1	
23	90465-08028-00	CLAMP	1	
24	97095-06012-00	BOLT	1	
25	92990-06600-00	WASHER, PLATE	1	

Part Notes

P200TLRS 1994 / STARTING MOTOR 2 (P200)

PART NUMBER	NOTE TEXT
92990-06600-00 	OEM: This part number is among the Top 100 Most Popular Marine Maintenance Parts as of August 2013.

©2013 Yamaha Motor Corporation, U.S.A. All rights reserved.

P200TLRS 1994 / ELECTRICAL 1

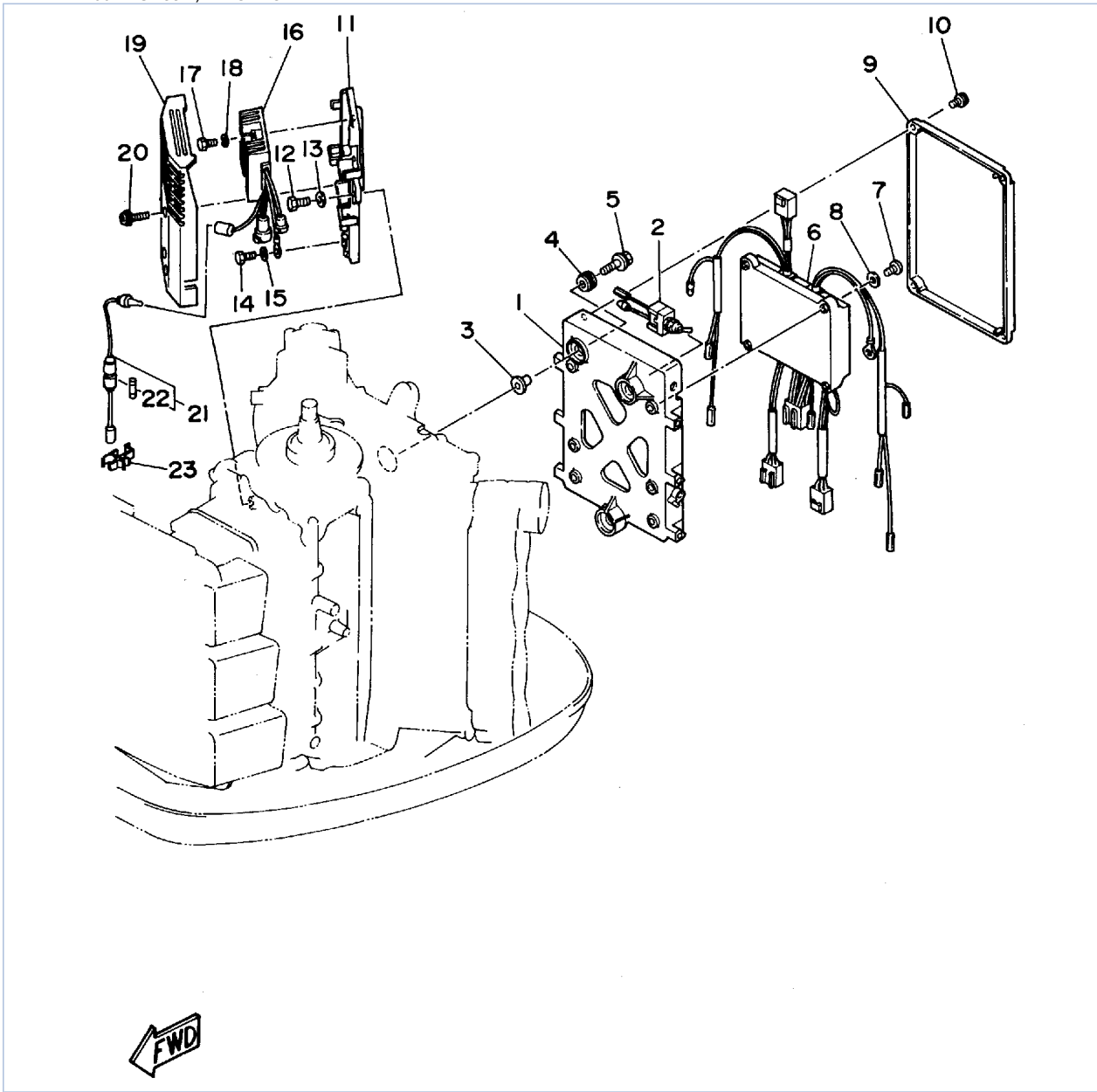

©2013 Yamaha Motor Corporation, U.S.A. All rights reserved.





Part List

P200TLRS 1994 / ELECTRICAL 1

REF - NO	PART NUMBER	PART NAME	QUANTITY	REMARKS
1	6R3-85542-01-4D	BRACKET	1	
2	6R3-8259E-00-00	SWITCH ASSY	1	
3	90387-06M03-00	COLLAR	3	
4	90480-09M12-00	GROMMET	3	
5	90119-06M60-00	BOLT, WITH WASHER	3	
6	62H-85540-00-00	C.D.I. UNIT ASSEMBLY	1	
7	98580-06020-00	SCREW, PAN HEAD	4	
8	92990-06600-00	WASHER, PLATE	4	
9	6R3-85537-00-00	COVER	1	
10	90159-06M11-00	SCREW, WITH WASHER	4	
11	6R3-81948-00-94	BRACKET	1	
12	97095-06016-00	BOLT	3	
13	92990-06600-00	WASHER, PLATE	3	
14	97013-06012-00	BOLT	1	
15	92990-06600-00	WASHER, PLATE	1	
16	6R3-81960-10-00	RECTIFIER & REGULATOR ASSY	1	
17	97095-06025-00	BOLT	2	
18	92990-06600-00	WASHER, PLATE	2	
19	6R3-81942-00-00	COVER	1	
20	90159-06M08-00	SCREW, WITH WASHER	4	
21	6R3-82150-00-00	FUSE HOLDER ASSY	1	
22	705-82151-00-00	.FUSE (30A)	1	
23	6G5-82152-00-00	HOLDER, FUSE	1	

Part Notes

P200TLRS 1994 / ELECTRICAL 1

PART NUMBER	NOTE TEXT
92990-06600-00 	OEM: This part number is among the Top 100 Most Popular Marine Maintenance Parts as of August 2013.
92990-06600-00 	OEM: This part number is among the Top 100 Most Popular Marine Maintenance Parts as of August 2013.
92990-06600-00 	OEM: This part number is among the Top 100 Most Popular Marine Maintenance Parts as of August 2013.
92990-06600-00 	OEM: This part number is among the Top 100 Most Popular Marine Maintenance Parts as of August 2013.

©2013 Yamaha Motor Corporation, U.S.A. All rights reserved.

P200TLRS 1994 / ELECTRICAL 2

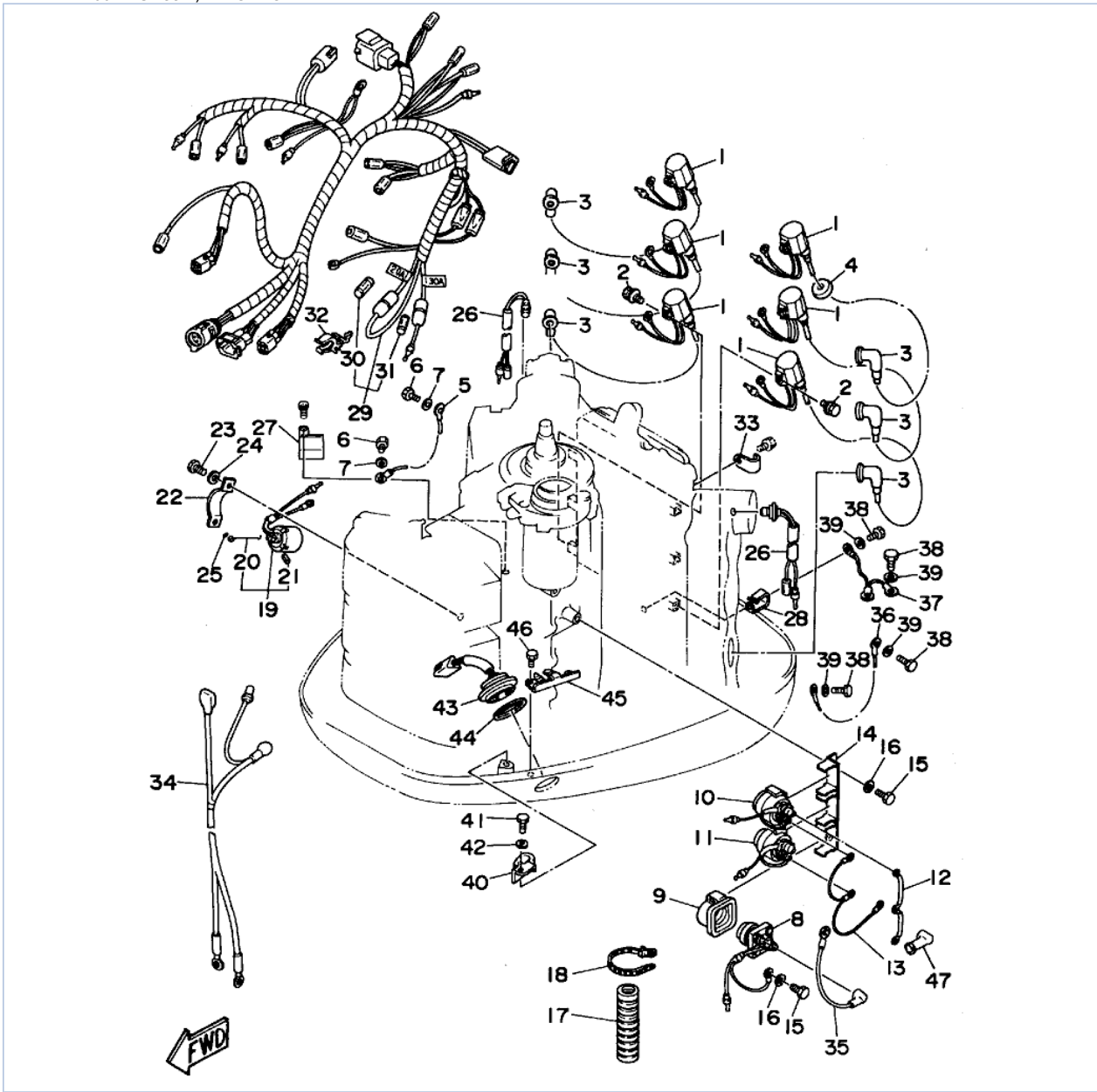

©2013 Yamaha Motor Corporation, U.S.A. All rights reserved.

Part List

P200TLRS 1994 / ELECTRICAL 2

REF - NO	PART NUMBER	PART NAME	QUANTITY	REMARKS
1	6R3-85570-01-00	IGNITION COIL ASSY	6	
2	97595-06520-00	BOLT, WITH WASHER	6	
3	663-82370-01-00	PLUG CAP ASSY	6	
4	90480-25161-00	GROMMET	1	UR
5	662-82519-00-00	WIRE, EARTH LEAD	1	
6	97095-06012-00	BOLT	2	
7	92990-06600-00	WASHER, PLATE	2	
8	61A-81941-00-00	STARTER RELAY ASSY	1	
9	689-81952-10-00	HOLDER, RELAY	1	
10	6E5-81950-00-00	RELAY ASSY	1	
11	6E5-8195A-00-00	RELAY ASSY	1	
12	6G5-87149-10-00	CONNECTOR	1	
13	6E5-82116-00-00	WIRE, MINUS LEAD	1	
14	6G5-81948-11-00	BRACKET	1	
15	97095-06016-00	BOLT	2	
16	92990-06600-00	WASHER, PLATE	2	
17	6E9-83557-70-00	TUBE	1	
18	90465-13M36-00	CLAMP	1	
19	6K7-86110-00-00	SOLENOID	1	
20	6G5-86119-00-00	.WIRE, PULL	1	
21	91690-30010-00	.PIN, SPRING	1	
22	6K7-86115-00-00	HOLDER, SOLENOID	1	
23	97095-06016-00	BOLT	2	
24	92990-06600-00	WASHER, PLATE	2	
25	93210-03261-00	O-RING	1	
26	688-82560-10-00	THERMO SWITCH ASSY	2	
27	90465-08M33-00	CLAMP	1	
28	90465-10M14-00	CLAMP	1	
29	6R3-82590-13-00	WIRE HARNESS ASSEMBLY	1	
30	682-82151-00-00	.FUSE (12V-20A)	1	
31	705-82151-00-00	.FUSE (30A)	1	
32	6G5-82152-00-00	HOLDER, FUSE	2	
33	90465-08028-00	CLAMP	2	
34	6R3-82105-00-00	WIRE HARNESS	1	
35	6E5-82117-00-00	WIRE, LEAD	1	UR P150/175
35	6K7-82117-00-00	WIRE, LEAD	1	UR P200
36	6R3-82519-00-00	WIRE, EARTH LEAD	1	
37	6E5-82531-00-00	WIRE, LEAD	1	
38	97095-06012-00	BOLT	4	
39	92990-06600-00	WASHER, PLATE	4	
40	90465-12M25-00	CLAMP	1	
41	97095-06012-00	BOLT	1	
42	92990-06600-00	WASHER, PLATE	1	
43	6R3-82563-00-00	TRIM & TILT SWITCH ASSY	1	
44	6E5-82587-00-00	GASKET	1	
45	6R3-83614-00-00	BRACKET	1	
46	97095-06016-00	BOLT	2	
47	6G5-82119-00-00	COVER, LEAD WIRE	2	

Part Notes

P200TLRS 1994 / ELECTRICAL 2

PART NUMBER	NOTE TEXT
92990-06600-00	OEM: This part number is among the Top 100 Most Popular Marine Maintenance Parts as of August 2013.

		
92990-06600-00		OEM: This part number is among the Top 100 Most Popular Marine Maintenance Parts as of August 2013.
92990-06600-00		OEM: This part number is among the Top 100 Most Popular Marine Maintenance Parts as of August 2013.
92990-06600-00		OEM: This part number is among the Top 100 Most Popular Marine Maintenance Parts as of August 2013.
92990-06600-00		OEM: This part number is among the Top 100 Most Popular Marine Maintenance Parts as of August 2013.

©2013 Yamaha Motor Corporation, U.S.A. All rights reserved.

P200TLRS 1994 / REPAIR KIT 1

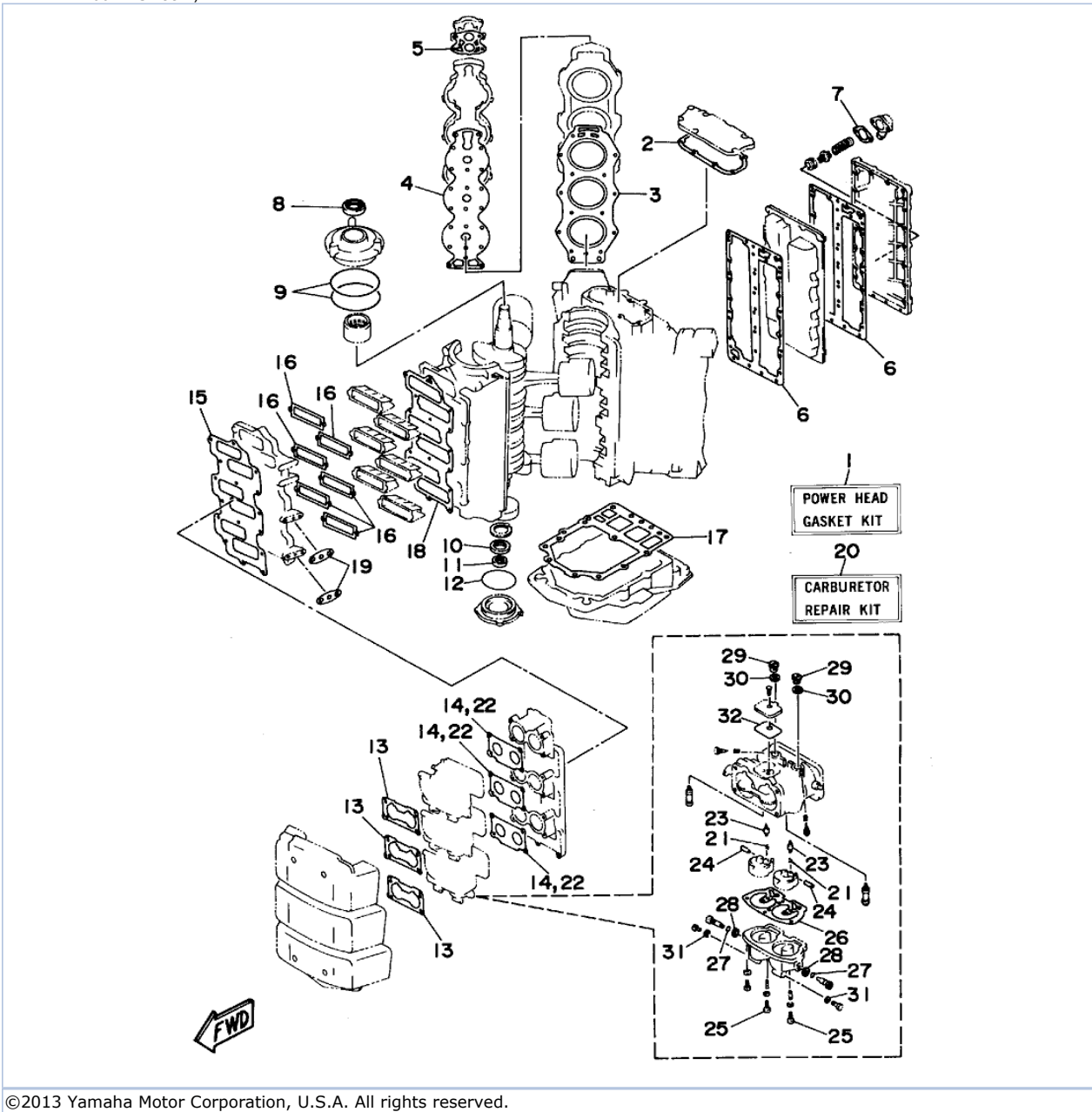

©2013 Yamaha Motor Corporation, U.S.A. All rights reserved.



Part List

P200TLRS 1994 / REPAIR KIT 1

REF - NO	PART NUMBER	PART NAME	QUANTITY	REMARKS
1	6K7-W0001-04-00	POWER HEAD GASKET KIT	1	
2	6E5-11381-A1-00	.GASKET 1	1	
3	6G5-11181-A0-00	.GASKET, CYLINDER HEAD 1	2	
4	6G5-11193-A0-00	.GASKET, HEAD COVER 1	2	
5	688-12414-A1-00	.GASKET, COVER	2	
6	6G5-41112-A1-00	.GASKET, EXHAUST INNER COVER	2	
7	6G5-11382-A1-00	.GASKET 2	1	
8	93102-40M38-00	.OIL SEAL	1	
9	93211-04384-00	.O-RING	2	
10	93102-35M13-00	.OIL SEAL	1	
11	93101-22M15-00	.OIL SEAL	1	
12	93210-74M35-00	.O-RING	1	
13	6K7-14483-00-00	.GASKET	3	
14	6E5-14198-A1-00	.GASKET	3	
15	6K7-13645-A1-00	.GASKET, MANIFOLD 1	1	
16	6K7-13621-A1-00	.GASKET, VALVE SEAT	6	
17	6G5-45113-A0-00	.GASKET, UPPER CASING	1	
18	6K7-13646-A1-00	.GASKET, MANIFOLD 2	1	
19	650-24431-A0-00	.GASKET, FUEL PUMP 1	2	
20	6E5-W0093-06-00	CARBURETOR REPAIR KIT	1	
21	6E5-14159-00-00	.CLIP	2	
22	6E5-14198-A1-00	.GASKET	1	
23	6E5-14546-00-00	.VALVE, NEEDLE	2	
24	6E5-14386-02-00	.PIN, FLOAT	2	
25	6E5-14394-00-00	.PLUG, SLOW JET	2	
26	6E5-14384-03-00	.GASKET, FLOAT CHAMBER	1	
27	6E5-14997-00-00	.O-RING	2	
28	6E5-14398-01-00	.GASKET	2	
29	6E5-14328-01-00	.PLUG	2	
30	6E5-14979-00-00	.GASKET	2	
31	6J8-14995-00-00	.GASKET	2	
32	6E5-14959-01-00	.GASKET	1	

Part Notes

P200TLRS 1994 / REPAIR KIT 1

PART NUMBER		NOTE TEXT
688-12414-A1-00		OEM: This part number is among the Top 100 Most Popular Marine Maintenance Parts as of August 2013.
650-24431-A0-00		OEM: This part number is among the Top 100 Most Popular Marine Maintenance Parts as of August 2013.

©2013 Yamaha Motor Corporation, U.S.A. All rights reserved.

P200TLRS 1994 / REPAIR KIT 2

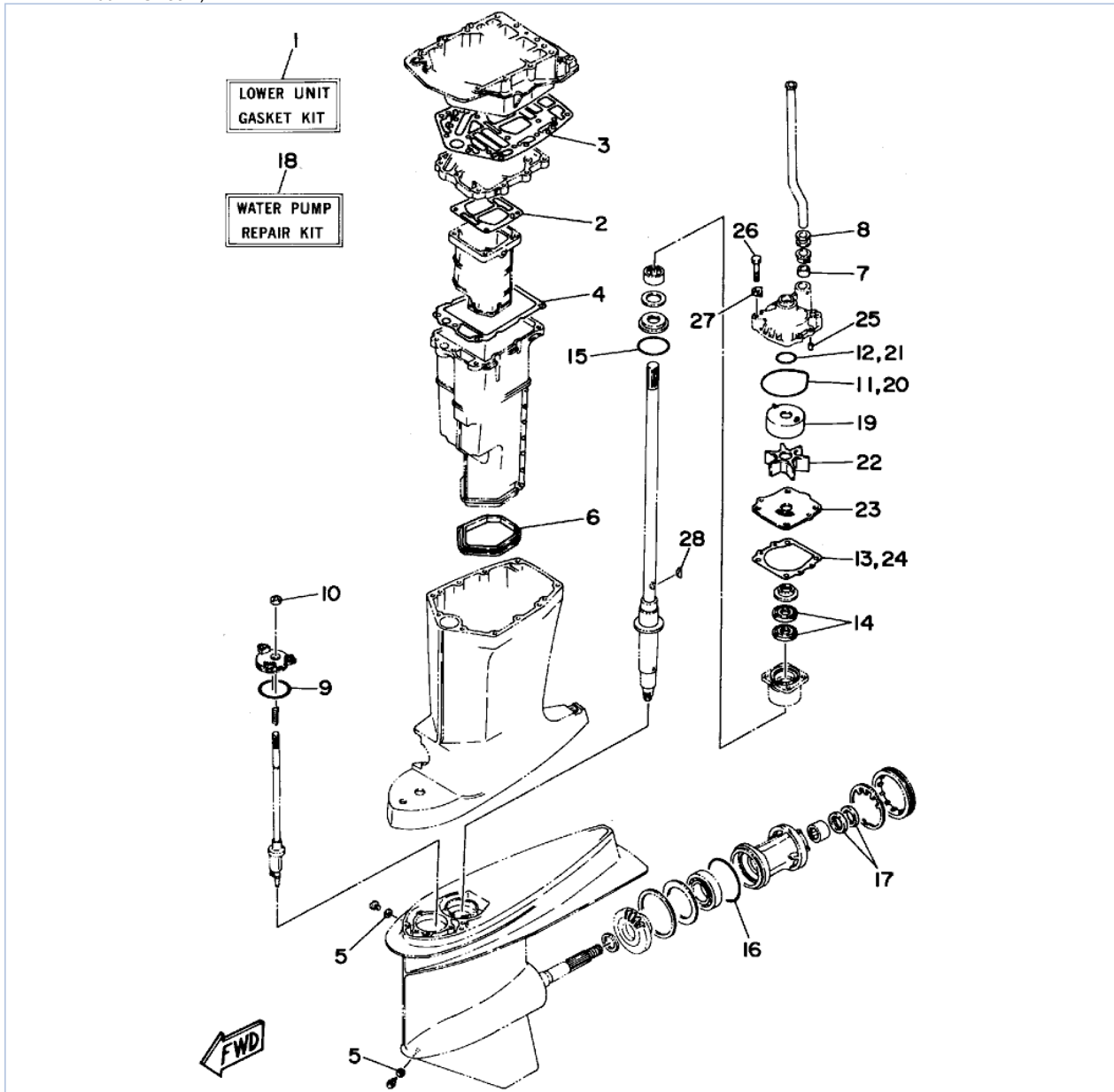

©2013 Yamaha Motor Corporation, U.S.A. All rights reserved.







Part List

P200TLRS 1994 / REPAIR KIT 2

REF - NO	PART NUMBER	PART NAME	QUANTITY	REMARKS
1	6G5-W0001-21-00	LOWER UNIT GASKET KIT	1	
2	6G5-41134-A0-00	.GASKET, EXHAUST MANIFOLD	1	
3	6G5-45114-A0-00	.GASKET, UPPER CASING	1	
4	6E5-41135-A0-00	.GASKET, EXHAUST MANIFOLD	1	
5	90430-08020-00	.GASKET	2	
6	6E5-45123-00-00	.GASKET, MUFFLER	1	
7	6E5-44365-00-00	.DAMPER, WATER SEAL 1	1	
8	6E5-44366-00-00	.DAMPER, WATER SEAL 2	1	
9	93210-58677-00	.O-RING	1	
10	93106-09014-00	.OIL SEAL	1	
11	93210-86M38-00	.O-RING	1	
12	93210-37M67-00	.O-RING	1	
13	6E5-44315-A0-00	.GASKET, WATER PUMP	1	
14	93101-28M16-00	.OIL SEAL	2	
15	93210-54534-00	.O-RING	1	
16	93210-97M55-00	.O-RING	1	
17	93101-30M17-00	.OIL SEAL	2	
18	61A-W0078-01-00	WATER PUMP REPAIR KIT	1	
19	61A-44322-00-00	.INSERT, CARTRIDGE	1	
20	93210-86M38-00	.O-RING	1	
21	93210-37M67-00	.O-RING	1	
22	6E5-44352-00-00	.IMPELLER	1	
23	6G5-44323-00-00	.OUTER PLATE, CARTRIDGE	1	
24	6E5-44315-A0-00	.GASKET, WATER PUMP	1	
25	93606-12019-00	.PIN, DOWEL	1	
26	97395-08045-00	.BOLT	4	
27	90209-08M02-00	.WASHER	4	
28	90280-04M05-00	.KEY, WOODRUFF	1	

Part Notes

P200TLRS 1994 / REPAIR KIT 2

PART NUMBER		NOTE TEXT
90430-08020-00		OEM: This part number is among the Top 100 Most Popular Marine Maintenance Parts as of August 2013.
93106-09014-00		OEM: This part number is among the Top 100 Most Popular Marine Maintenance Parts as of August 2013.
93210-86M38-00		OEM: This part number is among the Top 100 Most Popular Marine Maintenance Parts as of August 2013.
93101-28M16-00		OEM: This part number is among the Top 100 Most Popular Marine Maintenance Parts as of August 2013.
93210-54534-00		OEM: This part number is among the Top 100 Most Popular Marine Maintenance Parts as of August 2013.
93101-30M17-00		OEM: This part number is among the Top 100 Most Popular Marine Maintenance Parts as of August 2013.
93210-86M38-00		OEM: This part number is among the Top 100 Most Popular Marine Maintenance Parts as of August 2013.

©2013 Yamaha Motor Corporation, U.S.A. All rights reserved.

©2013 Yamaha Motor Corporation, U.S.A. All rights reserved.