

PROV150LH 1987 / CRANKCASE CYLINDER

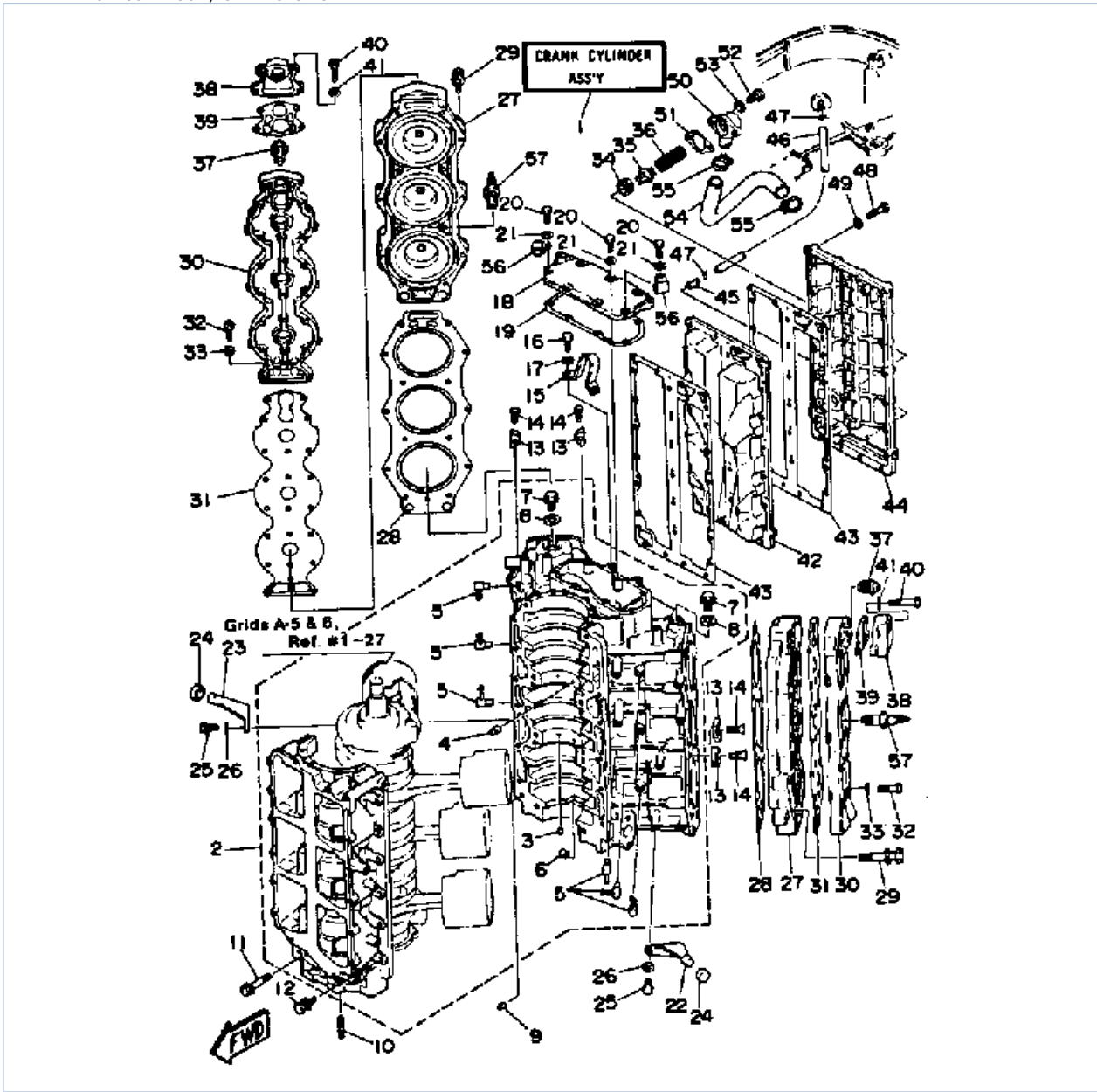

©2013 Yamaha Motor Corporation, U.S.A. All rights reserved.

Part List

PROV150LH 1987 / CRANKCASE CYLINDER

REF - NO	PART NUMBER	PART NAME	QUANTITY	REMARKS
1	6J9-W0090-04-EK	CRANK- CYLINDER.ASSEMBLY.	1	
2	6J9-15100-02-94	CRANKCASE ASSEMBLY	1	
3	624-11379-00-00	.VALVE, CHECK	2	
4	663-11518-01-00	.LOCK, BEARING	2	
5	646-11370-00-00	.CHECK VALVE ASSY	6	
6	90380-06M24-00	.BUSH, SOLID (90380- 06M18-00)	1	
7	90340-14M00-00	.PLUG, STRAIGHT SCREW	2	
8	90430-14115-00	.GASKET	2	
9	93608-12063-00	PIN, DOWEL	2	
10	90116-08M14-00	BOLT, STUD	2	
11	90105-10M20-00	BOLT, FLANGE	8	
12	90119-08M23-00	BOLT, W/WASHER	12	
13	6E5-11325-00-00	ANODE	8	
14	98680-04016-00	SCREW OVAL HEAD	8	
15	6E5-11119-00-00	HANGER, ENGINE	1	
16	97313-08020-00	BOLT, HEXAGON	2	
17	92990-08100-00	WASHER, SPRING	2	
18	6E5-11371-00-9M	COVER	1	
19	6E5-11381-00-00	GASKET 1	1	
20	97313-06020-00	BOLT, HEXAGON	7	
21	92990-06600-00	WASHER, PLATE	7	
22	6E5-42761-00-94	STOPPER	1	
23	6E5-42762-00-94	STOPPER	1	
24	663-44533-00-00	DAMPER, UPPER MOUNT RUBBER	2	
25	97313-06020-00	BOLT, HEXAGON	4	
26	92990-06600-00	WASHER, PLATE	4	
27	6J9-11111-00-94	HEAD, CYLINDER 1	2	
28	6G5-11181-A0-00	GASKET, CYLINDER HEAD 1	2	
29	90119-08M21-00	BOLT, WITH WASHER	28	
30	6G5-11191-00-9M	COVER, CYLINDER HEAD 1	2	
31	6G5-11193-01-00	GASKET, HEAD COVER 1	2	
32	97313-06030-00	BOLT	36	
33	92990-06600-00	WASHER, PLATE	36	
34	90480-20M05-00	GROMMET	1	
35	6G5-12416-00-00	VALVE, PRESSURE CONTROL	1	
36	90501-16M11-00	SPRING, COMPRESSION	1	
37	6E5-12411-20-00	THERMOSTAT	2	
38	6G5-12413-00-9M	COVER, THERMOSTAT	2	
39	688-12414-A1-00	.GASKET, COVER	2	
40	97313-06045-00	BOLT, HEXAGON	8	
41	92990-06600-00	WASHER, PLATE	8	
42	6G5-41111-00-9M	INNER COVER, EXHAUST	1	
43	6G5-41112-A1-00	GASKET, EXHAUST INNER COVER	2	
44	6G5-41113-00-9M	OUTER COVER, EXHAUST	1	
45	652-24461-00-00	PIPE, JOINT 4	1	
46	6E5-24312-00-00	PIPE 2	1	
47	90467-08004-00	CLIP	2	
48	97013-06035-00	BOLT	29	
49	92990-06600-00	WASHER, PLATE	29	
50	6G5-11372-00-5B	NIPPLE, HOSE (6G5-11372- 00-9M)	1	

51	6G5-11382-A1-00	.GASKET 2	1	
52	97313-06020-00	BOLT, HEXAGON	2	
53	92990-06600-00	WASHER, PLATE	2	
54	6G5-12576-00-00	HOSE 1	1	
55	90465-13M36-00	CLAMP	2	
56	90465-08028-00	CLAMP	2	
57	NGK-B8HS1-00-00	PLUG, SPARK (NGK B8HS-10)	6	

Part Notes

PROV150LH 1987 / CRANKCASE CYLINDER

PART NUMBER		NOTE TEXT
92990-06600-00		OEM: This part number is among the Top 100 Most Popular Marine Maintenance Parts as of August 2013.
92990-06600-00		OEM: This part number is among the Top 100 Most Popular Marine Maintenance Parts as of August 2013.
92990-06600-00		OEM: This part number is among the Top 100 Most Popular Marine Maintenance Parts as of August 2013.
90480-20M05-00		OEM: This part number is among the Top 100 Most Popular Marine Maintenance Parts as of August 2013.
688-12414-A1-00		OEM: This part number is among the Top 100 Most Popular Marine Maintenance Parts as of August 2013.
92990-06600-00		OEM: This part number is among the Top 100 Most Popular Marine Maintenance Parts as of August 2013.
92990-06600-00		OEM: This part number is among the Top 100 Most Popular Marine Maintenance Parts as of August 2013.
92990-06600-00		OEM: This part number is among the Top 100 Most Popular Marine Maintenance Parts as of August 2013.

©2013 Yamaha Motor Corporation, U.S.A. All rights reserved.

PROV150LH 1987 / CRANK PISTON

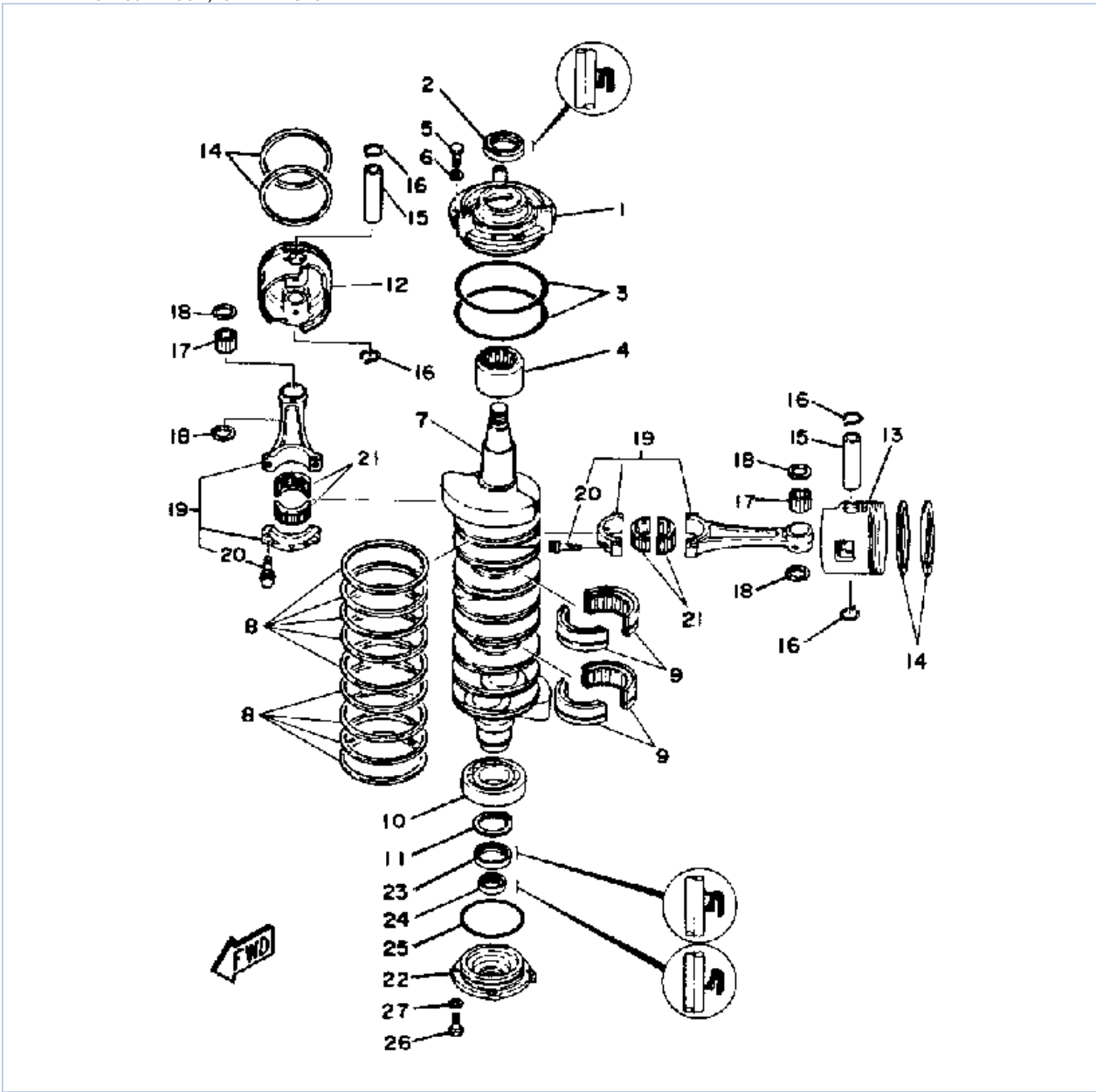

©2013 Yamaha Motor Corporation, U.S.A. All rights reserved.



Part List

PROV150LH 1987 / CRANK PISTON

REF - NO	PART NUMBER	PART NAME	QUANTITY	REMARKS
1	6E5-15163-00-94	HOUSING, BEARING 1	1	
2	93102-40M38-00	OIL SEAL	1	
3	93211-04384-00	.O-RING	2	
4	93311-940U3-00	BEARING	1	
5	97313-06020-00	BOLT, HEXAGON	4	
6	92990-06600-00	WASHER, PLATE	4	
7	6G5-11411-00-00	CRANKSHAFT	1	
8	6E5-11447-00-00	SEAL, CRANK	9	
9	93310-954V3-00	BEARING, CYLINDRICAL	2	
10	93306-208U0-00	BEARING	1	
11	93410-40M03-00	CIRCLIP	1	
12	6G5-11631-00-93	PISTON STD (STD)	3	
12	6G5-11636-00-00	PISTON 2 O/S 0.50 (2ND O.S.)	3	AP
13	6G5-11642-00-93	PISTON STD (STD)	3	
13	6G5-11646-00-00	PISTON 2ND (2ND O.S.)	3	AP
14	6J9-11610-20-00	PISTON RINGSET 2ND (2ND O.S.)	6	AP
14	6E5-11610-03-00	PISTON RING SET	6	
15	6E5-11633-01-00	PIN, PISTON	6	
16	6E5-11634-00-00	CLIP, PISTON PIN	12	
17	93603-21111-00	PIN, DOWEL	180	
18	90201-21M75-00	WASHER, PLATE	12	
19	6E5-11650-01-00	CONNECTING ROD ASSY	6	
20	90109-08M61-00	.BOLT	2	
21	93310-836V2-00	BEARING	6	
22	6G5-15359-00-94	HOUSING, OIL SEAL	1	
23	93102-35M13-00	OIL SEAL	1	
24	93101-22M15-00	.OIL SEAL	1	
25	93210-74M35-00	.O-RING	1	
26	97395-06020-00	BOLT, HEXAGON	4	
27	92990-06600-00	WASHER, PLATE	4	

Part Notes

PROV150LH 1987 / CRANK PISTON

PART NUMBER		NOTE TEXT
92990-06600-00		OEM: This part number is among the Top 100 Most Popular Marine Maintenance Parts as of August 2013.
93603-21111-00		OEM: This part number is among the Top 100 Most Popular Marine Maintenance Parts as of August 2013.
92990-06600-00		OEM: This part number is among the Top 100 Most Popular Marine Maintenance Parts as of August 2013.

©2013 Yamaha Motor Corporation, U.S.A. All rights reserved.

PROV150LH 1987 / INTAKE

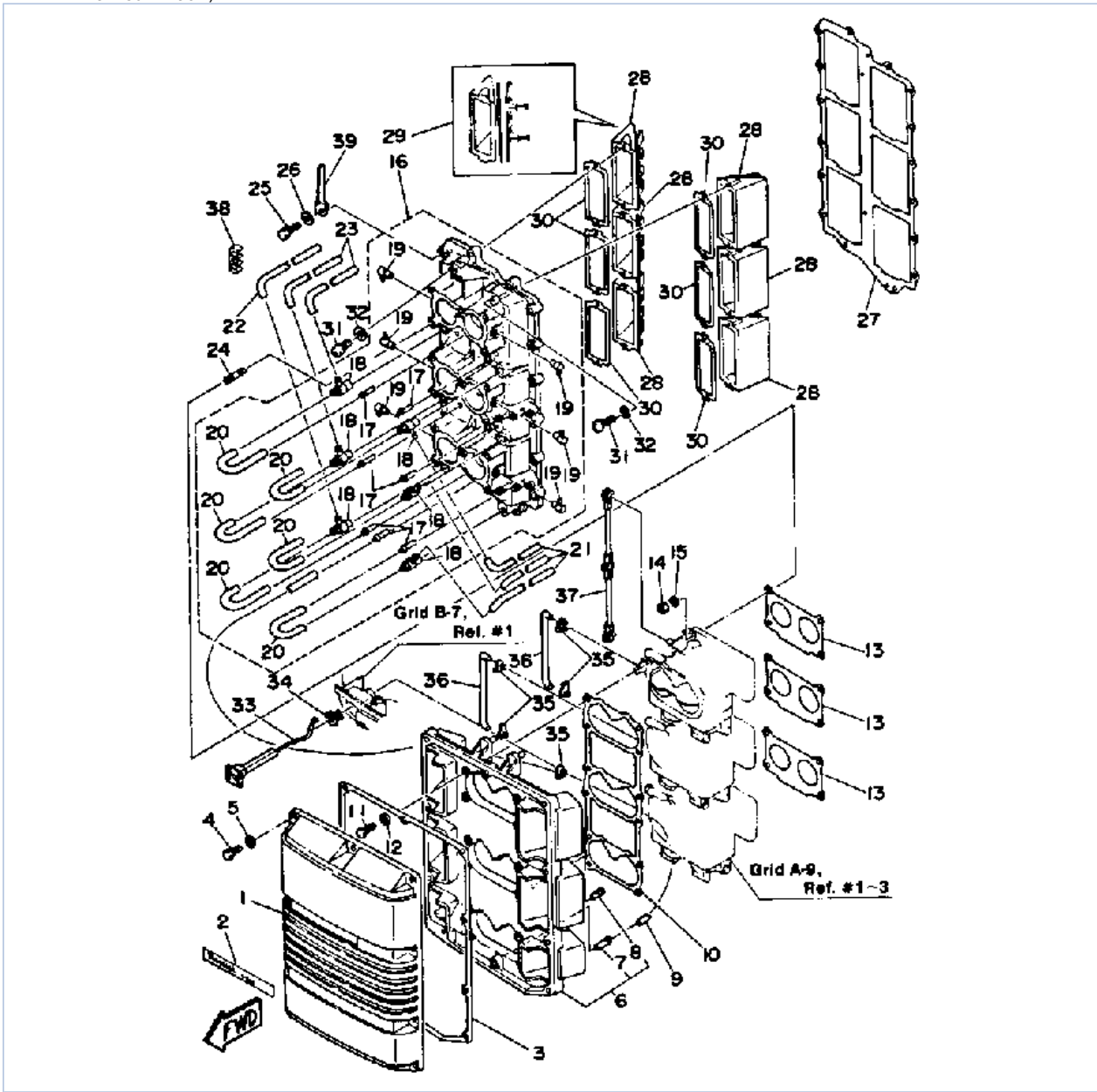

©2013 Yamaha Motor Corporation, U.S.A. All rights reserved.





Part List

PROV150LH 1987 / INTAKE

REF - NO	PART NUMBER	PART NAME	QUANTITY	REMARKS
1	6G5-14418-00-00	COVER 2	1	
2	6G5-1441K-00-00	EMBLEM	1	
3	6G5-14416-00-00	GASKET, AIR CLEANER	1	
4	97313-06020-00	BOLT, HEXAGON	10	
5	92990-06600-00	WASHER, PLATE	10	
6	6G5-14417-10-94	COVER 1	1	
7	624-14485-00-00	.PIPE, JOINT	1	
8	6E5-14485-00-00	.PIPE, JOINT	1	
9	90445-07M23-00	HOSE (L408)	1	
10	6G5-14483-01-00	GASKET	1	
11	97313-06020-00	BOLT, HEXAGON	12	
12	92990-06600-00	WASHER, PLATE	12	
13	6E5-14198-A1-00	GASKET	3	
14	95380-06600-00	NUT, HEXAGON	12	
15	92995-06100-00	WASHER, SPRING	12	
16	6G5-13641-10-94	MANIFOLD 1	1	
17	624-14485-00-00	.PIPE, JOINT	7	
18	6E5-11370-00-00	.CHECK VALVE ASSY	6	
19	6E5-13552-00-00	.NOZZLE	6	
20	90445-07M28-00	.HOSE (L70)	6	
21	90445-07M45-00	HOSE (L340)	3	
22	90445-07M59-00	HOSE (L410)	1	
23	90445-07M46-00	HOSE (L360)	2	
24	90116-06M30-00	BOLT, STUD	12	
25	97313-06025-00	BOLT	16	
26	92990-06600-00	WASHER, PLATE	16	
27	6G5-13645-A1-00	GASKET, MANIFOLD 1	1	
28	6G5-13610-00-00	REED VALVE ASSY	6	
29	6E5-W0004-00-00	.REED SET	1	
30	6E5-13621-00-00	GASKET, VALVE SEAT	6	
31	98580-05016-00	SCREW, PAN HEAD	12	
32	92990-05600-00	WASHER, PLATE	12	
33	6E5-41271-02-00	KNOB, CHOKE	1	
34	689-41273-00-00	GROMMET	1	
35	661-41262-02-00	JOINT, CHOKE LEVER	5	
36	6E5-41256-01-00	ROD, CHOKE 1	2	
37	6G5-41217-01-00	ROD, ACCEL. LEVER	1	
38	90464-07M05-00	CLAMP	2	
39	90465-07M20-00	CLAMP	4	

Part Notes

PROV150LH 1987 / INTAKE

PART NUMBER	NOTE TEXT
92990-06600-00 	OEM: This part number is among the Top 100 Most Popular Marine Maintenance Parts as of August 2013.
92990-06600-00 	OEM: This part number is among the Top 100 Most Popular Marine Maintenance Parts as of August 2013.
92995-06100-00 	OEM: This part number is among the Top 100 Most Popular Marine Maintenance Parts as of August 2013.
92990-06600-00 	OEM: This part number is among the Top 100 Most Popular Marine Maintenance Parts as of August 2013.

©2013 Yamaha Motor Corporation, U.S.A. All rights reserved.

PROV150LH 1987 / CARBURETOR

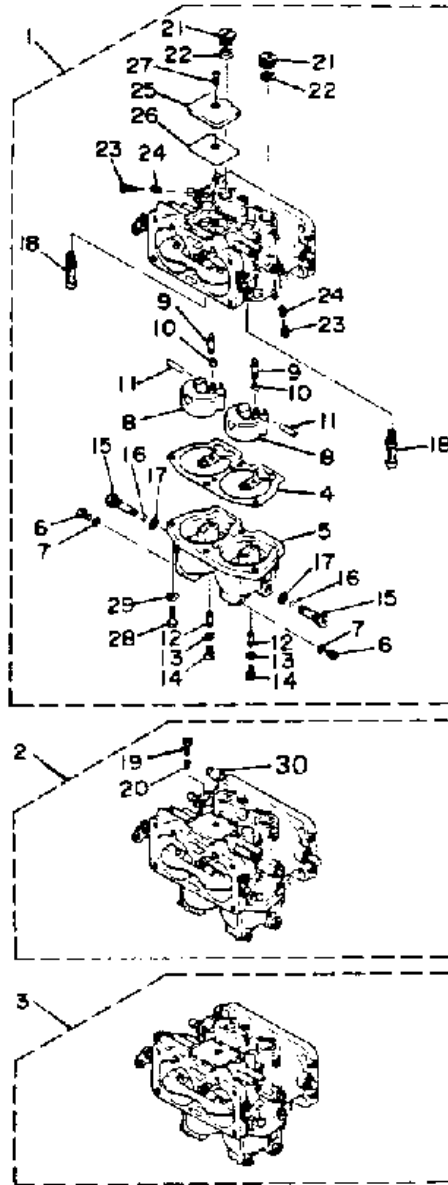

©2013 Yamaha Motor Corporation, U.S.A. All rights reserved.

Part List

PROV150LH 1987 / CARBURETOR

REF - NO	PART NUMBER	PART NAME	QUANTITY	REMARKS
1	6J9-14301-03-00	CARBURETOR (UPPER)	1	
2	6J9-14302-02-00	CARBURETOR (CENTER)	1	
3	6J9-14303-03-00	CARBURETOR (LOWER)	1	
4	6E5-14384-03-00	.GASKET, FLOAT CHAMBER	3	
5	6E5-14381-03-00	.BODY, FLOAT CHAMBER	3	
6	6E5-14383-01-00	.SCREW, DRAIN	6	
7	6J8-14995-00-00	.GASKET	6	
8	6E5-14385-02-00	.FLOAT	6	
9	6E5-14546-00-00	.VALVE, NEEDLE	6	
10	6E5-14159-00-00	.CLIP	6	
11	6E5-14386-02-00	.PIN, FLOAT	6	
12	6E5-1492F-40-00	.JET, AIR SLOW (#80)	6	
13	6E5-14397-00-00	.O-RING	6	
14	6E5-14394-00-00	.PLUG, SLOW JET	6	
15	6E5-1492E-62-00	.JET, MAIN (#124)	6	
16	6E5-14997-00-00	.O-RING	6	
17	6E5-14398-01-00	.GASKET	6	
18	6J9-1492A-00-00	.NOZZLE, MAIN	6	
19	6E5-14321-00-00	.SCREW, THROTTLE	1	
20	6J8-14334-00-00	.SPRING, THROTTLE	1	
21	6E5-14328-01-00	.PLUG	6	
22	6E5-14979-00-00	.GASKET	6	
23	6E5-14323-03-00	.SCREW, AIR ADJUSTING	6	
24	6E5-14223-00-00	.SPRING, AIR ADJUSTING	6	
25	6E5-14527-00-00	.PLATE	3	
26	6E5-14959-01-00	.GASKET	3	
27	98701-05008-00	.SCREW, FLAT HEAD	3	
28	98580-05016-00	.SCREW, PAN HEAD	12	
29	92990-05100-00	.WASHER, SPRING	12	
30	682-41291-00-00	.BUSHING	1	

PROV150LH 1987 / FUEL SYSTEM 1

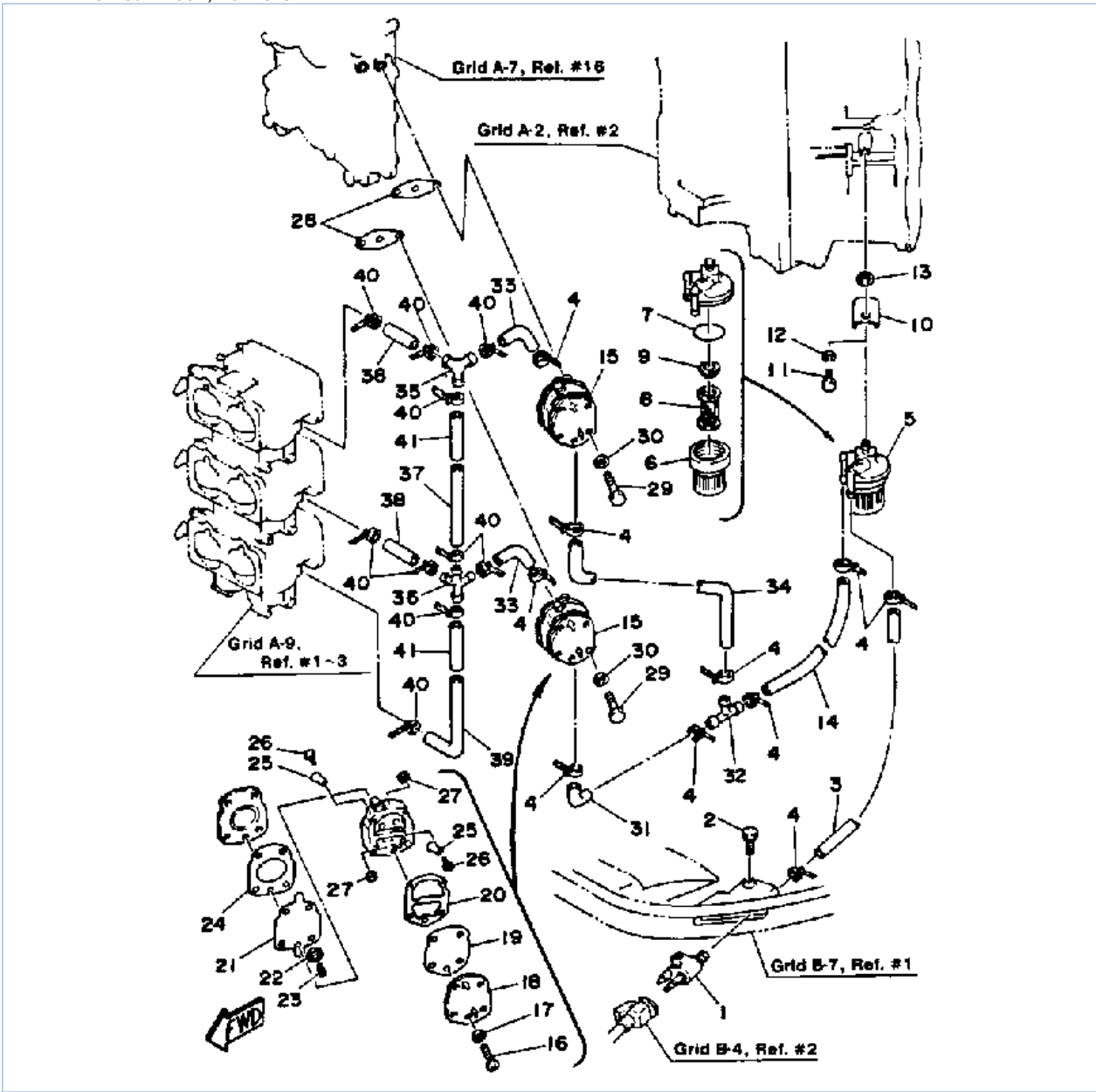

©2013 Yamaha Motor Corporation, U.S.A. All rights reserved.





Part List

PROV150LH 1987 / FUEL SYSTEM 1

REF - NO	PART NUMBER	PART NAME	QUANTITY	REMARKS
1	6E5-24304-10-00	FUEL PIPE JOINT COMP. 1	1	
2	97313-06020-00	BOLT, HEXAGON	1	
3	6G5-24313-00-00	PIPE 3	1	
4	90465-11M10-00	CLAMP	10	
5	6E5-24560-00-00	FILTER ASSY	1	
6	655-24521-01-00	.CUP, FILTER	1	
7	93210-37M25-00	.O-RING	1	
8	6F5-24563-00-00	.ELEMENT, FILTER	1	
9	655-24564-00-00	.GASKET	1	
10	648-24566-01-00	BRACKET, FILTER	1	
11	97313-06014-00	BOLT, HEXAGON	1	
12	92995-06100-00	WASHER, SPRING	1	
13	95333-08600-00	NUT	1	
14	6G5-24314-00-00	PIPE 4	1	
15	6E5-24410-03-00	FUEL PUMP ASSY	2	
16	98580-05035-00	.SCREW, PAN HEAD	3	
17	92990-05600-00	.WASHER, PLATE	3	
18	6E5-24413-00-00	.BODY 2	1	
19	6E5-24471-00-00	.DIAPHRAGM	1	
20	6E5-24435-00-00	.GASKET, BODY 2	1	
21	6E5-24411-00-00	.DIAPHRAGM	1	
22	648-24424-00-00	.SEAT, SPRING	1	
23	6E5-24423-00-00	.SPRING, DIAPHRAGM	1	
24	6E5-24434-02-00	.GASKET, BODY	1	
25	6A0-24421-01-00	.VALVE, CHECK	4	
26	90147-03M00-00	.SCREW, PAN HEAD	4	
27	98813-03100-00	.NUT	4	
28	650-24431-A0-00	GASKET, FUEL PUMP 1	2	
29	97313-06050-00	BOLT	4	
30	92990-06600-00	WASHER, PLATE	4	
31	6E5-24315-00-00	PIPE 5	1	
32	6E5-24378-00-00	PIPE, JOINT 3	1	
33	6G5-24316-10-00	PIPE 6	2	
34	6G5-24315-00-00	PIPE 5	1	
35	6G5-24376-00-00	PIPE, JOINT 1	1	
36	6G5-24377-00-00	PIPE, JOINT 2	1	
37	6G5-24317-01-00	PIPE 7	1	
38	6G5-24318-10-00	PIPE, OVERFLOW	2	
39	6G5-24319-10-00	PIPE, OIL	1	
40	90465-11M10-00	CLAMP	10	
41	90446-15M07-00	HOSE (L60)	2	

Part Notes

PROV150LH 1987 / FUEL SYSTEM 1

PART NUMBER		NOTE TEXT
92995-06100-00		OEM: This part number is among the Top 100 Most Popular Marine Maintenance Parts as of August 2013.
6E5-24410-03-00		OEM: This part number is among the Top 100 Most Popular Marine Maintenance Parts as of August 2013.
650-24431-A0-00		OEM: This part number is among the Top 100 Most Popular Marine Maintenance Parts as of August 2013.
92990-06600-00		OEM: This part number is among the Top 100 Most Popular Marine Maintenance Parts as of August 2013.

©2013 Yamaha Motor Corporation, U.S.A. All rights reserved.

PROV150LH 1987 / FUEL SYSTEM 2

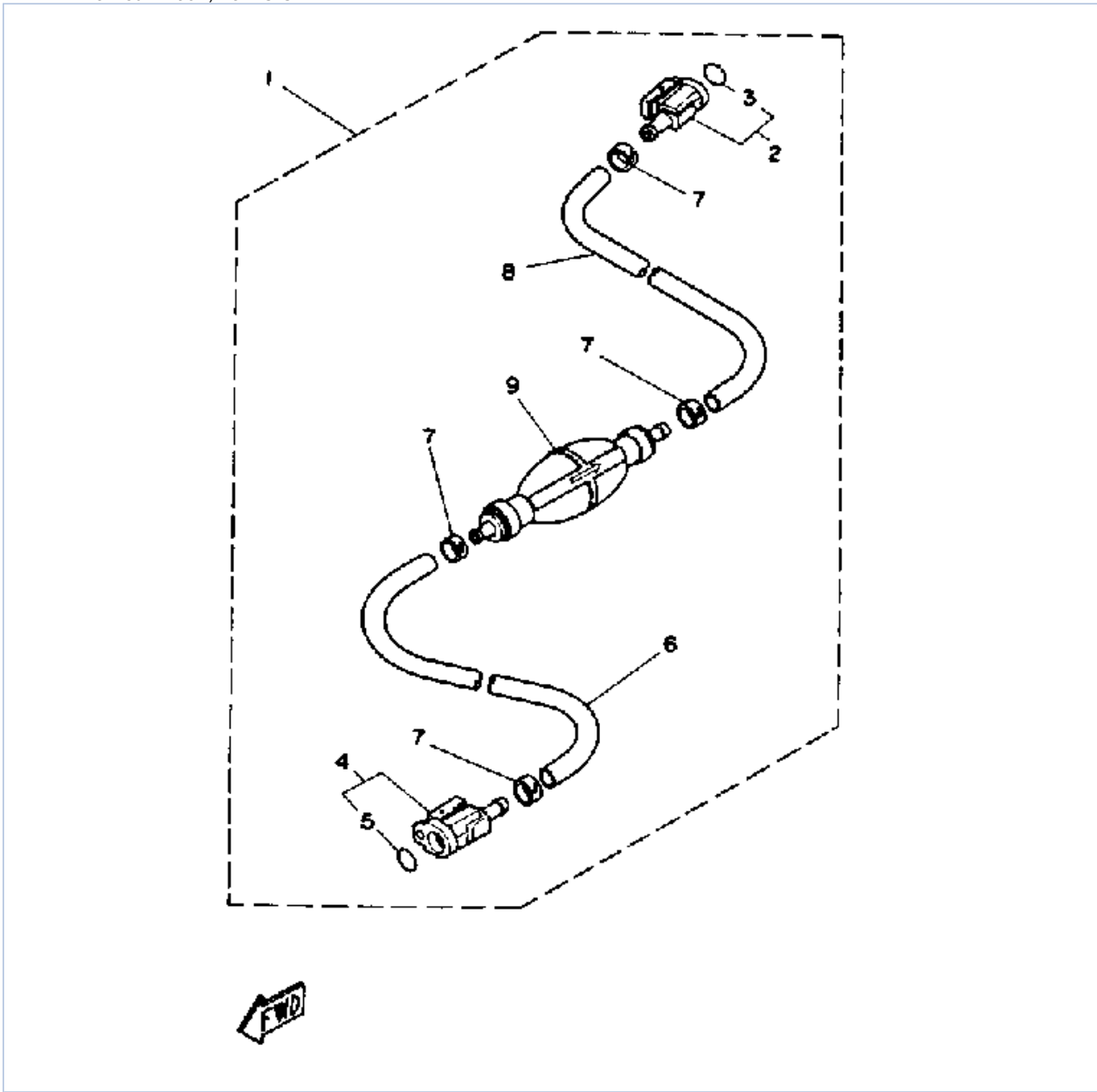

©2013 Yamaha Motor Corporation, U.S.A. All rights reserved.

Part List

PROV150LH 1987 / FUEL SYSTEM 2

REF - NO	PART NUMBER	PART NAME	QUANTITY	REMARKS
1	6Y2-24306-51-00	FUEL PIPE COMP 1	1	
2	6E5-24305-02-00	.FUEL PIPE JOINT COMP 2	1	
3	93210-08287-00	..O-RING	1	
4	6Y2-24305-02-00	.FUEL PIPE JOINT COMP 2	1	
5	93210-08287-00	..O-RING	1	
6	90445-13M01-00	.HOSE (L2050)	1	
7	6E5-24351-51-00	.BAND 1	4	
8	90445-13M00-00	.HOSE (L850)	1	
9	6Y2-24360-51-00	.PRIMER PUMP ASSY	1	

PROV150LH 1987 / TOP COWLING

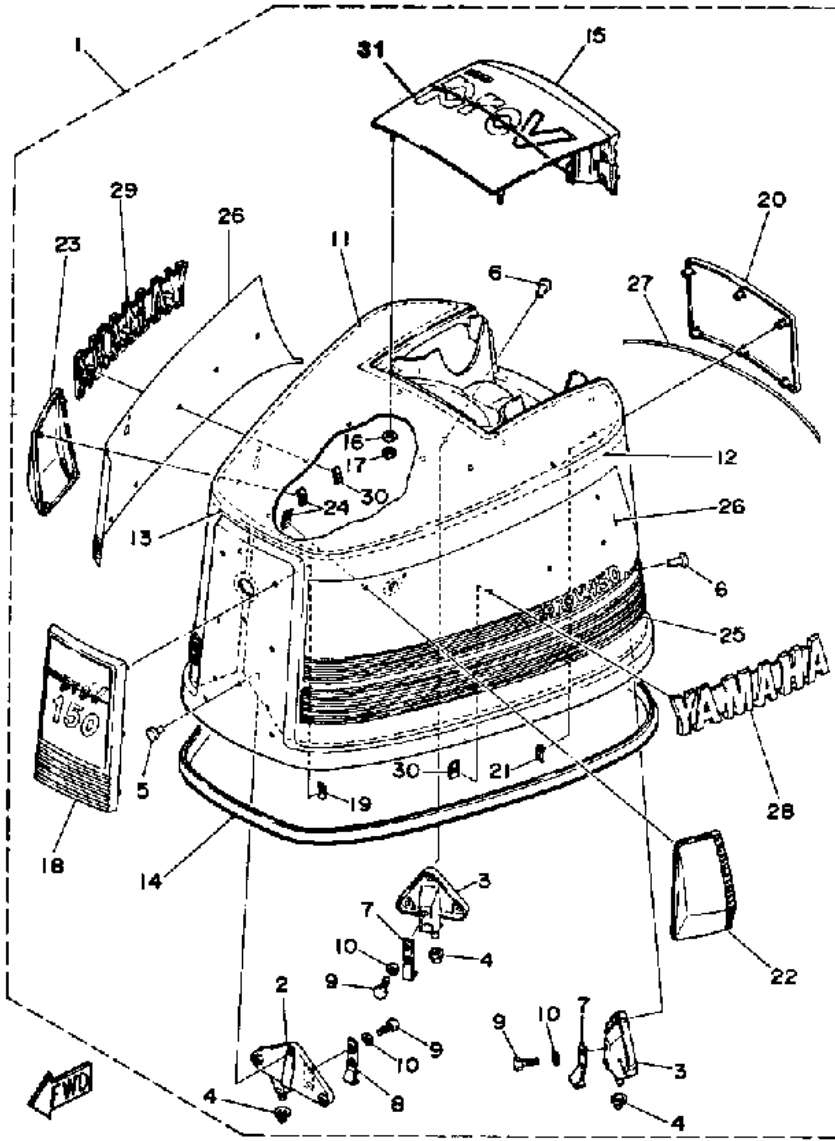

©2013 Yamaha Motor Corporation, U.S.A. All rights reserved.



Part List

PROV150LH 1987 / TOP COWLING

REF - NO	PART NUMBER	PART NAME	QUANTITY	REMARKS
1	6J9-42610-40-EK	TOP COWLING ASSEMBLY	1	
2	6E5-42647-00-94	.HOLDER, CLAMP BAND	1	
3	6E5-42649-01-94	.HOLDER, CLAMP BAND	2	
4	663-42662-00-00	.DAMPER	3	
5	90266-06M02-00	.RIVET	3	
6	90266-06M02-00	.RIVET	6	
7	6E5-42652-00-00	.HOOK	2	
8	688-42652-10-00	.HOOK	1	
9	97395-06016-00	.BOLT	6	
10	92990-06600-00	.WASHER, PLATE	6	
11	6E5-42617-00-00	.DAMPER, FORM	1	
12	6J9-42619-00-00	.RUBBER, FORM 2	1	
13	6J9-42627-00-00	.RUBBER, FORM 3	1	
14	6E5-42615-00-00	.SEAL	1	
15	6J9-42620-00-EK	.AIR DUCT ASSEMBLY	1	
16	92990-06600-00	.WASHER, PLATE	4	
17	95380-06600-00	.NUT, HEXAGON	4	
18	6J9-42686-00-00	.EMBLEM, FRONT	1	
19	90183-05M01-00	.NUT, SPRING	7	
20	6J9-42687-00-00	.EMBLEM, REAR	1	
21	90183-05M01-00	.NUT, SPRING	6	
22	6J9-42688-00-00	.EMBLEM, SIDE 1	1	
23	6J9-42689-00-00	.EMBLEM, SIDE 2	1	
24	90183-05M01-00	.NUT, SPRING	8	
25	6J9-42622-00-00	.DAMPER	1	
26	6J9-W0070-00-00	.GRAPHIC SET	1	
27	6J9-42678-00-00	.GRAPHIC, REAR	1	
28	6J9-42681-00-00	.MARK, COWLING 1	1	
29	6J9-42682-00-00	.MARK, COWLING 2	1	
30	90183-05M01-00	.NUT, SPRING	6	
31	6J9-42683-00-00	.MARK, COWLING 3 (6J9-42685-00)	1	

Part Notes

PROV150LH 1987 / TOP COWLING

PART NUMBER		NOTE TEXT
92990-06600-00		OEM: This part number is among the Top 100 Most Popular Marine Maintenance Parts as of August 2013.
92990-06600-00		OEM: This part number is among the Top 100 Most Popular Marine Maintenance Parts as of August 2013.

©2013 Yamaha Motor Corporation, U.S.A. All rights reserved.

PROV150LH 1987 / BOTTOM COWLING

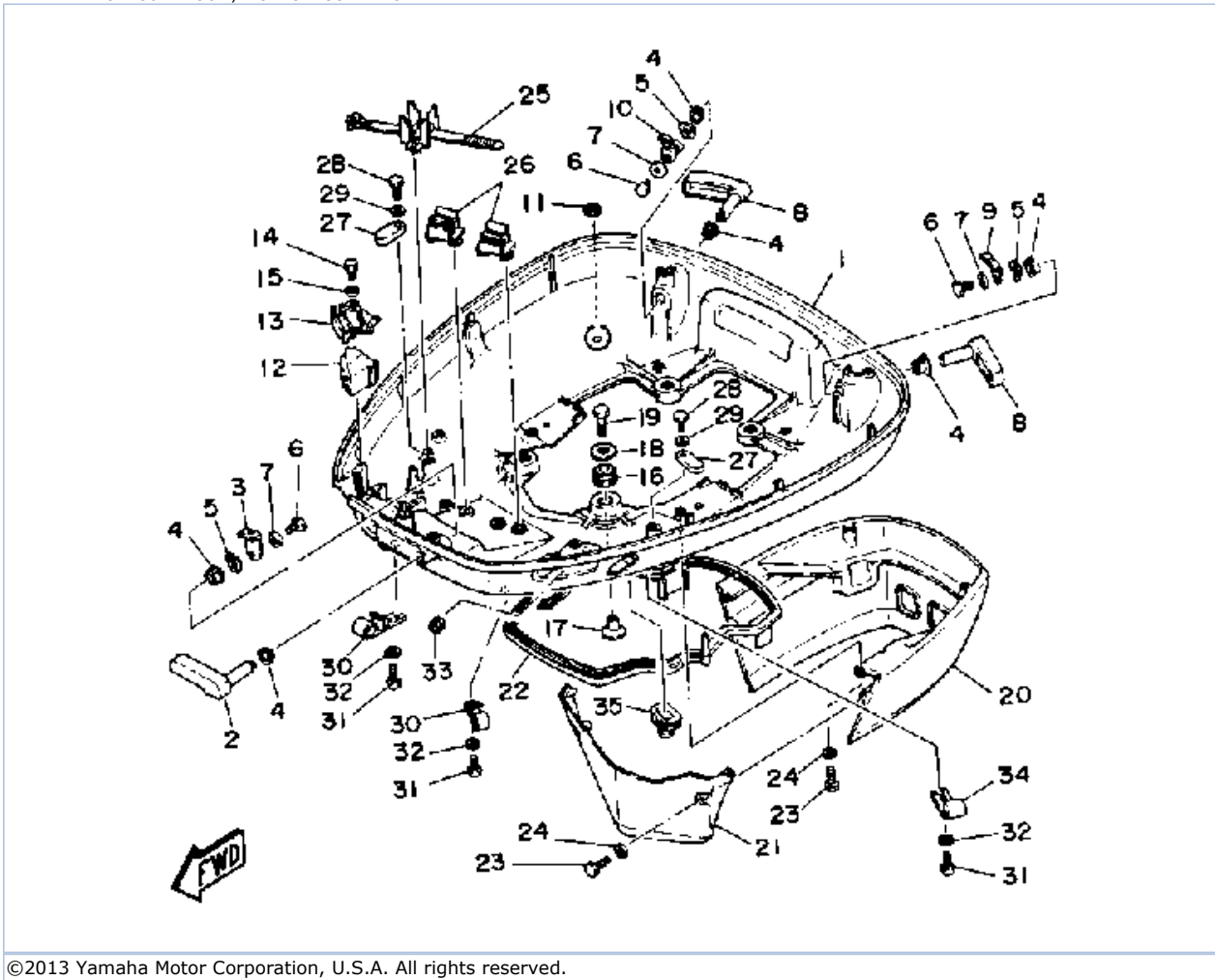

©2013 Yamaha Motor Corporation, U.S.A. All rights reserved.





Part List

PROV150LH 1987 / BOTTOM COWLING

REF - NO	PART NUMBER	PART NAME	QUANTITY	REMARKS
1	6E5-W4271-41-EK	COWLING, BOTTOM	1	
2	688-42815-00-EK	LEVER, CLAMP	1	
3	688-42816-00-00	LEVER, CLAMP	1	
4	90386-13M38-00	BUSH	6	
5	90206-13M10-00	WASHER, WAVE	3	
6	97395-06012-00	BOLT	3	
7	90201-06072-00	.WASHER, PLATE	3	
8	6E5-42817-00-EK	LEVER, CLAMP 3	2	
9	6G5-42816-00-00	LEVER, CLAMP	1	
10	6E5-42816-01-00	LEVER, CLAMP	1	
11	6E5-44391-00-00	NIPPLE, HOSE	1	
12	6E5-42725-11-00	GROMMET	1	
13	6E5-42738-00-5B	PLATE, FITTING	1	
14	97313-06016-00	BOLT, HEXAGON	2	
15	92990-06600-00	WASHER, PLATE	2	
16	90480-22M15-00	GROMMET	4	
17	90387-08M37-00	COLLAR	4	
18	90201-08M54-00	WASHER, PLATE	4	
19	97090-08035-00	BOLT	4	
20	6E5-42741-00-EK	APRON	1	
21	6E5-42771-00-EK	APRON	1	
22	6E5-42716-00-00	RUBBER, SEAL 1	1	
23	97395-06020-00	BOLT, HEXAGON	6	
24	92990-06600-00	WASHER, PLATE	6	
25	688-82594-00-00	CLAMP	1	
26	6E5-82594-00-00	CLAMP	2	
27	6E5-82588-00-00	PLATE	2	
28	97313-06020-00	BOLT, HEXAGON	2	
29	92990-06600-00	WASHER, PLATE	2	
30	6E5-24367-01-00	CLAMP, FUEL PIPE 2	2	
31	90157-06M01-00	SCREW, PAN HEAD	3	
32	92990-06600-00	WASHER, PLATE	3	
33	90480-13M24-00	GROMMET	1	
34	6E5-24367-10-00	CLAMP, FUEL PIPE 2	1	
35	688-42726-10-00	GROMMET	1	

Part Notes

PROV150LH 1987 / BOTTOM COWLING

PART NUMBER	NOTE TEXT
92990-06600-00	 OEM: This part number is among the Top 100 Most Popular Marine Maintenance Parts as of August 2013.
92990-06600-00	 OEM: This part number is among the Top 100 Most Popular Marine Maintenance Parts as of August 2013.
92990-06600-00	 OEM: This part number is among the Top 100 Most Popular Marine Maintenance Parts as of August 2013.
92990-06600-00	 OEM: This part number is among the Top 100 Most Popular Marine Maintenance Parts as of August 2013.

©2013 Yamaha Motor Corporation, U.S.A. All rights reserved.

PROV150LH 1987 / BRACKET

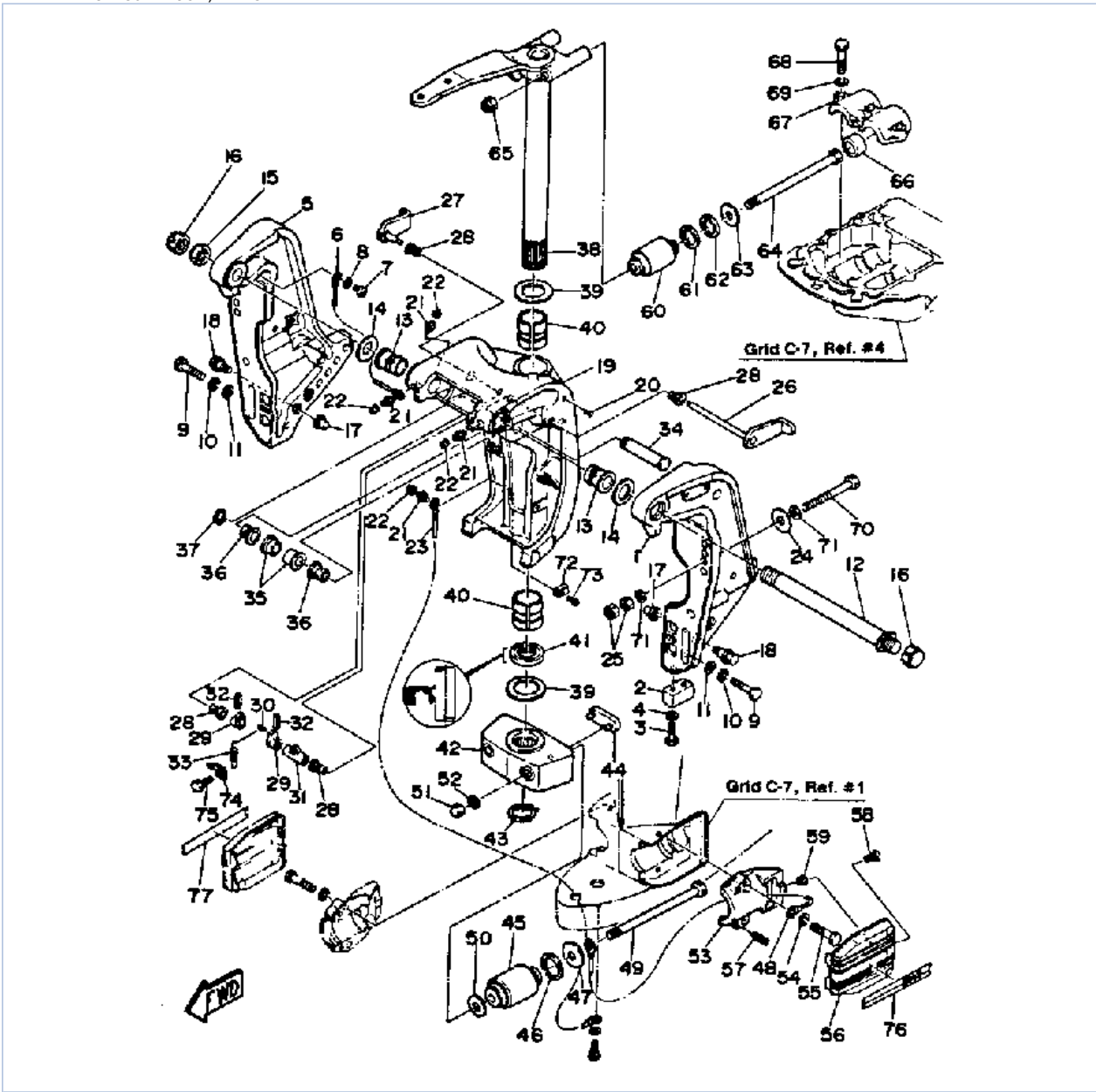

©2013 Yamaha Motor Corporation, U.S.A. All rights reserved.

Part List





PROV150LH 1987 / BRACKET

REF - NO	PART NUMBER	PART NAME	QUANTITY	REMARKS
1	6G5-43111-01-EK	BRACKET CLAMP	1	
2	6E5-45251-00-00	ANODE	1	
3	97395-06025-00	BOLT	2	
4	92990-06600-00	WASHER, PLATE	2	
5	6G5-43112-01-EK	BRACKET, CLAMP	1	
6	6E5-82148-00-00	WIRE, LEAD 4	1	
7	97890-06012-00	SCREW, PAN HEAD	1	
8	92990-06600-00	WASHER, PLATE	1	
9	97395-10050-00	BOLT	6	
10	92990-10100-00	WASHER, SPRING	6	
11	92990-10600-00	WASHER, PLATE	6	
12	6E5-43131-01-00	BOLT, CLAMP BRACKET	1	
13	90386-25M31-00	BUSH	2	
14	90201-26M59-00	WASHER, PLATE	2	
15	90185-22043-00	NUT, SELF-LOCKING	1	
16	6G5-43145-00-00	CAP, CLAMP BRACKET	2	
17	6G5-43164-00-00	ROD, TILT LOCK	2	
18	90109-12M35-00	BOLT	2	
19	6G5-43311-00-EK	BRACKET, SWIVEL	1	
20	90269-03010-00	RIVET	1	
21	93700-06M03-00	NIPPLE, GREASE	5	
22	663-45119-00-00	CAP, GREASE NIPPLE	5	
23	6E5-82147-00-00	WIRE, LEAD 5	1	
24	90201-12426-00	WASHER, PLATE	4	
25	95380-12600-00	NUT	8	
26	6G5-43181-02-00	LEVER, TILT STOP 1	1	
27	6G5-43185-02-00	LEVER, TILT STOP 2	1	
28	90386-10M16-00	BUSH	4	
29	6G5-43148-00-00	COLLAR, DISTANCE	2	
30	90249-06M19-00	PIN	1	
31	90387-10M02-00	COLLAR	1	
32	91690-30020-00	PIN, SPRING	2	
33	90506-14M24-00	SPRING, TENSION	1	
34	6E5-43126-02-00	PIN, UPPER SHOCK MOUNT	1	
35	90386-18M63-00	BUSH	2	
36	90386-18M14-00	BUSH	2	
37	93410-18M02-00	CIRCLIP	1	
38	6E5-42510-03-EK	STEERING BRACKET ASSY	1	
39	90201-38M60-00	WASHER, PLATE	2	
40	90386-38M32-00	BUSH	2	
41	93109-38M02-00	OIL SEAL	1	
42	6G5-44551-00-EK	HOUSING, LOWER MOUNT	1	
43	93410-37M04-00	CIRCLIP	1	
44	6E5-44575-00-00	DAMPER, LOWER MOUNT RUBBER	1	
45	6J9-44555-00-94	MOUNT DAMPER, LOWER SIDE	2	
46	90202-32M19-00	WASHER, PLATE	2	
47	90201-16M55-00	WASHER, PLATE	2	
48	6E5-82149-00-00	WIRE, LEAD 3	1	
49	90109-14M34-00	BOLT	2	
50	90201-15M58-00	WASHER, PLATE	2	
51	95380-14800-00	NUT	2	
52	92990-14600-00	WASHER	2	

53	6E5-44552-01-94	HOUSING, LOWER MOUNT RUBBER	2	
54	92990-10100-00	WASHER, SPRING	4	
55	97395-10045-00	BOLT	4	
56	6J9-44553-00-NG	COVER, LWR.MOUNT	2	
57	90501-16M28-00	SPRING, COMPRESSION	4	
58	90159-06M05-00	SCREW, WITH WASHER	2	
59	90179-06066-00	NUT	2	
60	6J9-44514-00-94	MOUNT DAMPER, UPPER SIDE	2	
61	90201-26M57-00	WASHER, PLATE	2	
62	90202-26M18-00	WASHER, PLATE	2	
63	90201-14M56-00	WASHER, PLATE	2	
64	90109-12M37-00	BOLT	2	
65	90185-12058-00	NUT, SELF-LOCKING	2	
66	663-44575-00-00	DAMPER, LOWER MOUNT RUBBER	2	
67	6E5-44511-00-5B	COVER, UPPER MOUNT	1	
68	97395-10045-00	BOLT	3	
69	92990-10100-00	WASHER, SPRING	3	
70	90101-12M03-00	BOLT (L:115MM)	4	U.R.
70	90101-12M05-00	BOLT (L:130MM)	4	U.R.
71	92990-12200-00	WASHER, PLAIN	8	
72	90464-11M18-00	CLAMP	1	
73	98580-04008-00	.SCREW, PAN HEAD	1	
74	6G5-43144-00-00	HOOK, SPRING	1	
75	97395-06010-00	BOLT	1	
76	6J9-43155-00-00	MARK 1	1	
77	6J9-43156-00-00	MARK 2	1	

Part Notes

PROV150LH 1987 / BRACKET

PART NUMBER		NOTE TEXT
92990-06600-00		OEM: This part number is among the Top 100 Most Popular Marine Maintenance Parts as of August 2013.
92990-06600-00		OEM: This part number is among the Top 100 Most Popular Marine Maintenance Parts as of August 2013.
92990-10600-00		OEM: This part number is among the Top 100 Most Popular Marine Maintenance Parts as of August 2013.
93700-06M03-00		OEM: This part number is among the Top 100 Most Popular Marine Maintenance Parts as of August 2013.

©2013 Yamaha Motor Corporation, U.S.A. All rights reserved.

PROV150LH 1987 / POWER TRIM TILT SENDER

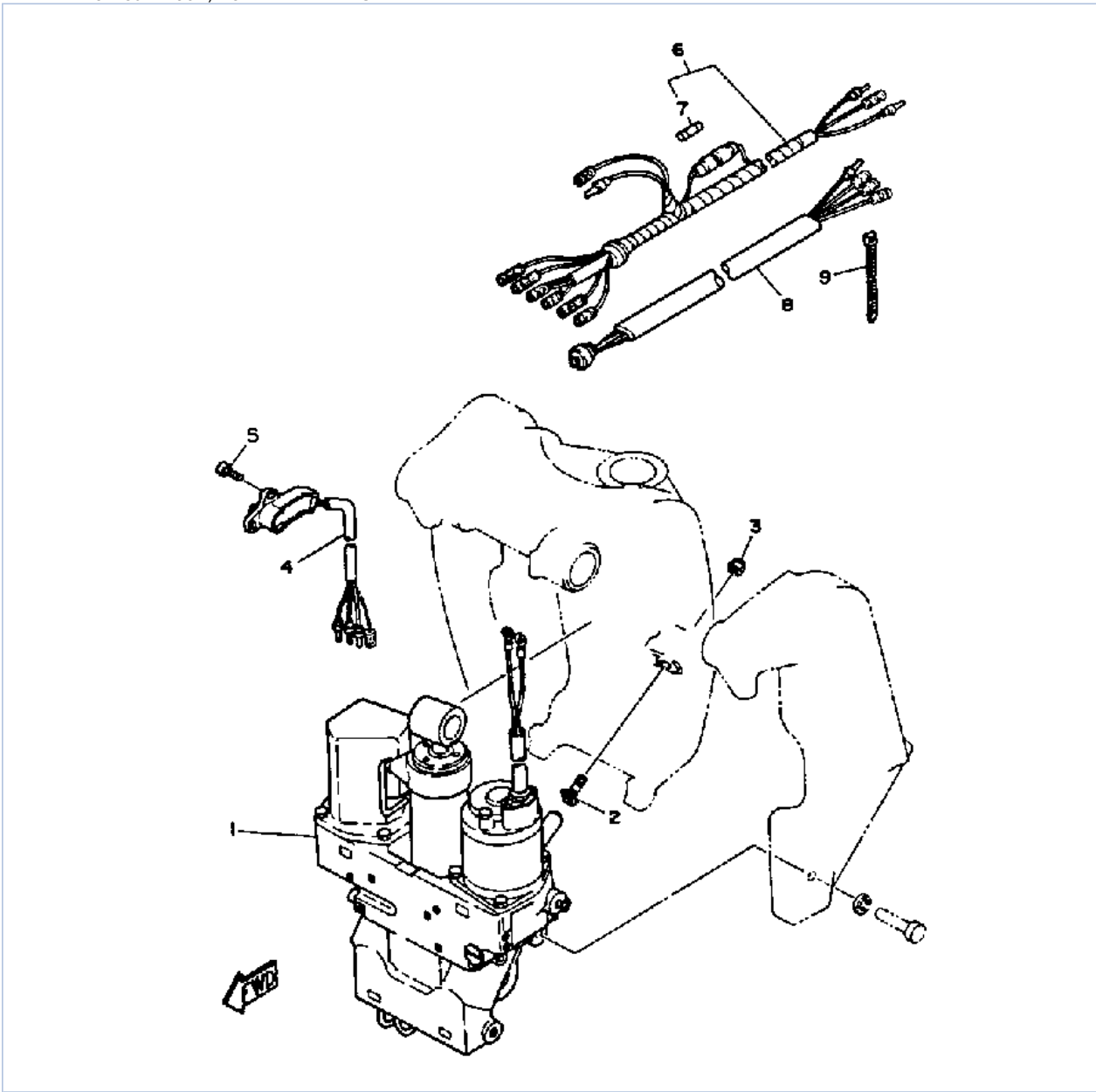

©2013 Yamaha Motor Corporation, U.S.A. All rights reserved.

Part List

PROV150LH 1987 / POWER TRIM TILT SENDER

REF - NO	PART NUMBER	PART NAME	QUANTITY	REMARKS
1	6G5-43800-02-EK	POWER TRIM TILT ASSY	1	
2	6G5-43376-00-00	BOLT, THRUST RECEIVER	2	
3	95780-10300-00	NUT, FLANGE	2	
4	6G5-83672-00-00	TRIM SENDER	1	
5	98580-06016-00	SCREW, PAN HEAD	2	
6	6Y5-83553-00-00	WIRE, LEAD (L=2.5M)	1	
7	1E6-82151-00-00	.FUSE (10A)	1	
8	6E5-82553-10-00	EXTENSION, WIRE HARNESS	1	
9	90465-11M10-00	CLAMP	3	

PROV150LH 1987 / POWER TRIM TILT ASSY

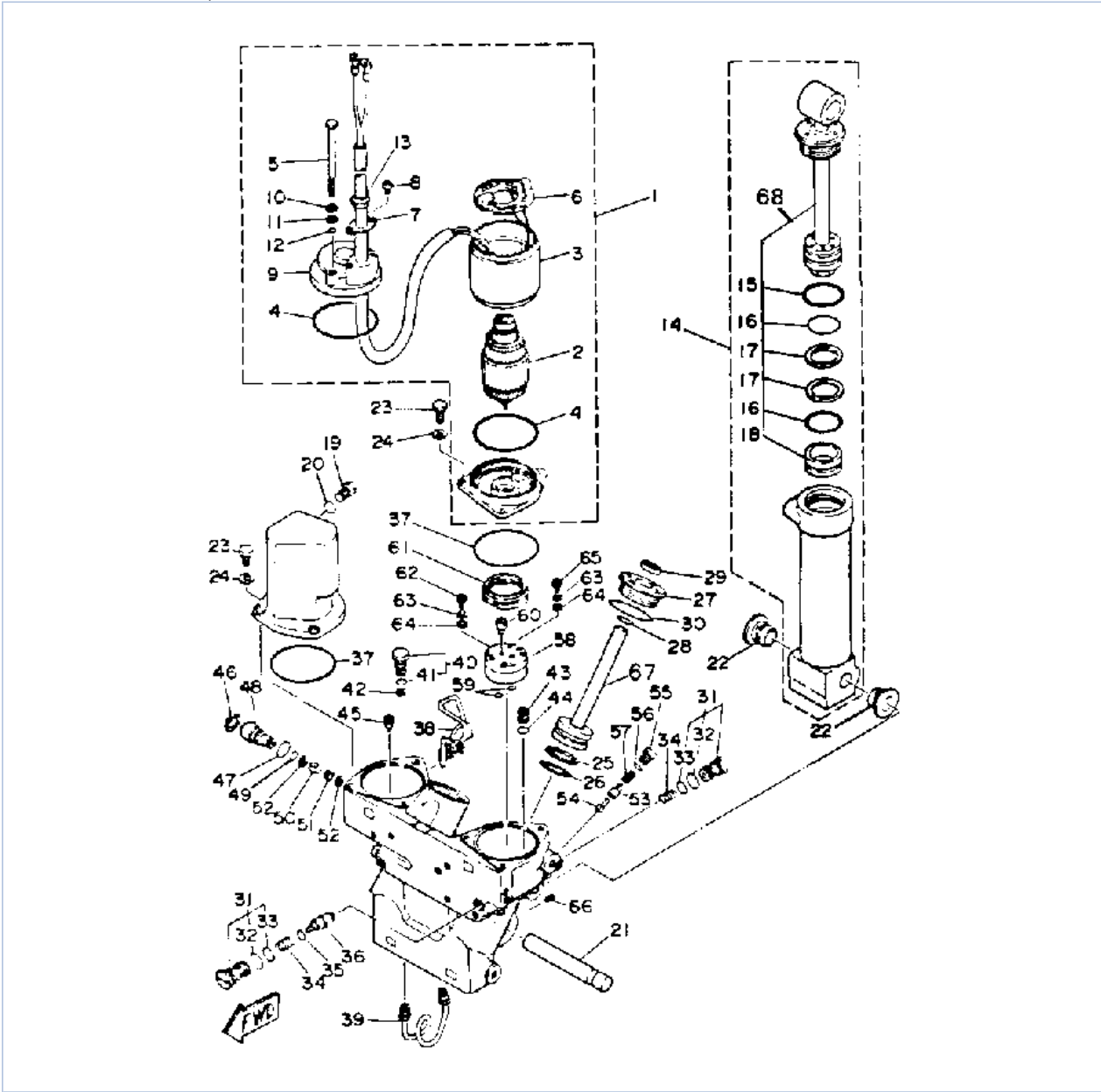

©2013 Yamaha Motor Corporation, U.S.A. All rights reserved.

Part List

PROV150LH 1987 / POWER TRIM TILT ASSY

REF - NO	PART NUMBER	PART NAME	QUANTITY	REMARKS
1	6G5-43880-01-00	.MOTOR ASSEMBLY	1	
2	6G5-43805-00-00	..ARMATURE ASSY	1	
3	6G5-43804-00-00	..STATOR ASSY	1	
4	6G5-43865-00-00	..O-RING	2	
5	6G5-43887-00-00	..BOLT, THROUGH	2	
6	6G5-43806-00-00	..BRUSH, HOLDER ASSY	1	
7	6G5-43899-00-00	..PLATE, STOPPER	1	
8	6G5-43886-00-00	..BOLT	2	
9	6G5-43884-00-00	..FRAME, COMMUTATOR END	1	
10	6G5-43893-00-00	..WASHER	2	
11	6G5-43889-10-00	..PLATE SEAT	2	
12	6G5-43867-00-00	..O-RING	2	
13	6G5-43885-00-00	..GROMMET	1	
14	6G5-4380E-01-00	.TILT CYLINDER ASSEMBLY	1	
15	6E5-43861-00-00	..O-RING	1	
16	6G5-43862-00-00	..O-RING	2	
17	6E5-43872-00-00	..RING, BACK UP	2	
18	6E5-43814-01-00	..PISTON, FREE	1	
19	6E5-43829-00-00	.PLUG, RESERVOIR	1	
20	6E5-43863-00-00	.O-RING	1	
20	6G5-43800-02-EK	POWER TRIM TILT ASSY	1	
21	6G5-43818-00-00	.PIN, LOWER SHOCK MOUNT	1	
22	90386-18M14-00	.BUSH	2	
22	6G5-W0094-01-00	POWER TRIM & TILT REPAIR KIT	1	
23	(90101-06M85-00)	BOLT	6	
24	90209-06M09-00	.WASHER	6	
25	6G5-43874-00-00	.RING, BACK UP	2	
26	6G5-43864-00-00	.O-RING	2	
27	6G5-43821-01-00	.SCREW, TRIM CYLINDER END (6G5-43821-00-00)	2	
28	6E5-43865-00-00	.O-RING	2	
29	6E5-43822-01-00	.SEAL, TRIM DUST	2	
30	6G5-43861-00-00	.O-RING	2	
31	6G5-43802-00-00	.VALVE SUB ASSEMBLY (MN)	2	
32	6E5-43866-00-00	..O-RING	1	
33	6E5-43867-00-00	..O-RING	1	
34	6G5-43894-00-00	.SPRING, SHUTTLE RETURN	2	
35	6E5-43868-00-00	.O-RING	1	
36	6G5-43841-00-00	.PISTON, SHUTTLE	1	
37	6E5-43869-00-00	.O-RING	2	
38	6G5-43835-00-00	.PIPE	1	
39	6G5-43833-00-00	.PIPE	1	
40	6G5-43809-00-00	.SEAT, VALVE COMP 2	1	
41	6E5-43896-00-00	..O-RING	1	
42	6G5-43816-00-00	.FILTER 1	1	
43	6G5-43808-01-00	.SEAT, VALVE COMP 1	1	
44	6E5-43883-00-00	.O-RING	1	
44	6G5-W0094-01-00	POWER TRIM & TILT REPAIR KIT	1	
45	6G5-43803-00-00	.CASE VALVE COMP	1	
46	6H1-43875-00-00	.RING, SNAP	1	
47	93210-18M75-00	.O-RING	1	
48	6G5-43845-00-00	.SCREW, MANUAL RELEASE	1	

49	93210-10M74-00	.O-RING	1	
50	6E5-4382A-00-00	.ADAPTER 1	1	
51	6E5-43854-01-00	.SPRING, MANUAL RELEASE	1	
52	6E5-43847-00-00	.SEAT, MANUAL VALVE	2	
53	6G5-43849-00-00	.PIN, VALVE SUPPORT	1	
54	6G5-4381A-00-00	.SHAFT	1	
55	6G5-43842-00-00	.SCREW, VALVE SEAT	1	
56	6G5-43866-00-00	.O-RING	1	
57	6E5-43824-01-00	.SPRING, COMPRESSION	1	
58	6G5-43830-00-00	.GEAR PUMP ASSY	1	
59	6G5-43863-00-00	.O-RING	2	
60	6G5-43831-00-00	.CONNECTOR, SHAFT	1	
61	6E5-43817-10-00	.FILTER 2	1	
62	6G5-43878-01-00	.BOLT, SOCKET	2	
63	90209-05M10-00	.WASHER	3	
64	90201-05M00-00	.WASHER, PLATE	3	
65	6G5-43888-01-00	.BOLT, SOCKET	1	
66	6G5-43878-10-00	.BOLT, SOCKET	1	
67	6G5-43820-01-00	.PISTON SUB ASSEMBLY	2	
68	6G5-W0094-01-00	POWER TRIM & TILT REPAIR KIT	1	
68	6G5-43810-00-00	.PISTON SUB ASSEMBLY	1	

Part Notes

PROV150LH 1987 / POWER TRIM TILT ASSY

PART NUMBER	NOTE TEXT
6G5-43864-00-00 	OEM: This part number is among the Top 100 Most Popular Marine Maintenance Parts as of August 2013.

©2013 Yamaha Motor Corporation, U.S.A. All rights reserved.

PROV150LH 1987 / CONTROL ENGINE

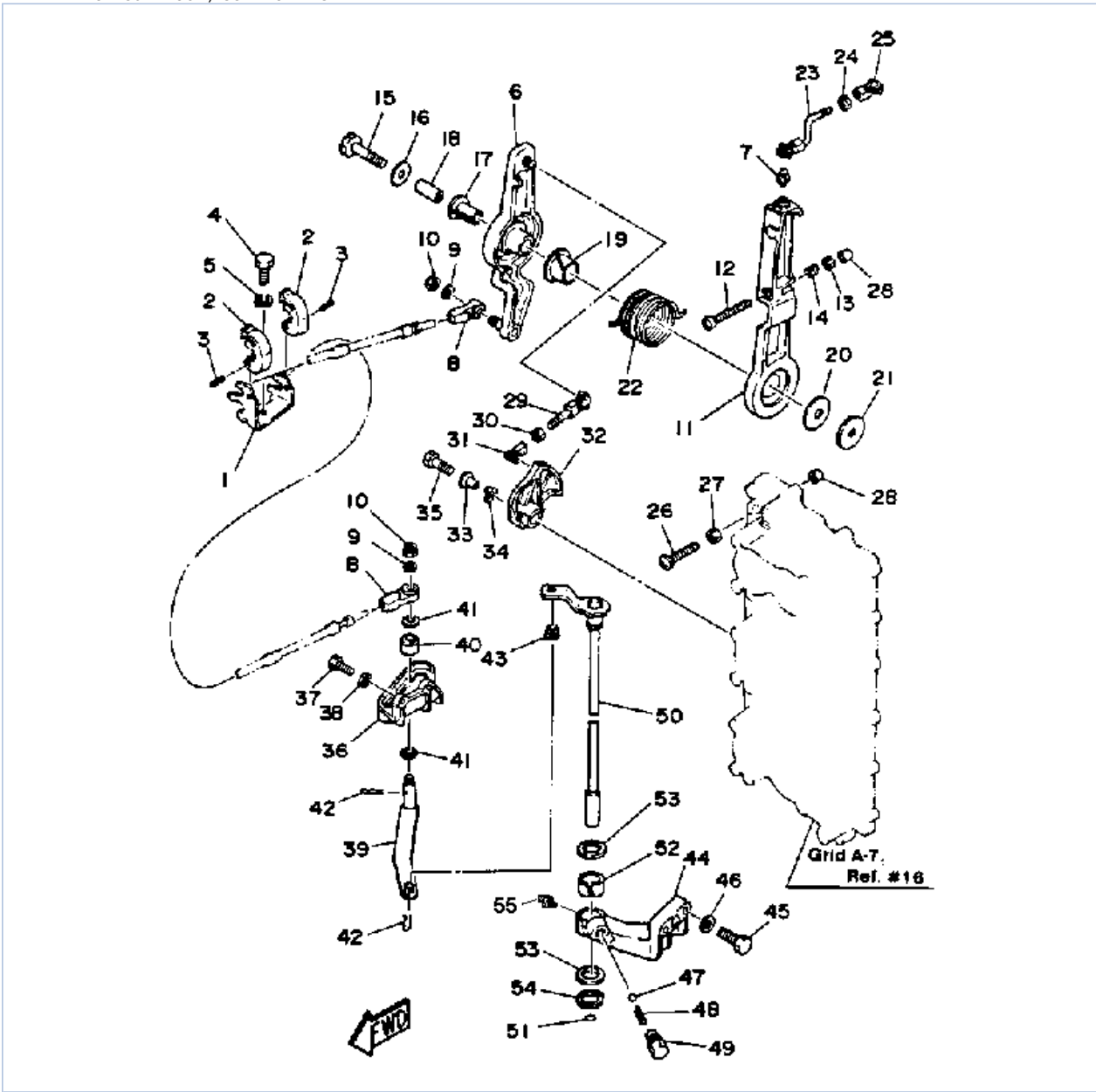

©2013 Yamaha Motor Corporation, U.S.A. All rights reserved.

Part List





PROV150LH 1987 / CONTROL ENGINE

REF - NO	PART NUMBER	PART NAME	QUANTITY	REMARKS
1	6E5-48531-00-00	BRACKET, REMOTE CONTROL 1	1	
2	6E5-48538-00-00	CLAMP, CABLE	2	
3	91690-30012-00	PIN, SPRING	2	
4	97313-08020-00	BOLT, HEXAGON	1	
5	92990-08100-00	WASHER, SPRING	1	
6	61H-41632-00-94	LEVER, MAGNETO CONTROL (6G5-41632-01-94)	1	
7	663-85518-00-00	JOINT, BALL	1	
8	6E5-48344-00-00	CABLE END, REMOTE CONTROL	2	
9	92990-06200-00	..WASHER, PLAIN	2	
10	90185-06062-00	NUT, SELF-LOCKING	2	
11	6J9-41631-00-94	LEVER, MAGNETO CONTMAGNETO CONTROL	1	
12	90157-06M11-00	SCREW, PAN HEAD	1	
13	95380-06600-00	NUT, HEXAGON	1	
14	90501-16M12-00	SPRING, COMPRESSION	1	
15	97313-08045-00	BOLT, HEXAGON	1	
16	90201-08M54-00	WASHER, PLATE	1	
17	90386-12089-00	BUSH	1	
18	90387-08M16-00	COLLAR	1	
19	90386-22M13-00	BUSH	1	
20	90202-12092-00	WASHER, PLATE	1	
21	90201-08M13-00	WASHER, PLATE	1	
22	90508-29M12-00	SPRING, TORSION	1	
23	6G5-41636-01-00	ROD, MAGNETO CONTROL	1	
24	95380-05600-00	NUT	1	
25	6H1-41237-00-00	JOINT, LINK	1	
26	90157-06M13-00	SCREW, PAN HEAD	1	
27	95380-06600-00	NUT, HEXAGON	1	
28	688-44194-00-00	CAP	2	
29	6G5-41211-01-00	LINK, ACCEL.	1	
30	95380-05600-00	NUT	1	
31	6H1-41237-00-00	JOINT, LINK	1	
32	6J9-41213-00-00	CAM ACCEL.	1	
33	90387-06M29-00	COLLAR	1	
34	90206-10M04-00	WASHER, WAVE	1	
35	97313-06025-00	BOLT	1	
36	6E5-44117-00-94	BRACKET	1	
37	97313-06020-00	BOLT, HEXAGON	2	
38	92990-06600-00	WASHER, PLATE	2	
39	6E5-44121-00-00	LEVER, SHIFT ROD	1	
40	6E5-44122-00-00	BUSHING, SHIFT ROD LEVER	1	
41	90202-08M20-00	WASHER, PLATE	2	
42	90468-18008-00	CLIP	2	
43	90386-06M12-00	BUSH	1	
44	6E5-44118-01-94	BRACKET	1	SEE NOTE
44	6E5-44118-01-94	BRACKET	1	
45	97313-08030-00	BOLT	2	
46	92990-08600-00	.WASHER, PLATE	2	
47	93501-04M02-00	BALL	1	
48	90501-12082-00	SPRING, COMPRESSION	1	
49	648-42715-00-00	BUSHING	1	
50	6E5-44120-02-00	HANDEL, GEAR SHIFT	1	

		ASSEMBLY		
51	93210-09350-00	O-RING	1	
52	90386-16M66-00	BUSH	1	
52	90380-16M66-00	UNAVAILABLE IN PRICE BOOK	1	SEE NOTE
53	90202-16061-00	WASHER, PLATE	2	
54	99009-16400-00	CIRCLIP	1	
55	93700-06M03-00	NIPPLE, GREASE	1	SEE NOTE

Part Notes

PROV150LH 1987 / CONTROL ENGINE

PART NUMBER		NOTE TEXT
6H1-41237-00-00		OEM: This part number is among the Top 100 Most Popular Marine Maintenance Parts as of August 2013.
6H1-41237-00-00		OEM: This part number is among the Top 100 Most Popular Marine Maintenance Parts as of August 2013.
92990-06600-00		OEM: This part number is among the Top 100 Most Popular Marine Maintenance Parts as of August 2013.
93700-06M03-00		OEM: This part number is among the Top 100 Most Popular Marine Maintenance Parts as of August 2013.

©2013 Yamaha Motor Corporation, U.S.A. All rights reserved.

PROV150LH 1987 / UPPER CASING

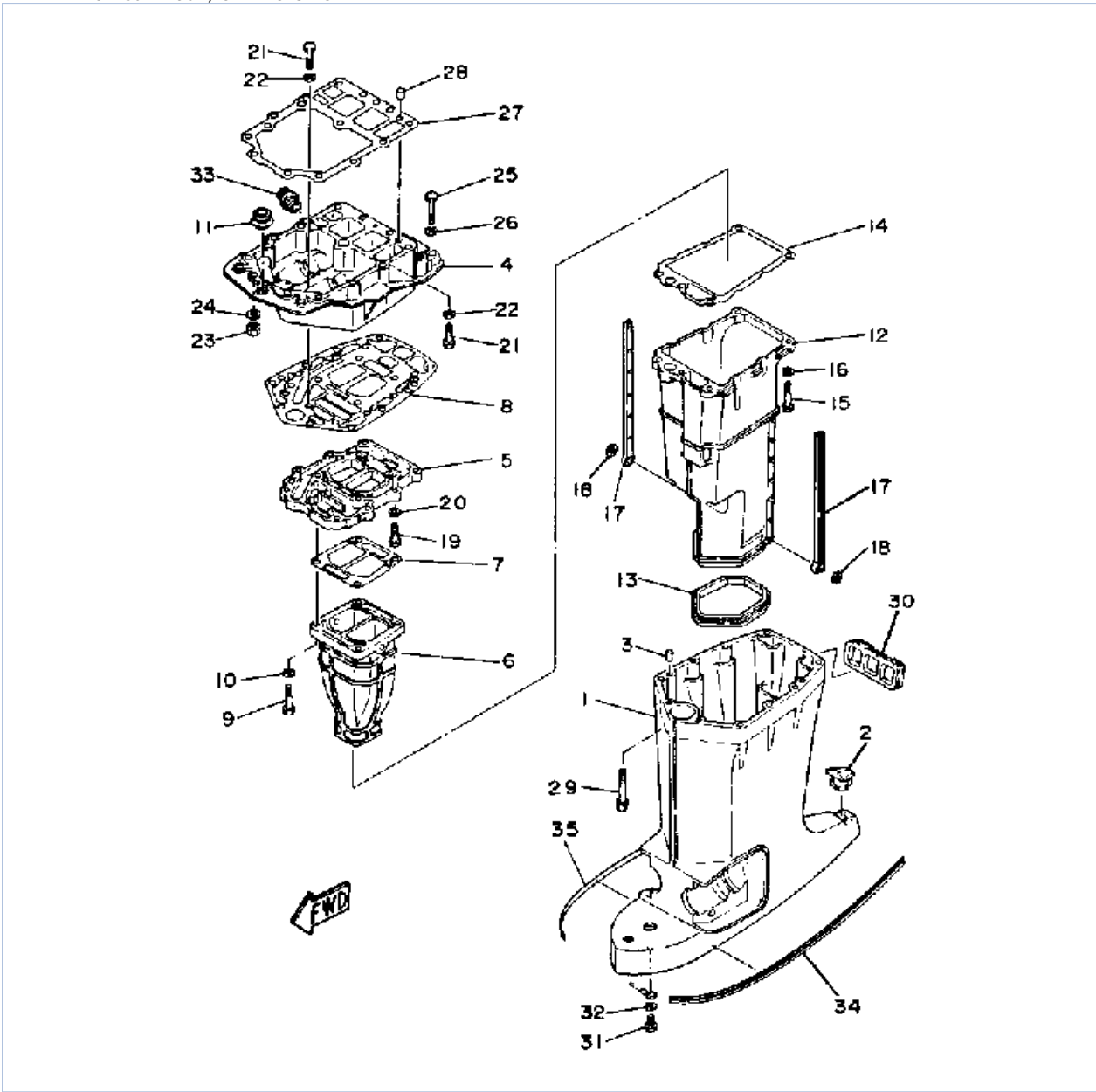

©2013 Yamaha Motor Corporation, U.S.A. All rights reserved.

Part List

PROV150LH 1987 / UPPER CASING

REF - NO	PART NUMBER	PART NAME	QUANTITY	REMARKS
1	6E5-45111-00-EK	CASING, UPPER	1	
2	6E5-45155-00-00	CAP	1	
3	93608-12M05-00	PIN, DOWEL	2	
4	6G5-41137-00-94	GUIDE, EXHAUST	1	
5	6G5-41131-00-5B	MANIFOLD, EXHAUST 1 (6G5-41131-00-9M)	1	
6	6J9-41132-00-5B	MANIFOLD, EXHAUST	1	
7	6G5-41134-00-00	GASKET, EXHAUST MANIFOLD	1	
8	6G5-45114-00-00	GASKET, UPPER CASING	1	
9	97395-08045-00	BOLT	4	
10	92990-08600-00	.WASHER, PLATE	4	
11	6E5-42724-00-00	GROMMET	1	
12	6E5-14711-00-5B	MUFFLER 1 (6E5-14711-00- 9M)	1	
13	6E5-45123-00-00	.GASKET, MUFFLER	1	
14	6E5-41135-00-00	GASKET, EXHAUST MANIFOLD	1	
15	97395-08045-00	BOLT	5	
16	92990-08600-00	.WASHER, PLATE	5	
17	6E5-14737-00-00	DAMPER, MUFFLER	2	
18	90183-05M02-00	NUT, SPRING	2	
19	97395-08030-00	BOLT	4	
20	92990-08600-00	.WASHER, PLATE	4	
21	97395-08030-00	BOLT	6	
22	92990-08100-00	WASHER, SPRING	6	
23	95380-08700-00	NUT	2	
24	92990-08100-00	WASHER, SPRING	2	
25	97395-08045-00	BOLT	2	
26	92990-08100-00	WASHER, SPRING	2	
27	6G5-45113-A0-00	GASKET, UPPER CASING	1	
28	93608-12M05-00	PIN, DOWEL	2	
29	90119-08M78-00	BOLT, WITH WASHER	6	
30	6E5-42769-00-00	SEAL, RUBBER	1	
31	97395-06010-00	BOLT	1	
32	92990-06600-00	WASHER, PLATE	1	
33	6G5-12581-00-00	JOINT, HOSE 1	1	
34	6J9-42791-00-00	MARK	1	
35	6J9-42792-00-00	MARK 2	1	

Part Notes

PROV150LH 1987 / UPPER CASING

PART NUMBER	NOTE TEXT
92990-06600-00 	OEM: This part number is among the Top 100 Most Popular Marine Maintenance Parts as of August 2013.

©2013 Yamaha Motor Corporation, U.S.A. All rights reserved.

PROV150LH 1987 / LOWER DRIVE 1

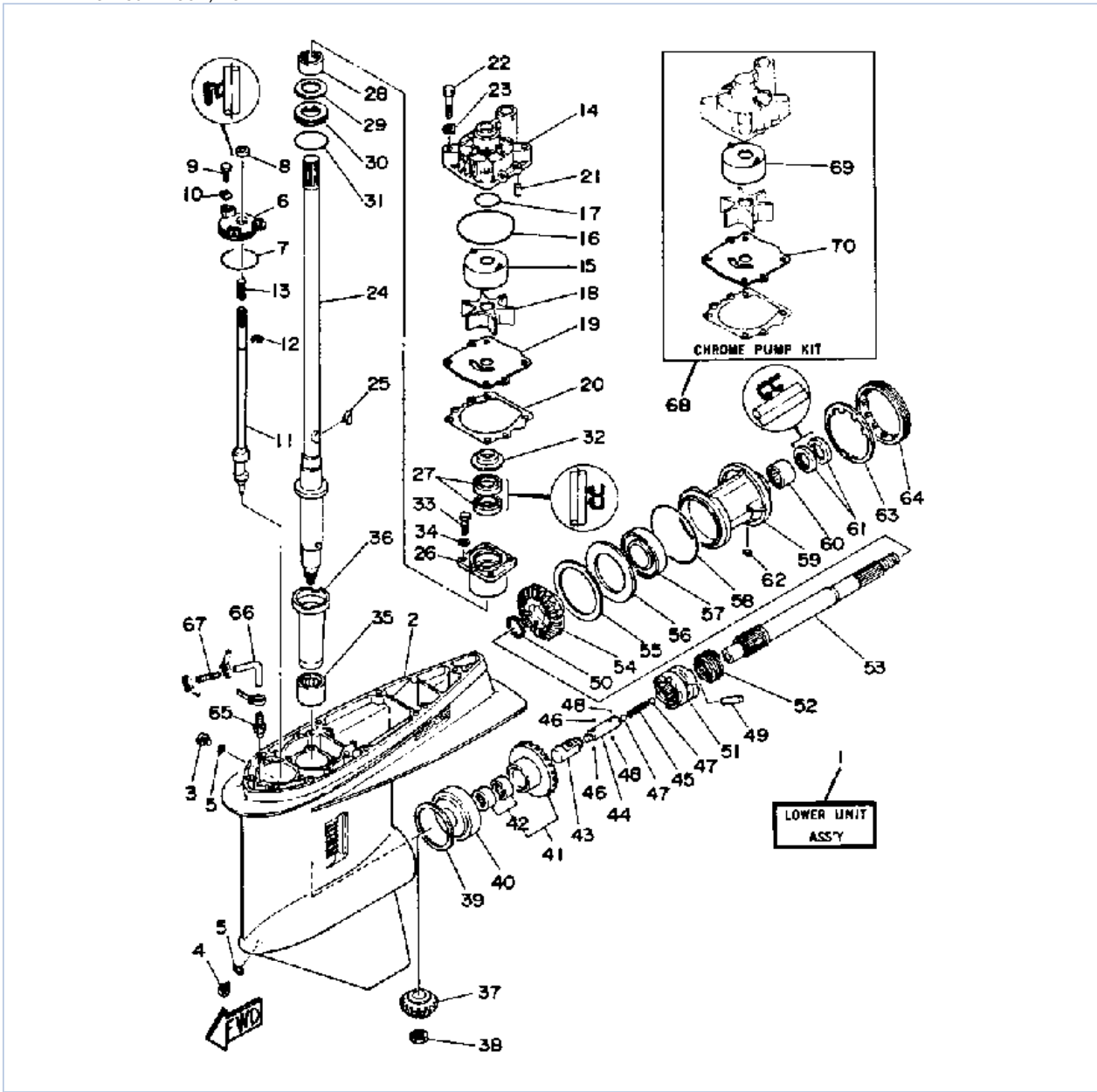

©2013 Yamaha Motor Corporation, U.S.A. All rights reserved.

Part List







PROV150LH 1987 / LOWER DRIVE 1

REF - NO	PART NUMBER	PART NAME	QUANTITY	REMARKS
1	99999-02263-00	LOWER UNIT/COVR KT (6J9-45300-12-NA) (REF. #2~71)	1	
2	90282-04M00-00	KEY, STRAIGHT	1	
2	99999-02261-00	LWR CASING/MT CVRS	1	
2	99999-02261-00	LWR CASING/MT CVRS	1	
3	90340-08M04-00	PLUG, STRAIGHT SCREW	1	
4	688-45341-00-00	PLUG, DRAIN	1	
5	90430-08020-00	.GASKET	2	
6	6E5-45321-00-00	PLATE	1	
7	93210-58677-00	.O-RING	1	
8	93106-09014-00	.OIL SEAL	1	
9	97395-06020-00	.BOLT, HEXAGON	3	
10	90209-06M04-00	WASHER	3	
11	6G5-44150-01-00	SHIFT CAM ASSY	1	
12	99001-08600-00	CIRCLIP	1	
13	90501-11M10-00	SPRING, COMPRESSION	1	
14	6E5-44311-00-00	HOUSING, WATER PUMP	1	
15	6E5-44322-00-00	INSERT, CARTRIDGE	1	
16	93210-86M38-00	.O-RING	1	
17	93210-37M67-00	O-RING	1	
18	6E5-44352-00-00	.IMPELLER	1	
19	6G5-44323-00-00	.OUTER PLATE, CARTRIDGE	1	
20	6E5-44315-00-00	GASKET, WATER PUMP	1	
21	93606-12019-00	.PIN, DOWEL	1	
22	97395-08045-00	.BOLT	4	
23	90209-08M02-00	WASHER	4	
24	6G5-45501-01-00	DRIVE SHAFT COMP.	1	
25	90280-04M05-00	.KEY, WOODRUFF	1	
26	6E5-45331-00-94	HOUSING, BEARING	1	
27	93101-28M16-00	.OIL SEAL	2	
28	93317-330U2-00	BEARING	1	
29	6E5-45587-00-05	SHIM 3	1	U.R.
29	6E5-45587-00-08	SHIM 3	1	U.R.
29	6E5-45587-01-12	SHIM (T:0.12MM)	1	U.R.
29	6E5-45587-01-30	SHIM (T:0.30MM)	1	U.R.
29	6E5-45587-01-50	SHIM (T:0.50MM)	1	U.R.
30	93341-930U0-00	BEARING, THRUST	1	
31	93210-54534-00	.O-RING	1	
32	6E5-45344-00-00	COVER, OIL SEAL	1	
33	97395-08025-00	BOLT	4	
34	92990-08600-00	.WASHER, PLATE	4	
35	93311-928U5-00	BEARING	1	
36	6E5-45536-00-00	SLEEVE, DRIVE SHAFT	1	
37	6J9-45551-00-00	PINION	1	
38	90170-16M01-00	NUT	1	
39	6G5-45567-00-05	SHIM	1	U.R.
39	6G5-45567-00-08	SHIM	1	U.R.
39	6G5-45567-01-12	SHIM (T:0.12MM)	1	U.R.
39	6G5-45567-01-30	SHIM (T:0.30MM)	1	U.R.
39	6G5-45567-01-50	SHIM (T:0.50MM)	1	U.R.
40	93332-000V3-00	BEARING	1	
41	6J9-45560-01-00	GEAR 1 ASSEMBLY	1	
42	93315-425V3-00	.BEARING	1	
43	6E5-45641-01-00	SHIFTER	1	

44	6E5-45634-01-00	SLIDE, SHIFT	1	
45	90501-16M37-00	SPRING, COMPRESSION	1	
46	93507-32031-00	.BALL 7-32	2	
47	93511-32027-00	BALL	2	
48	93503-16010-00	..BALL 3-16	2	
49	90250-08M07-00	PIN, STRAIGHT	1	
50	90201-30M92-00	WASHER, PLATE	1	
51	6G5-45631-00-00	CLUTCH, DOG	1	
52	6E5-45633-01-00	RING, CROSS PIN	1	
53	6J9-45611-01-00	SHAFT, PROPELLER	1	
54	6J9-45571-01-00	GEAR 2	1	
55	6G5-45577-01-05	SHIM	1	U.R.
55	6G5-45577-01-08	SHIM	1	U.R.
55	6G5-45577-02-12	SHIM (T:0.12MM)	1	U.R.
55	6G5-45577-02-30	SHIM (T:0.30MM)	1	U.R.
55	6G5-45577-02-50	SHIM (T:0.50MM)	1	U.R.
56	6G5-45576-00-00	WASHER, THRUST	1	
57	93306-209U0-00	BEARING	1	
58	93210-97M55-00	.O-RING	1	
59	6J9-45332-00-94	HOUSING, BEARING	1	
60	93315-430U8-00	BEARING	1	
61	93101-30M17-00	.OIL SEAL	2	
62	90282-04010-00	KEY, STRAIGHT	1	
63	6G5-45383-01-00	WASHER, CLAW	1	
64	6G5-45384-00-00	NUT	1	
65	6E5-45378-00-00	NIPPLE, HOSE	1	
66	90445-07ME8-00	HOSE (L80)	1	
67	6E5-83558-10-00	END, NIPPLE	1	
68	6G5-W0078-0A-00	CHROME PUMP KIT	1	
69	6E5-44322-41-00	INSERT, CARTRIDGE	1	
70	6G5-44323-40-00	.OUTER PLATE, CARTRIDGE	1	

Part Notes

PROV150LH 1987 / LOWER DRIVE 1

PART NUMBER		NOTE TEXT
90430-08020-00		OEM: This part number is among the Top 100 Most Popular Marine Maintenance Parts as of August 2013.
93106-09014-00		OEM: This part number is among the Top 100 Most Popular Marine Maintenance Parts as of August 2013.
93210-86M38-00		OEM: This part number is among the Top 100 Most Popular Marine Maintenance Parts as of August 2013.
93101-28M16-00		OEM: This part number is among the Top 100 Most Popular Marine Maintenance Parts as of August 2013.
93210-54534-00		OEM: This part number is among the Top 100 Most Popular Marine Maintenance Parts as of August 2013.
93101-30M17-00		OEM: This part number is among the Top 100 Most Popular Marine Maintenance Parts as of August 2013.

©2013 Yamaha Motor Corporation, U.S.A. All rights reserved.

PROV150LH 1987 / LOWER DRIVE 2

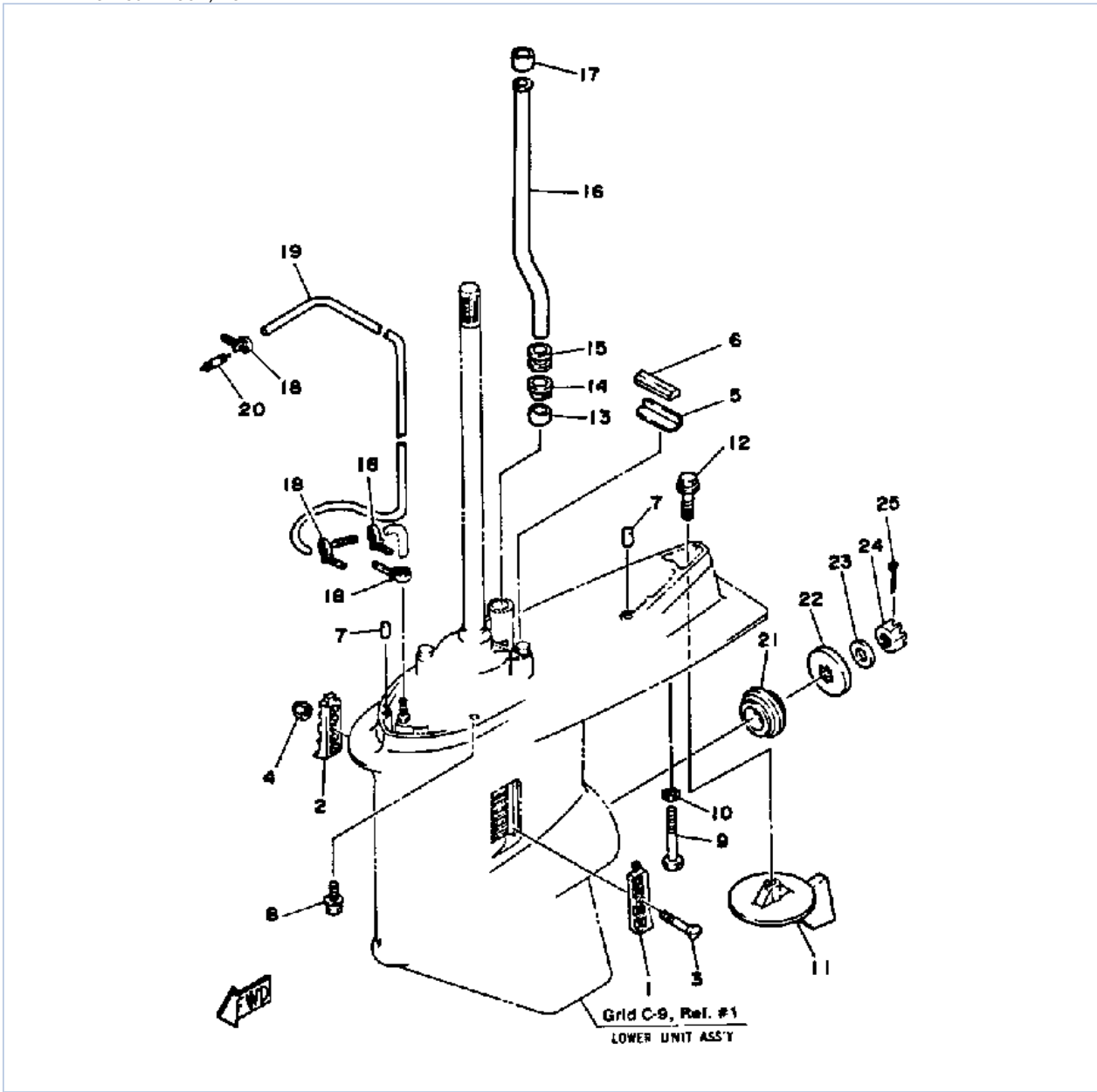

©2013 Yamaha Motor Corporation, U.S.A. All rights reserved.



Part List

PROV150LH 1987 / LOWER DRIVE 2

REF - NO	PART NUMBER	PART NAME	QUANTITY	REMARKS
1	6J9-45214-00-00	COVER, WATER INLET 1	1	
2	6J9-45215-00-00	COVER, WATER INLET 2	1	
3	90142-05M04-00	SCREW	1	
4	90185-05002-00	NUT, NYLON	1	
5	663-45376-00-94	GUIDE, SEAL DAMPER	1	SEE NOTE
6	688-45375-00-00	DAMPER, SEAL	1	SEE NOTE
7	93608-12M05-00	PIN, DOWEL	2	
8	90101-10M70-00	BOLT	6	
9	97395-10070-00	BOLT	1	
10	92990-10100-00	WASHER, SPRING	1	
11	6J9-45371-01-00	TAB-TRIM	1	
12	90105-10M00-00	BOLT, FLANGE	1	
13	6E5-44365-00-00	DAMPER, WATER SEAL 1	1	SEE NOTE
14	6E5-44312-00-00	COVER, WATER PUMP HOUSING	1	SEE NOTE
15	6E5-44366-00-00	DAMPER, WATER SEAL 2	1	
16	6E5-44361-00-00	TUBE, WATER 1	1	
17	6E5-44365-00-00	DAMPER, WATER SEAL 1	1	
18	90465-11M10-00	CLAMP	4	
19	90445-07MF0-00	HOSE (L1030)	1	
20	6E5-83558-00-00	END, NIPPLE	1	
21	6E5-45987-00-00	SPACER 1	1	
22	688-45997-01-00	SPACER 2	1	
23	92990-18200-00	WASHER	1	
24	90171-18M04-00	NUT, CASTLE	1	
25	91490-40030-00	PIN. COTTER	1	

Part Notes

PROV150LH 1987 / LOWER DRIVE 2

PART NUMBER		NOTE TEXT
6J9-45371-01-00		OEM: This part number is among the Top 100 Most Popular Marine Maintenance Parts as of August 2013.
90105-10M00-00		OEM: This part number is among the Top 100 Most Popular Marine Maintenance Parts as of August 2013.
91490-40030-00		OEM: This part number is among the Top 100 Most Popular Marine Maintenance Parts as of August 2013.

©2013 Yamaha Motor Corporation, U.S.A. All rights reserved.

PROV150LH 1987 / CDI MAGNETO

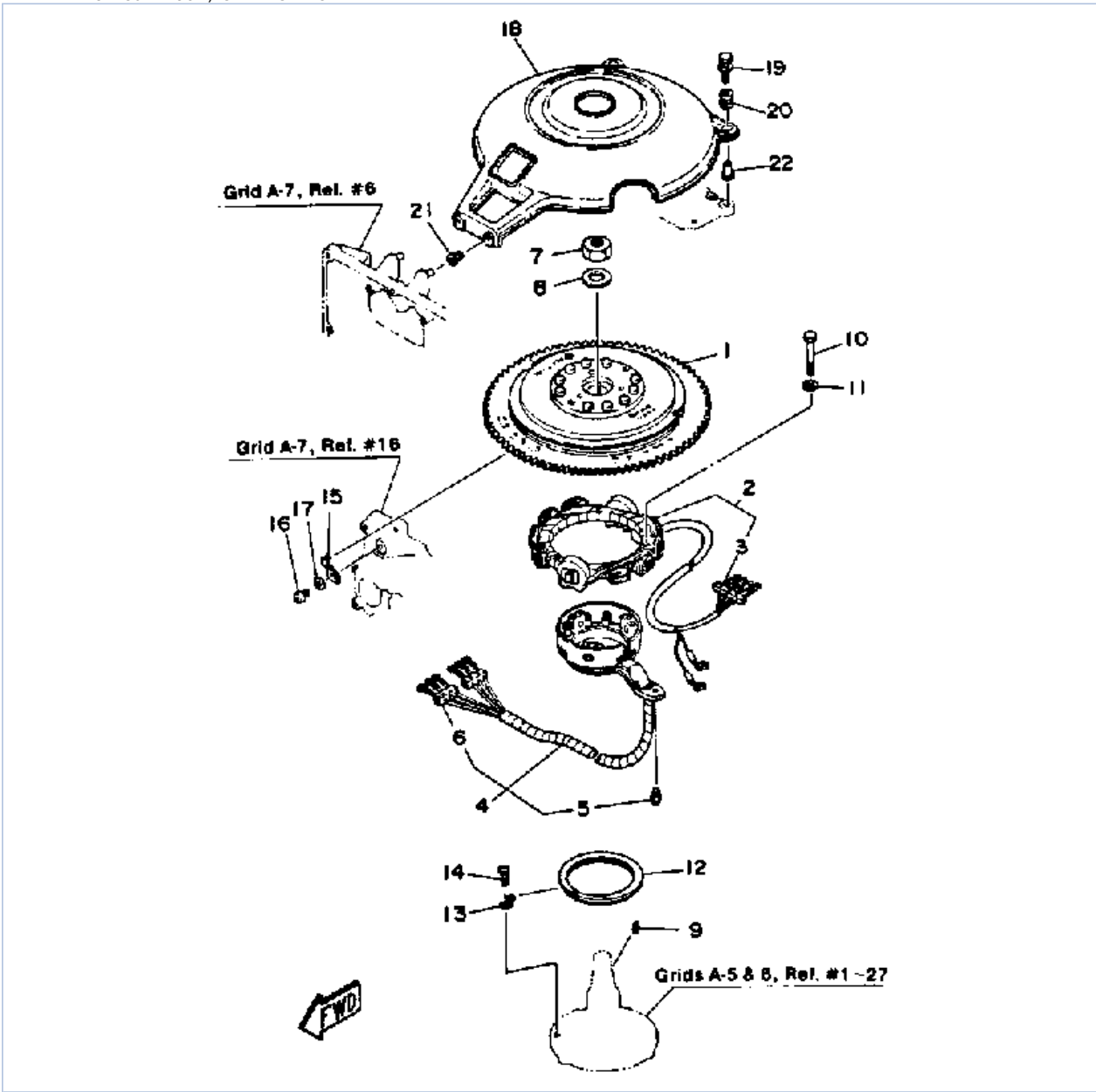

©2013 Yamaha Motor Corporation, U.S.A. All rights reserved.



Part List

PROV150LH 1987 / CDI MAGNETO

REF - NO	PART NUMBER	PART NAME	QUANTITY	REMARKS
1	6G5-85550-12-00	ROTOR ASSY	1	
2	6G5-85510-11-00	STATOR ASSY	1	
3	90480-06M16-00	.GROMMET	1	
4	6G5-85580-13-00	COIL, PULSER	1	
5	663-85518-00-00	.JOINT, BALL	1	
6	90480-06M16-00	.GROMMET	1	
7	90170-20137-00	NUT	1	
8	90201-21M18-00	WASHER, PLATE	1	
9	90280-05049-00	KEY, WOODRUFF	1	
10	97313-06055-00	BOLT, HEXAGON	3	
11	92990-06600-00	WASHER, PLATE	3	
12	688-41611-00-00	RETAINER, MAGNETO BASE	1	
13	688-41612-00-00	RETAINER, MAGNETO BASE	4	
14	98580-06018-00	SCREW, PAN HEAD	4	
15	6E5-81332-00-00	PLATE, TIMING	1	
16	98580-06010-00	SCREW, PAN HEAD	1	
17	92990-06600-00	WASHER, PLATE	1	
18	6E5-81337-00-00	COVER, FLYWHEEL	1	
19	90119-06M27-00	BOLT, W/WASHER	2	
20	663-82317-00-00	DAMPER, IGNITION COIL	2	
21	6G5-82317-00-00	DAMPER, IGNITION COIL	2	
22	624-42542-00-00	PIPE	2	

Part Notes

PROV150LH 1987 / CDI MAGNETO

PART NUMBER		NOTE TEXT
92990-06600-00		OEM: This part number is among the Top 100 Most Popular Marine Maintenance Parts as of August 2013.
92990-06600-00		OEM: This part number is among the Top 100 Most Popular Marine Maintenance Parts as of August 2013.

©2013 Yamaha Motor Corporation, U.S.A. All rights reserved.

PROV150LH 1987 / ELECTRIC MOTOR

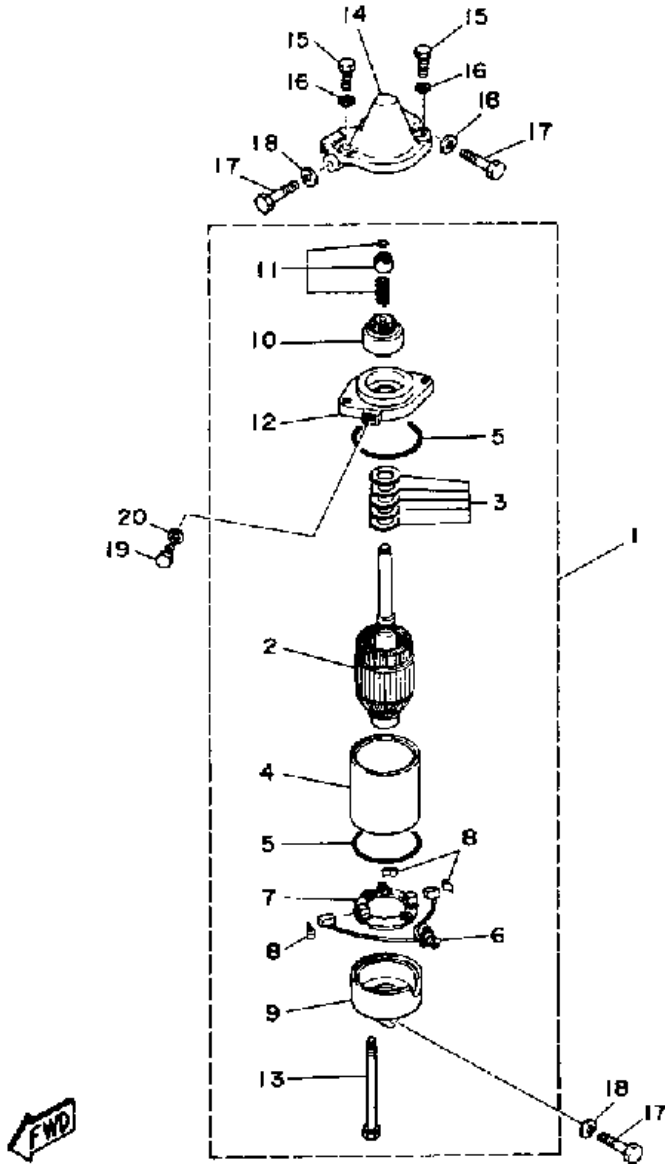

©2013 Yamaha Motor Corporation, U.S.A. All rights reserved.

Part List

PROV150LH 1987 / ELECTRIC MOTOR

REF - NO	PART NUMBER	PART NAME	QUANTITY	REMARKS
1	6E5-81800-12-00	STARTER MOTOR ASSY	1	
2	6E5-81850-A9-00	.ARMATURE ASSY (6E5-81850-10-00)	1	
3	6E5-81809-10-00	.WASHER KIT	1	
4	6E5-81810-10-00	.STATOR ASSY	2	
5	6E5-81847-10-00	.O-RING	2	
6	6E5-81801-10-00	.BRUSH SET	1	
7	6E5-81840-10-00	.BRUSH HOLDER ASSY	1	
8	6E5-81813-10-00	.SPRING, BRUSH	3	
9	6E5-81820-11-00	.REAR BRACKET ASSY	1	
10	6E5-81807-11-00	.GEAR ASSY, STARTING MOTOR	1	
11	6E5-81857-10-00	.RETAINER	1	
12	6E5-81830-10-00	.FRONT BRACKET ASSY	1	
13	6E5-81826-10-00	.BOLT	2	
14	6E5-81822-02-98	BRACKET, STARTING MOTOR	1	
15	97013-08025-00	BOLT	2	
16	92990-08600-00	.WASHER, PLATE	2	
17	97313-08045-00	BOLT, HEXAGON	3	
18	92990-08600-00	.WASHER, PLATE	3	
19	97395-08016-00	BOLT	1	
20	92990-08600-00	.WASHER, PLATE	1	

PROV150LH 1987 / ELECTRIC PARTS 1

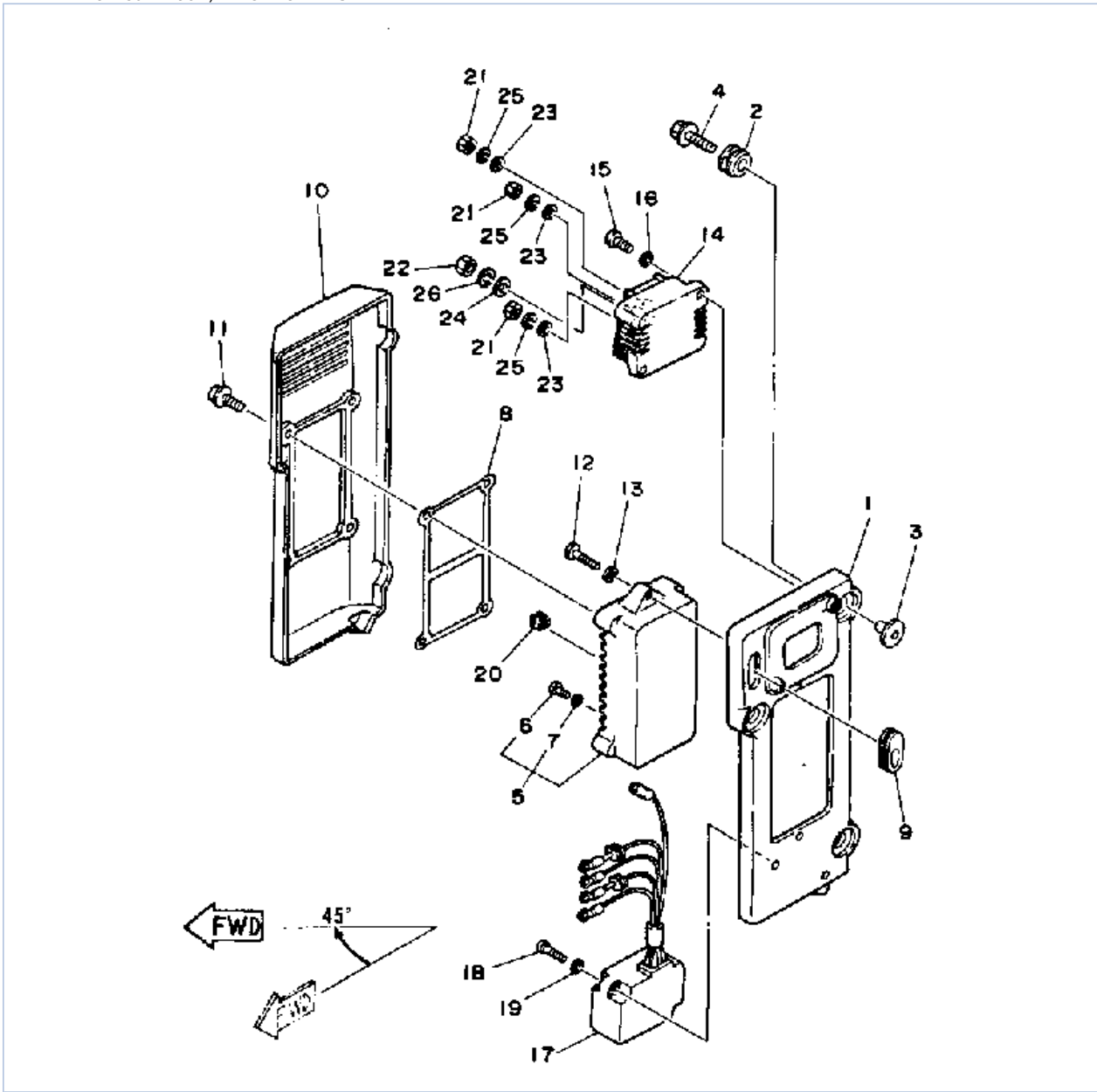

©2013 Yamaha Motor Corporation, U.S.A. All rights reserved.





Part List

PROV150LH 1987 / ELECTRIC PARTS 1

REF - NO	PART NUMBER	PART NAME	QUANTITY	REMARKS
1	6G5-85542-00-94	BRACKET	1	
2	90480-09M12-00	GROMMET	3	
3	90387-06M03-00	COLLAR	3	
4	90119-06M28-00	BOLT, WITH WASHER	3	
5	6G5-85540-12-00	CDI UNIT ASSY	1	
6	98580-04008-00	.SCREW, PAN HEAD	20	
7	92990-04200-00	.WASHER	20	
8	6G5-85547-00-00	DAMPER	1	
9	90480-12M32-00	GROMMET	1	
10	6G5-85537-00-00	COVER	1	
11	90159-06M03-00	SCREW, WITH WASHER	4	
12	98580-06030-00	.SCREW, PAN HEAD	2	
13	92990-06600-00	WASHER, PLATE	2	
14	6G5-81960-A0-00	RECTIFIER & REGULATOR ASSY	1	
15	97803-06020-00	SCREW, PAN HEAD (92580- 06030-00)	2	
16	92990-06600-00	WASHER, PLATE	2	
17	6G5-85590-12-00	CONTROL UNIT ASSY	1	
18	98580-06030-00	.SCREW, PAN HEAD	2	
19	92990-06600-00	WASHER, PLATE	2	
20	90480-06066-00	GROMMET	2	
21	95380-05600-00	NUT	3	
22	95380-06600-00	NUT, HEXAGON	1	
23	92990-05200-00	WASHER, PLAIN	3	
24	92990-06200-00	..WASHER, PLAIN	1	
25	92990-05100-00	.WASHER, SPRING	3	
26	92995-06100-00	WASHER, SPRING	1	

Part Notes

PROV150LH 1987 / ELECTRIC PARTS 1

PART NUMBER		NOTE TEXT
92990-06600-00		OEM: This part number is among the Top 100 Most Popular Marine Maintenance Parts as of August 2013.
92990-06600-00		OEM: This part number is among the Top 100 Most Popular Marine Maintenance Parts as of August 2013.
92990-06600-00		OEM: This part number is among the Top 100 Most Popular Marine Maintenance Parts as of August 2013.
92995-06100-00		OEM: This part number is among the Top 100 Most Popular Marine Maintenance Parts as of August 2013.

©2013 Yamaha Motor Corporation, U.S.A. All rights reserved.

PROV150LH 1987 / ELECTRIC PARTS 2

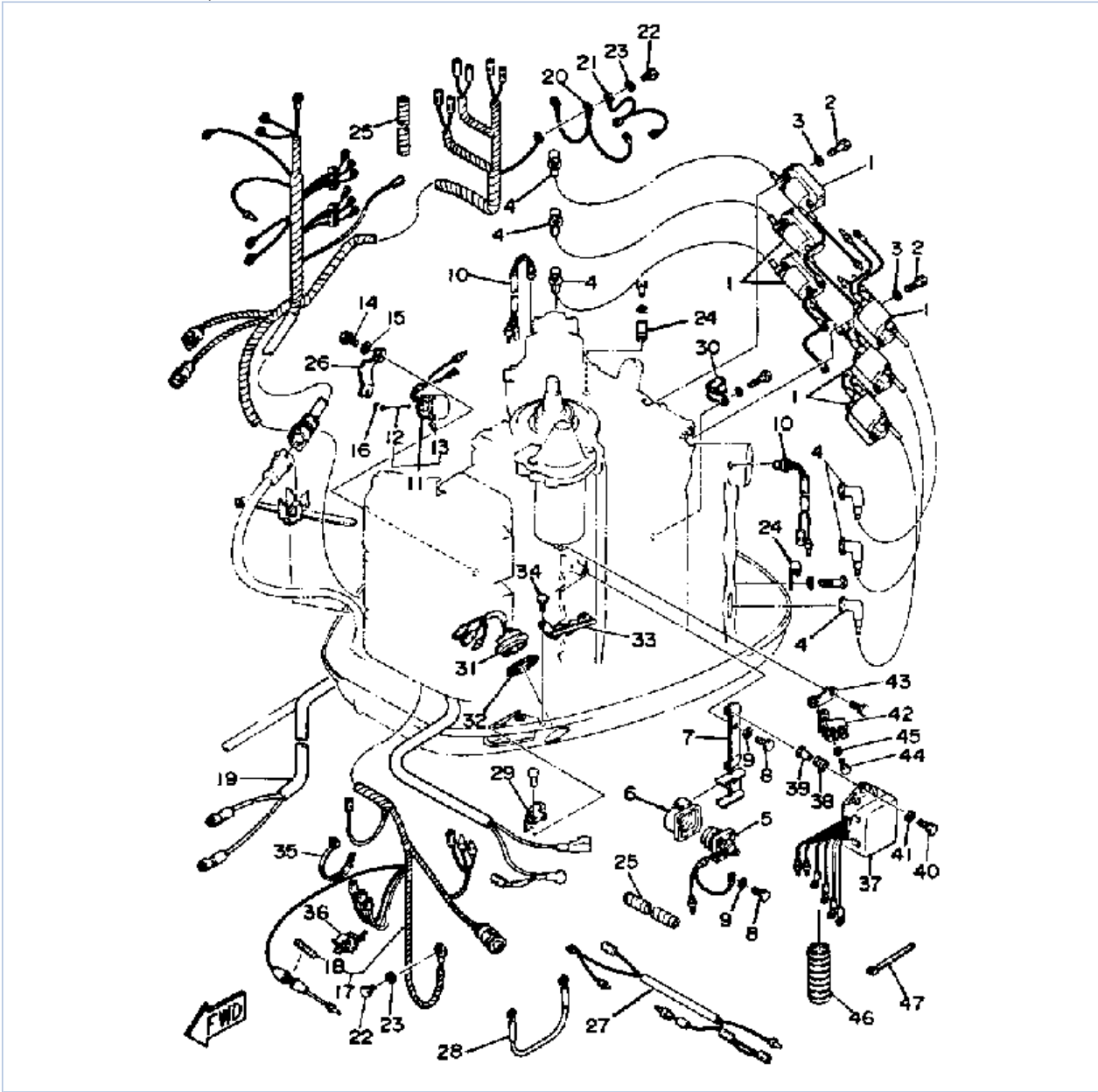

©2013 Yamaha Motor Corporation, U.S.A. All rights reserved.

Part List

PROV150LH 1987 / ELECTRIC PARTS 2

REF - NO	PART NUMBER	PART NAME	QUANTITY	REMARKS
1	6E5-85570-11-00	IGNITION COIL ASSEMBLY	6	
2	97313-06030-00	BOLT	12	
3	92990-06600-00	WASHER, PLATE	12	
4	663-82370-01-00	PLUG CAP ASSY	6	
5	6E5-81941-11-00	STARTER RELAY ASSY	1	
6	689-81952-10-00	HOLDER, RELAY	1	
7	6G5-81948-10-00	BRACKET	1	
8	97395-06016-00	BOLT	2	
9	92990-06600-00	WASHER, PLATE	2	
10	688-82560-10-00	THERMO SWITCH ASSY	2	
11	6G5-86110-01-00	SOLENOID	1	
12	6G5-86119-00-00	.WIRE, PULL	1	
13	91690-30010-00	.PIN, SPRING	1	
14	97313-06016-00	BOLT, HEXAGON	2	
15	92990-06600-00	WASHER, PLATE	2	
16	93210-03261-00	O-RING	1	
17	6G5-82590-12-00	WIRE HARNESS ASSY	1	
18	682-82151-00-00	.FUSE (12V-20A)	1	
19	6G5-82105-01-00	BATTERY CABLE	1	
20	6E5-82519-00-00	WIRE, EARTH LEAD	1	
21	6E5-82531-00-00	WIRE, LEAD	1	
22	97395-06012-00	BOLT	4	
23	92990-06600-00	WASHER, PLATE	4	
24	90465-08028-00	CLAMP	6	
25	90446-10M01-00	HOSE (L60)	4	
26	6G5-86115-00-00	HOLDER, SOLENOID	1	
27	6G5-82553-00-00	EXTENSION, WIRE LEAD	1	
28	6E5-82117-00-00	WIRE, LEAD	1	
29	90465-12M25-00	CLAMP	1	
30	90465-08M08-00	CLAMP	2	
31	6E5-82563-00-00	TRIM & TILT SWITCH ASSY	1	
32	6E5-82587-00-00	GASKET	1	
33	6E5-83614-01-00	BRACKET	1	
34	97313-06016-00	BOLT, HEXAGON	2	
35	90465-13M36-00	CLAMP	1	
36	6G5-82152-00-00	HOLDER, FUSE	1	
37	6G5-81950-01-00	RELAY ASSY	1	
38	6A0-82317-00-00	DAMPER, IGNITION COIL	2	
39	624-42542-00-00	PIPE	2	
40	97313-06025-00	BOLT	2	
41	90201-06M62-00	WASHER, PLATE	2	
42	6H5-81920-00-00	TERMINAL ASSY	1	
43	6G5-81929-00-00	BRACKET, TERMINAL	1	
44	97395-06012-00	BOLT	1	
45	92990-06600-00	WASHER, PLATE	1	
46	6G5-83557-00-00	TUBE	1	
47	90465-11M10-00	CLAMP	2	

Part Notes

PROV150LH 1987 / ELECTRIC PARTS 2

PART NUMBER	NOTE TEXT
92990-06600-00 	OEM: This part number is among the Top 100 Most Popular Marine Maintenance Parts as of August 2013.

92990-06600-00		OEM: This part number is among the Top 100 Most Popular Marine Maintenance Parts as of August 2013.
92990-06600-00		OEM: This part number is among the Top 100 Most Popular Marine Maintenance Parts as of August 2013.
92990-06600-00		OEM: This part number is among the Top 100 Most Popular Marine Maintenance Parts as of August 2013.
92990-06600-00		OEM: This part number is among the Top 100 Most Popular Marine Maintenance Parts as of August 2013.

©2013 Yamaha Motor Corporation, U.S.A. All rights reserved.

Part List

PROV150LH 1987 / OIL PUMP

REF - NO	PART NUMBER	PART NAME	QUANTITY	REMARKS
1	6G5-W1320-00-00	OIL INJECTION PUMP ASSY (6G5-13200-01-00)	1	
2	6E5-13471-01-00	.PLUG, DRAIN	1	
3	6E5-13475-00-00	.GASKET	1	
4	6E5-14562-00-00	.O-RING	1	
5	90109-06M23-00	BOLT	2	
6	(90445-12M65-00)	HOSE	1	
7	90465-11M10-00	CLAMP	2	
8	90445-07M73-00	HOSE	2	
9	90445-07M85-00	HOSE (L330)	1	
10	90445-07M83-00	HOSE (L150)	3	
11	90468-07M02-00	CLIP	24	
12	90464-07M05-00	CLAMP	2	
13	6E5-11536-00-00	GEAR, DRIVEN	1	
14	6E5-11537-02-00	GEAR, DRIVEN	1	
15	6E5-13117-01-00	COLLAR, DISTANCE	1	
16	90201-08M93-00	WASHER, PLATE	1	
17	6E5-41241-00-00	ROD, LINK	1	
18	95380-05600-00	NUT	1	
19	6R5-41237-00-00	JOINT, LINK	1	
20	6E5-14276-01-00	LEVER	1	
21	91690-30016-00	PIN, SPRING	1	
22	6H1-41237-00-00	JOINT, LINK	1	
23	90445-07M87-00	HOSE (L110)	3	
24	90445-07M96-00	HOSE (L310)	3	
25	6E5-13132-00-00	JOINT	6	
26	90202-05088-00	WASHER, PLATE	1	
27	90468-05M03-00	CLIP	1	

Part Notes

PROV150LH 1987 / OIL PUMP

PART NUMBER	NOTE TEXT
6H1-41237-00-00 	OEM: This part number is among the Top 100 Most Popular Marine Maintenance Parts as of August 2013.

©2013 Yamaha Motor Corporation, U.S.A. All rights reserved.

PROV150LH 1987 / OIL PUMP CONVERSION KIT

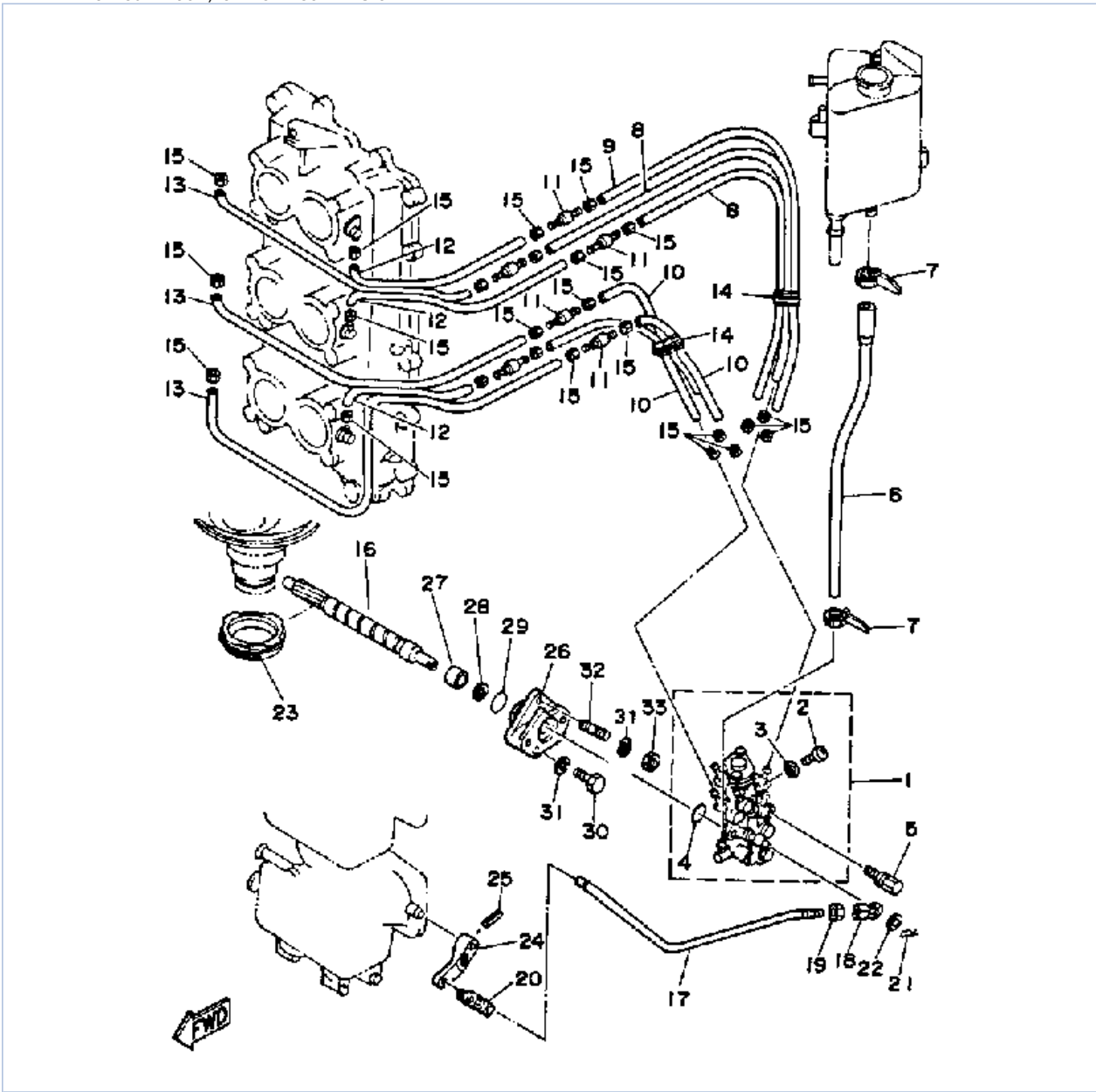

©2013 Yamaha Motor Corporation, U.S.A. All rights reserved.



Part List

PROV150LH 1987 / OIL PUMP CONVERSION KIT

REF - NO	PART NUMBER	PART NAME	QUANTITY	REMARKS
1	6R3-13200-09-00	OIL INJECTION PUMP ASSY	1	UR 150/ 175 MODEL
1	6R4-13200-09-00	OIL INJECTION PUMP ASSY	1	UR 200 MODEL
2	716-24444-00-00	.PLUG, DRAIN	1	
3	1YU-13187-00-00	.GASKET, BREATHER BOLT	1	
4	93210-19MA7-00	.O-RING	1	
5	90109-06M40-00	BOLT	2	
6	6R3-13416-00-00	PIPE, OIL 1	1	
7	90465-11M10-00	CLAMP	2	
8	90445-07M73-00	HOSE	2	
9	90445-07M85-00	HOSE (L330)	1	
10	90445-07M83-00	HOSE (L150)	3	
11	6R3-13183-00-00	VALVE, CHECK	6	
12	90445-07M87-00	HOSE (L110)	3	
13	90450-7M960-0	UNAVAILABLE IN PRICE BOOK	3	
14	90464-07M05-00	CLAMP	2	
15	90468-07M02-00	CLIP	24	
16	6R3-11537-09-00	GEAR, DRIVEN	1	
17	6R3-41241-00-00	ROD, LINK	1	
18	6H1-41237-00-00	JOINT, LINK	1	
19	95380-05600-00	NUT	1	
20	6R5-41237-00-00	JOINT, LINK	1	
21	90468-05M03-00	CLIP	1	
22	90202-05088-00	WASHER, PLATE	1	
23	6E5-11536-00-00	GEAR, DRIVEN	1	
24	6E5-14276-01-00	LEVER	1	
25	91690-30016-00	PIN, SPRING	1	
26	6R3-13117-09-00	COLLAR, DISTANCE	1	
27	90384-14M09-00	.BUSH, BIMETAL FORMED	1	
28	90202-08M44-00	WASHER, PLATE	1	
29	93210-18322-00	O-RING	1	
30	97313-06018-00	BOLT	1	
31	92995-06100-00	WASHER, SPRING	2	
32	90116-06M22-00	BOLT, STUD	1	
33	95380-06600-00	NUT, HEXAGON	1	

Part Notes

PROV150LH 1987 / OIL PUMP CONVERSION KIT

PART NUMBER		NOTE TEXT
6H1-41237-00-00		OEM: This part number is among the Top 100 Most Popular Marine Maintenance Parts as of August 2013.
92995-06100-00		OEM: This part number is among the Top 100 Most Popular Marine Maintenance Parts as of August 2013.

©2013 Yamaha Motor Corporation, U.S.A. All rights reserved.

PROV150LH 1987 / OIL TANK

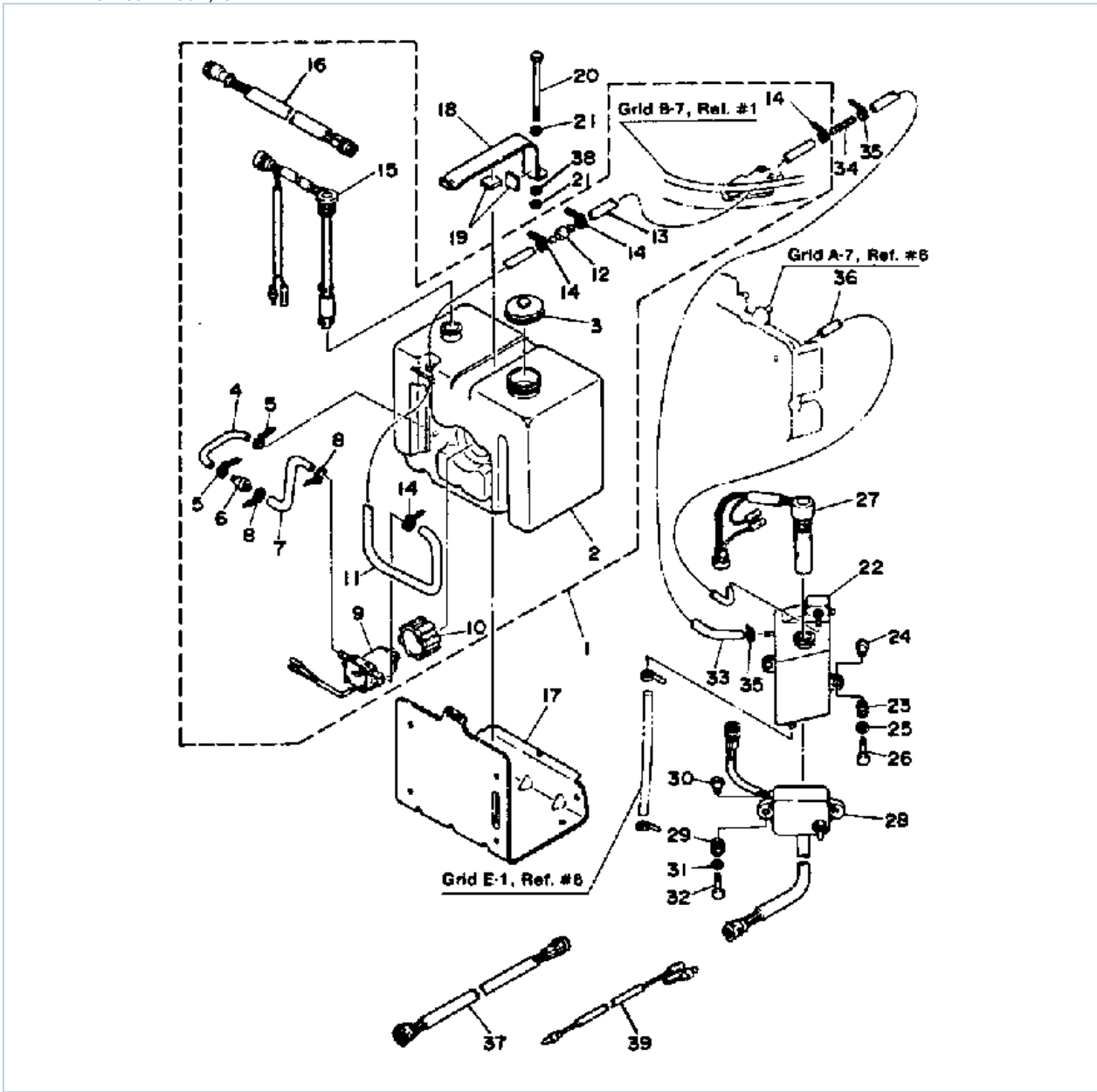

©2013 Yamaha Motor Corporation, U.S.A. All rights reserved.



Part List

PROV150LH 1987 / OIL TANK

REF - NO	PART NUMBER	PART NAME	QUANTITY	REMARKS
1	6E5-21708-05-00	OIL TANK SUB-ASSY	1	
2	6E5-21733-02-00	.SUB TANK, OIL (105L)	1	
3	6E5-21770-03-00	.OIL TANK CAP ASSY	1	
4	6E5-24322-00-00	.PIPE 11	1	
5	90465-11M10-00	.CLAMP	2	
6	646-24251-02-00	.STRAINER 1	1	
7	6E5-24319-01-00	.PIPE, OIL	1	
8	90465-11M10-00	.CLAMP	2	
9	6E5-81900-01-00	.OIL FEED PUMP ASSY	1	
10	6E5-81922-00-00	.GROMMET	1	
11	6E5-24321-01-00	.PIPE 10	1	
12	6E5-24379-00-00	.PIPE, JOINT 4	1	
13	90445-11M81-00	.HOSE (L3000)	1	
14	90465-11M10-00	.CLAMP	4	
15	6E5-85720-02-00	.OIL LEVEL GAUGE ASSY	1	
16	6E5-85721-10-00	.WIRE LEAD (6E5-85721-01-00)	1	
17	6E5-21734-01-33	HOLDER, OIL SUB TANK	1	
18	6E5-21798-01-33	BRACKET, DAMPER	1	
19	6E5-21746-00-00	DAMPER	2	
20	97380-06100-00	BOLT, HEXAGON (91201-06100)	1	
21	92990-06600-00	WASHER, PLATE	2	
22	6E5-21750-02-00	OIL TANK ASSEMBLY	1	
23	6A0-82317-00-00	DAMPER, IGNITION COIL	3	
24	624-42542-00-00	PIPE	3	
25	90201-06M62-00	WASHER, PLATE	3	
26	97313-06030-00	BOLT	3	
27	6E5-85730-12-00	OIL LEVEL SENSOR (6E5-85730-11)	1	
28	6E5-85740-02-00	CONTROL UNIT ASSY	1	
29	6A0-82317-00-00	DAMPER, IGNITION COIL	2	
30	624-42542-00-00	PIPE	2	
31	90201-06M62-00	WASHER, PLATE	2	
32	97313-06030-00	BOLT	2	
33	6E5-24323-00-00	PIPE 12	1	
34	6E5-24461-00-00	PIPE, JOINT	1	
35	90465-11M10-00	CLAMP	2	
36	90445-05M61-00	HOSE	1	
37	6E5-82551-03-00	UNAVAILABLE IN PRICE BOOK	1	
38	95380-06600-00	NUT, HEXAGON	1	
39	6G5-81315-00-00	LEAD WIRE ASSY	1	

Part Notes

PROV150LH 1987 / OIL TANK

PART NUMBER		NOTE TEXT
646-24251-02-00		OEM: This part number is among the Top 100 Most Popular Marine Maintenance Parts as of August 2013.
92990-06600-00		OEM: This part number is among the Top 100 Most Popular Marine Maintenance Parts as of August 2013.

©2013 Yamaha Motor Corporation, U.S.A. All rights reserved.

PROV150LH 1987 / STEERING GUIDE ATTACHMENT

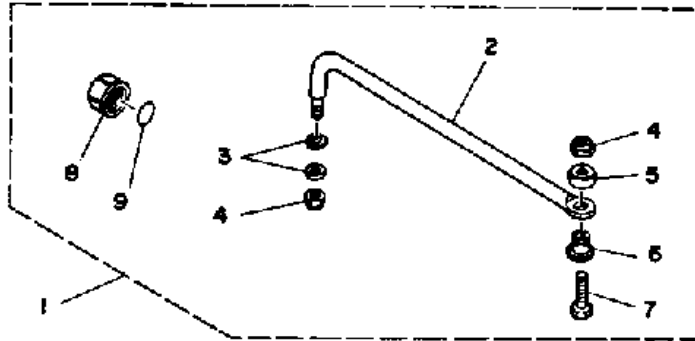

©2013 Yamaha Motor Corporation, U.S.A. All rights reserved.

Part List

PROV150LH 1987 / STEERING GUIDE ATTACHMENT

REF - NO	PART NUMBER	PART NAME	QUANTITY	REMARKS
1	6E5-61350-01-00	STEERING GUIDE ATTACHMENT KIT	1	
2	6E5-61351-00-00	.ROD, STEERING LINK	1	
3	90201-10M20-00	.WASHER, PLATE	2	
4	90185-09M01-00	.NUT, SELF-LOCKING	2	
5	90560-12M01-00	.SPACER	1	
6	90387-10M61-00	.COLLAR	1	
7	6E5-61355-00-00	.BOLT	1	
8	6E5-43145-00-00	.CAP, CLAMP BRACKET	1	
9	93210-16716-00	.O-RING	1	

PROV150LH 1987 / REPAIR KIT 1

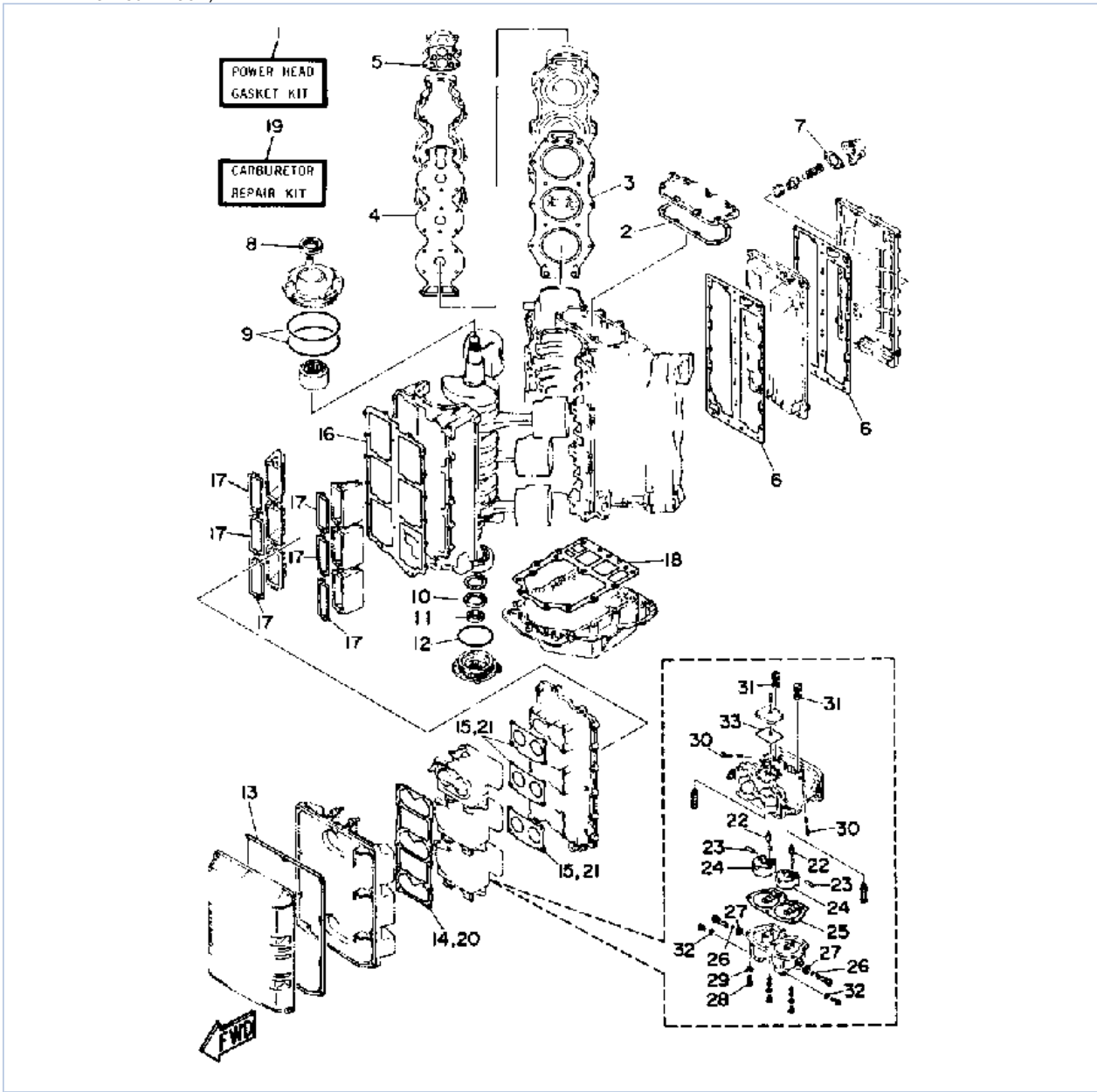

©2013 Yamaha Motor Corporation, U.S.A. All rights reserved.

Part List

PROV150LH 1987 / REPAIR KIT 1

REF - NO	PART NUMBER	PART NAME	QUANTITY	REMARKS
1	6G5-W0001-03-00	POWER HEAD GASKET KIT	1	
2	6E5-11381-00-00	.GASKET 1	1	
3	6G5-11181-A1-00	.GASKET, CYLINDER HEAD 1	2	
4	6G5-11193-01-00	.GASKET, HEAD COVER 1	2	
5	688-12414-A1-00	.GASKET, COVER	2	
6	6G5-41112-A1-00	.GASKET, EXHAUST INNER COVER	2	
7	6G5-11382-A1-00	.GASKET 2	1	
8	93102-40M38-00	.OIL SEAL	1	
9	93211-04384-00	.O-RING	2	
10	93102-35M13-00	.OIL SEAL	1	
11	93101-22M15-00	.OIL SEAL	1	
12	93210-74M35-00	.O-RING	1	
13	6G5-14416-00-00	.GASKET, AIR CLEANER	1	
14	6G5-14483-01-00	.GASKET	1	
15	6E5-14198-A1-00	.GASKET	3	
16	6G5-13645-A1-00	.GASKET, MANIFOLD 1	1	
17	6E5-13621-00-00	.GASKET, VALVE SEAT	6	
18	6G5-45113-A0-00	.GASKET, UPPER CASING	1	
19	6E5-W0093-06-00	CARBURETOR REPAIR KIT	1	
20	6G5-14483-01-00	.GASKET	1	
21	6E5-14198-A1-00	.GASKET	1	
22	6E5-14546-00-00	.VALVE, NEEDLE	3	
23	6E5-14386-02-00	.PIN, FLOAT	3	
24	6E5-14385-02-00	.FLOAT	3	
25	6E5-14384-03-00	.GASKET, FLOAT CHAMBER	3	
26	6E5-14997-00-00	.O-RING	6	
27	6E5-14398-01-00	.GASKET	6	
28	98580-05016-00	.SCREW, PAN HEAD	3	
29	92990-05100-00	.WASHER, SPRING	3	
30	6E5-14323-03-00	.SCREW, AIR ADJUSTING	6	
31	6E5-14979-00-00	.GASKET	6	
32	6J8-14995-00-00	.GASKET	6	
33	6E5-14959-01-00	.GASKET	3	

Part Notes

PROV150LH 1987 / REPAIR KIT 1

PART NUMBER	NOTE TEXT
688-12414-A1-00 	OEM: This part number is among the Top 100 Most Popular Marine Maintenance Parts as of August 2013.

©2013 Yamaha Motor Corporation, U.S.A. All rights reserved.

PROV150LH 1987 / REPAIR KIT 2

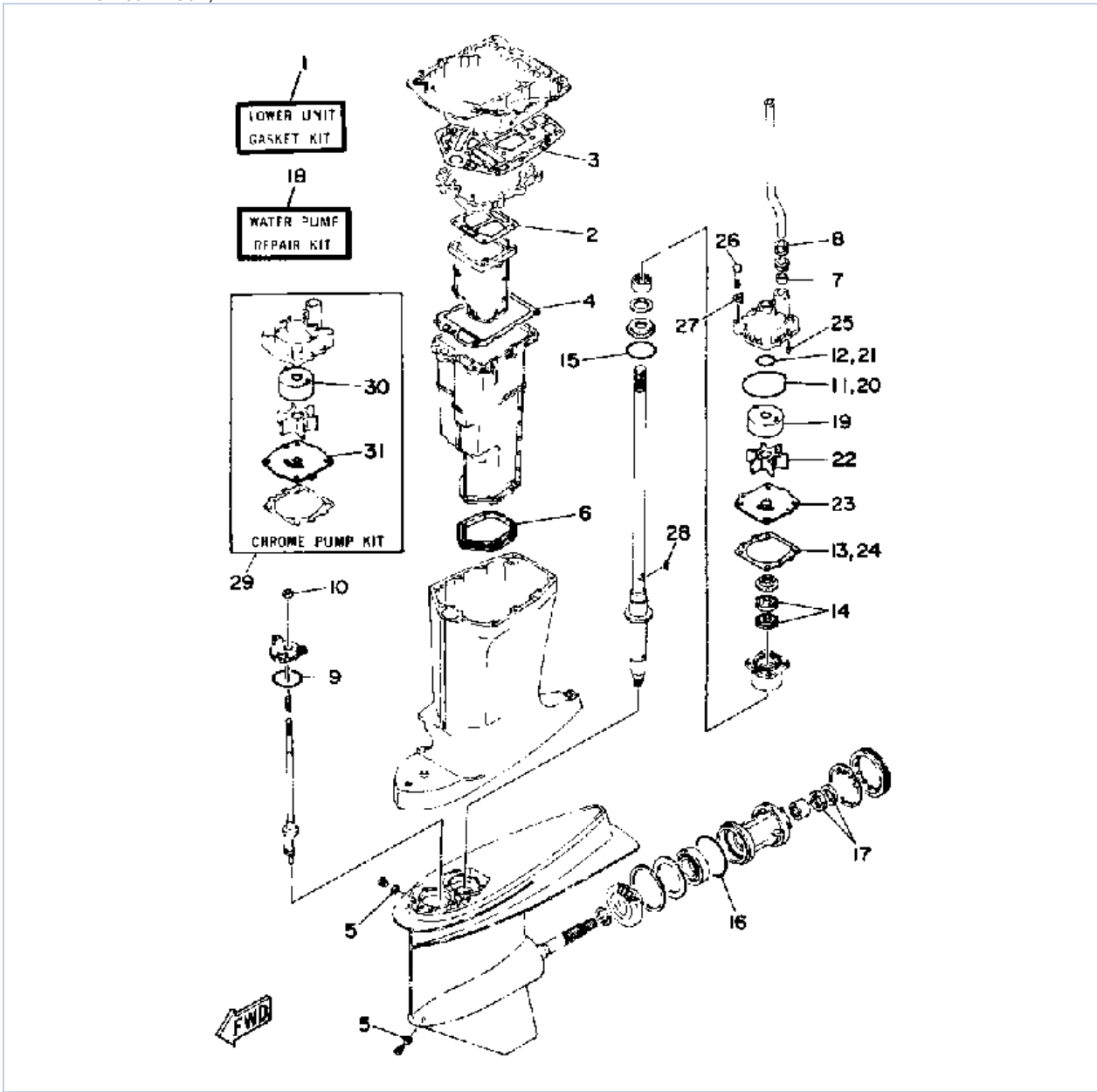

©2013 Yamaha Motor Corporation, U.S.A. All rights reserved.







Part List

PROV150LH 1987 / REPAIR KIT 2

REF - NO	PART NUMBER	PART NAME	QUANTITY	REMARKS
1	6G5-W0001-21-00	LOWER UNIT GASKET KIT	1	
2	6G5-41134-00-00	.GASKET, EXHAUST MANIFOLD	1	
3	6G5-45114-00-00	.GASKET, UPPER CASING	1	
4	6E5-41135-00-00	.GASKET, EXHAUST MANIFOLD	1	
5	90430-08020-00	.GASKET	2	
6	6E5-45123-00-00	.GASKET, MUFFLER	1	
7	6E5-44365-00-00	.DAMPER, WATER SEAL 1	1	
8	6E5-44366-00-00	.DAMPER, WATER SEAL 2	1	
9	93210-58677-00	.O-RING	1	
10	93106-09014-00	.OIL SEAL	1	
11	93210-86M38-00	.O-RING	1	
12	93210-37M67-00	.O-RING	1	
13	6E5-44315-00-00	.GASKET, WATER PUMP	1	
14	93101-28M16-00	.OIL SEAL	2	
15	93210-54534-00	.O-RING	1	
16	93210-97M55-00	.O-RING	1	
17	93101-30M17-00	.OIL SEAL	2	
18	6G5-W0078-01-00	WATER PUMP REPAIR KIT	1	
19	6E5-44322-00-00	.INSERT, CARTRIDGE	1	
20	93210-86M38-00	.O-RING	1	
21	93210-37M67-00	.O-RING	1	
22	6E5-44352-00-00	.IMPELLER	1	
23	6G5-44323-00-00	.OUTER PLATE, CARTRIDGE	1	
24	6E5-44315-00-00	.GASKET, WATER PUMP	1	
25	93606-12019-00	.PIN, DOWEL	1	
26	97395-08045-00	.BOLT	4	
27	90209-08M02-00	.WASHER	4	
28	90280-04M05-00	.KEY, WOODRUFF	1	
29	6G5-W0078-0A-00	CHROME PUMP KIT	1	
30	6E5-44322-41-00	.INSERT, CARTRIDGE	1	
31	6G5-44323-40-00	.OUTER PLATE, CARTRIDGE	1	

Part Notes

PROV150LH 1987 / REPAIR KIT 2

PART NUMBER		NOTE TEXT
90430-08020-00		OEM: This part number is among the Top 100 Most Popular Marine Maintenance Parts as of August 2013.
93106-09014-00		OEM: This part number is among the Top 100 Most Popular Marine Maintenance Parts as of August 2013.
93210-86M38-00		OEM: This part number is among the Top 100 Most Popular Marine Maintenance Parts as of August 2013.
93101-28M16-00		OEM: This part number is among the Top 100 Most Popular Marine Maintenance Parts as of August 2013.
93210-54534-00		OEM: This part number is among the Top 100 Most Popular Marine Maintenance Parts as of August 2013.
93101-30M17-00		OEM: This part number is among the Top 100 Most Popular Marine Maintenance Parts as of August 2013.
93210-86M38-00		OEM: This part number is among the Top 100 Most Popular Marine Maintenance Parts as of August 2013.

©2013 Yamaha Motor Corporation, U.S.A. All rights reserved.

©2013 Yamaha Motor Corporation, U.S.A. All rights reserved.