

115TXRQ 1992 / CYLINDER CRANKCASE

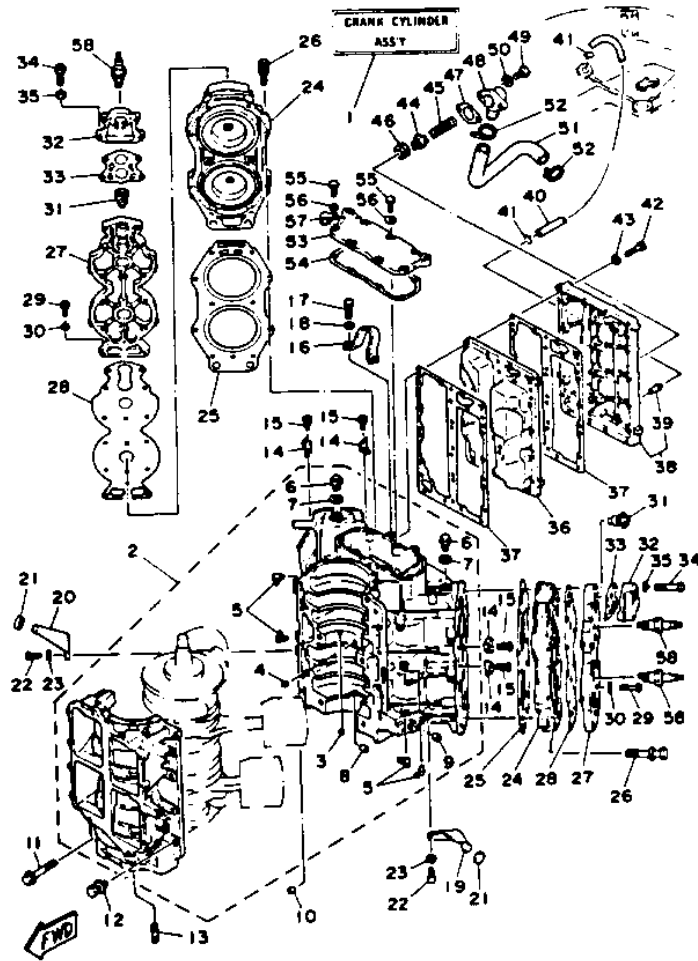

©2014 Yamaha Motor Corporation, U.S.A. All rights reserved.

## Part List









115TXRQ 1992 / CYLINDER CRANKCASE

REF - NO	PART NUMBER	PART NAME	QUANTITY	REMARKS
1	6N7-W0090-10-EK	CRANK-CYLINDER ASSEMBLY.	1	UR 130 MODEL
1	6N6-W0090-10-EK	CRANK CYLINDER. ASS"Y (REF. #2~56 & GRIDS A8-9, REF. #1)	1	UR 115 MODEL
2	6N6-15100-00-94	CRANKCASE ASSEMBLY	1	UR 115 MODEL
2	6N7-15100-00-94	CRANKCASE ASSEMBLY	1	UR 130 MODEL
3	624-11379-00-00	.VALVE, CHECK	1	
4	663-11518-01-00	.LOCK BEARING	1	
5	6E5-11372-00-00	.NIPPLE, HOSE	4	
6	90340-14M00-00	.PLUG, STRAIGHT SCREW	2	
7	90430-14115-00	.GASKET	2	
8	90384-06M07-00	.BUSH, BIMETAL FORMED	1	
9	90384-14M09-00	.BUSH, BIMETAL FORMED	1	
10	93608-12063-00	PIN, DOWEL	2	
11	90105-10M20-00	BOLT, FLANGE	6	
12	90119-08M23-00	BOLT, W/WASHER	8	
13	90116-08M45-00	BOLT, STUD	2	
14	6E5-11325-00-00	ANODE	4	
15	98680-04016-00	SCREW OVAL HEAD	4	
16	6E5-11119-00-00	HANGER, ENGINE	1	
17	97313-08020-00	BOLT, HEXAGON	2	
18	92990-08100-00	WASHER, SPRING	2	
19	6E5-42761-00-94	STOPPER	1	
20	6E5-42762-00-94	STOPPER	1	
21	663-44533-00-00	DAMPER, UPPER MOUNT RUBBER	2	
22	97313-06020-00	BOLT, HEXAGON	4	
23	92990-06600-00	WASHER, PLATE	4	
24	6L1-11111-00-94	HEAD, CYLINDER 1	2	UR 130 MODEL
24	6E5-11111-10-94	HEAD, CYLINDER 1	2	UR 115 MODEL
25	6E5-11181-A0-00	GASKET, CYLINDER HEAD 1	2	
26	90119-08M21-00	BOLT, WITH WASHER	20	
27	6E5-11191-01-9M	COVER, CYLINDER HEAD 1	2	
28	6E5-11193-A0-00	.GASKET, HEAD COVER 1	2	
29	97313-06030-00	BOLT	24	
30	92990-06600-00	WASHER, PLATE	24	
31	6E5-12411-20-00	THERMOSTAT	2	
32	6G5-12413-00-9M	COVER, THERMOSTAT	2	
33	688-12414-A1-00	.GASKET, COVER	2	
34	97313-06040-00	BOLT, HEXAGON	8	
35	92990-06600-00	WASHER, PLATE	8	
36	6E5-41111-00-9M	INNER COVER, EXHAUST	1	UR 115 MODEL
36	6L1-41111-00-9M	INNER COVER, EXHAUST	1	UR 130 MODEL
37	6E5-41112-A0-00	GASKET, EXHAUST INNER COVER	2	
38	6N7-41113-00-9M	OUTER COVER, EXHAUST	1	
39	652-24461-00-00	.PIPE, JOINT 4	1	
40	6E5-24312-00-00	PIPE 2	1	
41	90467-08004-00	CLIP	2	
42	97013-06035-00	BOLT	23	
43	92990-06600-00	WASHER, PLATE	23	
44	6G5-12416-00-00	VALVE, PRESSURE CONTROL	1	
45	90501-16M11-00	SPRING, COMPRESSION	1	
46	90480-20M05-00	GROMMET	1	

47	6G5-11382-A1-00	.GASKET 2	1	
48	6G5-11372-00-5B	NIPPLE, HOSE (6G5-11372-00-9M)	1	
49	97313-06020-00	BOLT, HEXAGON	2	
50	92990-06600-00	WASHER, PLATE	2	
51	6E5-12576-00-00	HOSE 1	1	
52	90465-13M36-00	CLAMP	2	
53	6K7-11371-01-9M	COVER	1	
54	6E5-11381-A1-00	GASKET 1	1	
55	97313-06020-00	BOLT, HEXAGON	7	
56	92990-06600-00	WASHER, PLATE	7	
57	90465-08028-00	CLAMP	1	
58	NGK-B9HS1-00-00	NGK B9HS-10 10PK	4	UR 130 MODEL
58	NGK-B8HS1-00-00	PLUG, SPARK (NGK B8HS-10)	4	UR 115 MODEL

## Part Notes

115TXRQ 1992 / CYLINDER CRANKCASE

PART NUMBER		NOTE TEXT
92990-06600-00		OEM: This part number is among the Top 100 Most Popular Marine Maintenance Parts as of March 2014.
92990-06600-00		OEM: This part number is among the Top 100 Most Popular Marine Maintenance Parts as of March 2014.
688-12414-A1-00		OEM: This part number is among the Top 100 Most Popular Marine Maintenance Parts as of March 2014.
92990-06600-00		OEM: This part number is among the Top 100 Most Popular Marine Maintenance Parts as of March 2014.
92990-06600-00		OEM: This part number is among the Top 100 Most Popular Marine Maintenance Parts as of March 2014.
90480-20M05-00		OEM: This part number is among the Top 100 Most Popular Marine Maintenance Parts as of March 2014.
92990-06600-00		OEM: This part number is among the Top 100 Most Popular Marine Maintenance Parts as of March 2014.
92990-06600-00		OEM: This part number is among the Top 100 Most Popular Marine Maintenance Parts as of March 2014.

©2014 Yamaha Motor Corporation, U.S.A. All rights reserved.

115TXRQ 1992 / CRANKSHAFT PISTON

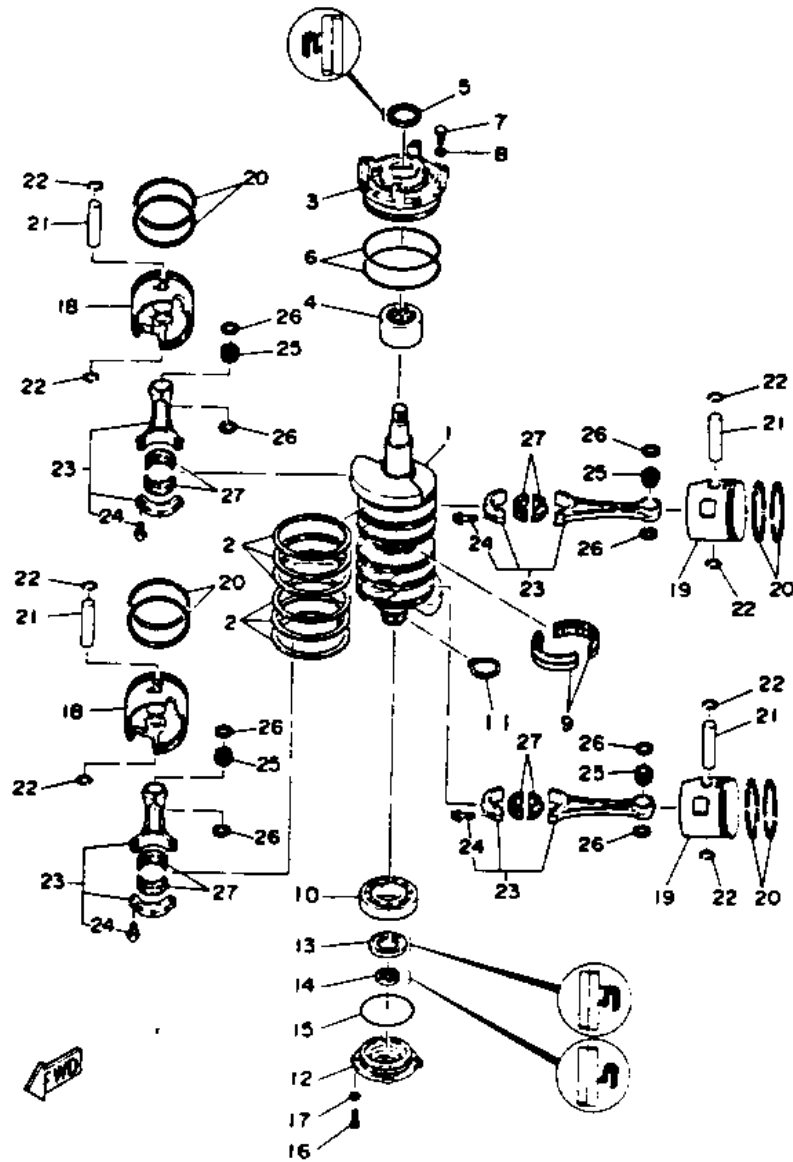

©2014 Yamaha Motor Corporation, U.S.A. All rights reserved.





## Part List

115TXRQ 1992 / CRANKSHAFT PISTON

REF - NO	PART NUMBER	PART NAME	QUANTITY	REMARKS
1	6N7-11411-00-00	CRANKSHAFT	1	
2	6E5-11447-00-00	SEAL, CRANK	6	
3	6R3-15163-00-94	HOUSING, BEARING 1	1	
4	93311-940U3-00	BEARING	1	
5	93102-40M38-00	OIL SEAL	1	
6	93211-04384-00	.O-RING	2	
7	97313-06020-00	BOLT, HEXAGON	3	
8	92990-06600-00	WASHER, PLATE	3	
9	93310-954V3-00	BEARING, CYLINDRICAL	1	
10	93306-208U0-00	BEARING	1	
11	93410-40M03-00	CIRCLIP	1	
12	6G5-15359-00-94	HOUSING, OIL SEAL	1	
13	93102-35M13-00	OIL SEAL	1	
14	93101-22M15-00	.OIL SEAL	1	
15	93210-74M35-00	.O-RING	1	
16	97395-06020-00	BOLT, HEXAGON	4	
17	92990-06600-00	WASHER, PLATE	4	
18	6R5-11631-01-93	PISTON (STD)	2	
18	6R5-11636-01-00	PISTON (0.50MM O/S)	2	AP
19	6R5-11646-01-00	PISTON (2ND O/S 0.50MM)	2	AP
19	6R5-11642-01-93	PISTON 2 (STD)	2	
20	6R5-11603-00-00	PISTON RING SET (STD)	4	
20	6R5-11605-00-00	PISTON RING SET (0.50MM O/S)	4	AP
21	6K7-11633-00-00	PIN, PISTON	4	
22	6E5-11634-00-00	CLIP, PISTON PIN	8	
23	6E5-11650-01-00	CONNECTING ROD ASSY	4	
24	90109-08M61-00	.BOLT	2	
25	93603-21111-00	PIN, DOWEL	120	
26	90201-21M75-00	WASHER, PLATE	8	
27	93310-836V2-00	BEARING	4	

## Part Notes

115TXRQ 1992 / CRANKSHAFT PISTON

PART NUMBER		NOTE TEXT
93211-04384-00		OEM: This part number is among the Top 100 Most Popular Marine Maintenance Parts as of March 2014.
92990-06600-00		OEM: This part number is among the Top 100 Most Popular Marine Maintenance Parts as of March 2014.
92990-06600-00		OEM: This part number is among the Top 100 Most Popular Marine Maintenance Parts as of March 2014.
93603-21111-00		OEM: This part number is among the Top 100 Most Popular Marine Maintenance Parts as of March 2014.

©2014 Yamaha Motor Corporation, U.S.A. All rights reserved.

115TXRQ 1992 / INTAKE

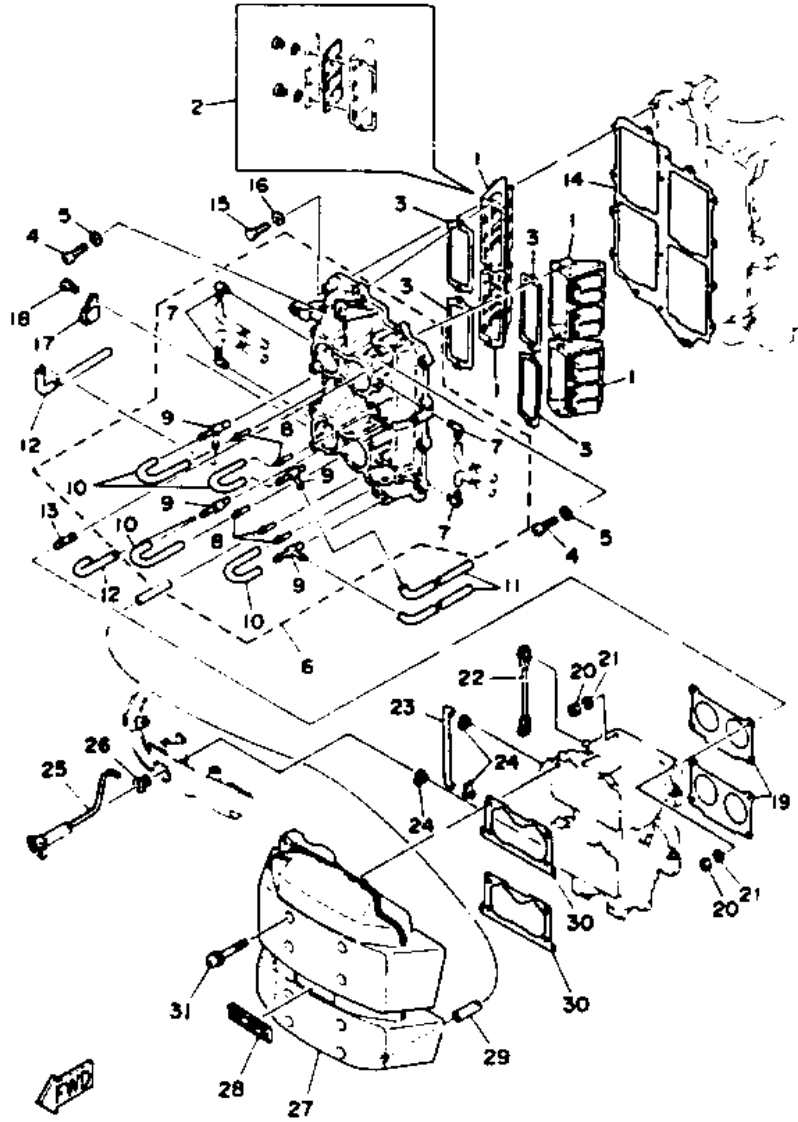

©2014 Yamaha Motor Corporation, U.S.A. All rights reserved.

## Part List

115TXRQ 1992 / INTAKE

REF - NO	PART NUMBER	PART NAME	QUANTITY	REMARKS
1	6E5-13610-00-00	REED VALVE ASSY	4	
2	6E5-W0004-00-00	.REED SET	1	
3	6E5-13621-A1-00	.GASKET, VALVE SEAT	4	
4	98503-05025-00	SCREW, PAN HEAD	8	
5	92990-05600-00	WASHER, PLATE	8	
6	6E5-13641-10-94	MANIFOLD 1	1	
7	6E5-13552-00-00	.NOZZLE	4	
8	624-14485-00-00	.PIPE, JOINT	5	
9	6E5-11370-00-00	.CHECK VALVE ASSY	4	
10	90445-07M28-00	.HOSE (L70)	4	
11	90445-07M24-00	HOSE (L240)	2	
12	90445-07M46-00	HOSE (L360)	2	
13	90116-06M30-00	BOLT, STUD	8	
14	6E5-13645-A1-00	GASKET, MANIFOLD 1	1	
15	97313-06025-00	BOLT	12	
16	92990-06600-00	WASHER, PLATE	12	
17	90465-08028-00	CLAMP	1	
18	97013-06012-00	BOLT	1	
19	6E5-14198-A1-00	GASKET	2	
20	95380-06600-00	NUT, HEXAGON	8	
21	92995-06100-00	WASHER, SPRING	8	
22	6E5-41217-01-00	ROD, ACCEL. LEVER	1	
23	6E5-41256-01-00	ROD, CHOKE 1	1	
24	661-41262-02-00	JOINT, CHOKE LEVER	3	
25	6N7-41271-00-00	KNOB, CHOKE	1	
26	689-41273-00-00	GROMMET	1	
27	6N7-14440-00-00	SILENCER ASSEMBLY, INTAKE	1	
28	6E5-1441K-00-00	EMBLEM	1	
29	90445-07M08-00	HOSE (L220)	1	
30	6K7-14483-00-00	GASKET	2	
31	90159-06M14-00	SCREW, WITH WASHER	8	

## Part Notes

115TXRQ 1992 / INTAKE

PART NUMBER	NOTE TEXT
92990-06600-00 	OEM: This part number is among the Top 100 Most Popular Marine Maintenance Parts as of March 2014.

©2014 Yamaha Motor Corporation, U.S.A. All rights reserved.

115TXRQ 1992 / CARBURETOR

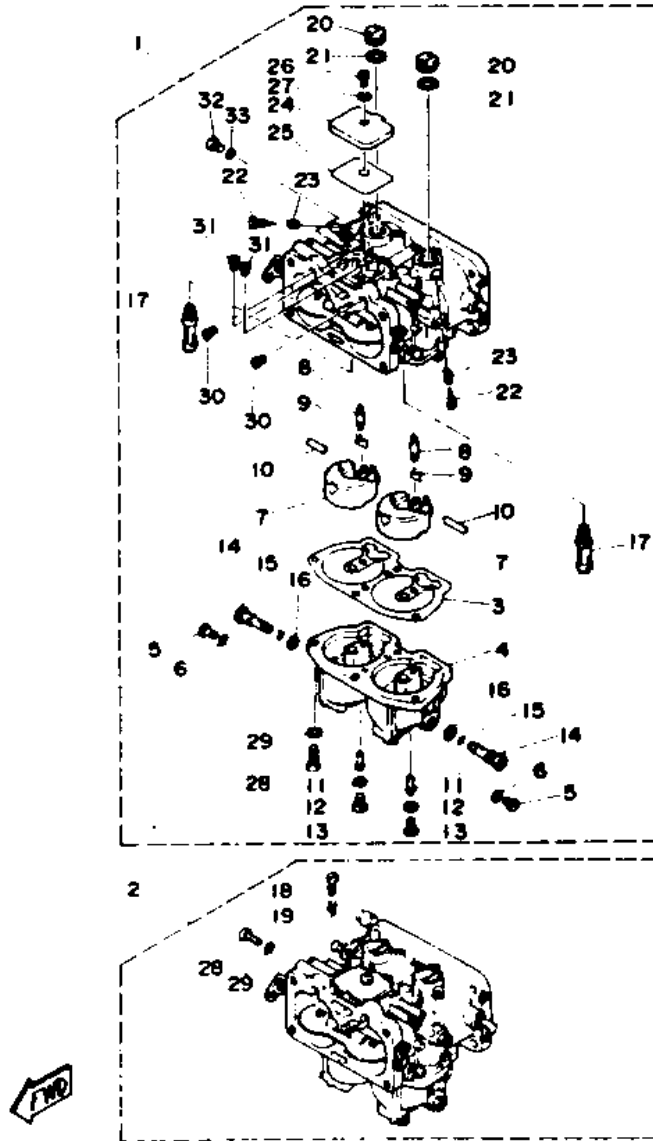

©2014 Yamaha Motor Corporation, U.S.A. All rights reserved.



## Part List

115TXRQ 1992 / CARBURETOR

REF - NO	PART NUMBER	PART NAME	QUANTITY	REMARKS
1	6E5-14301-13-00	CARBURETOR ASSEMBLY 1	1	UR 115 MODEL
1	6L1-14301-01-00	CARBURETOR ASSEMBLY 1	1	UR 130 MODEL
2	6L1-14302-01-00	CARBURETOR ASSEMBLY 2	1	UR 130 MODEL
2	6E5-14302-13-00	CARBURETOR ASSEMBLY 2	1	UR 115 MODEL
3	6E5-14384-03-00	.GASKET, FLOAT CHAMBER	2	
4	6E5-14381-03-00	.BODY, FLOAT CHAMBER	2	
5	6E5-14383-01-00	.SCREW, DRAIN	4	
6	6J8-14995-00-00	.GASKET	4	
7	6E5-14385-02-00	.FLOAT	4	
8	6E5-14546-00-00	.VALVE, NEEDLE	4	
9	6E5-14159-00-00	.CLIP	4	
10	6E5-14386-02-00	.PIN, FLOAT	4	
11	6E5-1492F-40-00	.JET, AIR SLOW (#80)	3	UR 130 MODEL
11	6E5-1492F-39-00	.JET, AIR SLOW (#78)	4	UR 115 MODEL
12	6E5-14397-00-00	.O-RING	4	
13	6E5-14394-00-00	.PLUG, SLOW JET	4	
14	6E5-1492E-90-00	.JET, MAIN (#180)	4	
15	6E5-14997-00-00	.O-RING	4	
16	6E5-14398-01-00	.GASKET	4	
17	6E5-1492A-00-00	.NOZZLE, MAIN	4	
18	6E5-14321-00-00	.SCREW, THROTTLE	1	
19	6J8-14334-00-00	.SPRING, THROTTLE	1	
20	6E5-14328-01-00	.PLUG	4	
21	6E5-14979-00-00	.GASKET	4	
22	6E5-14323-03-00	.SCREW, AIR ADJUSTING	4	
23	6E5-14223-00-00	.SPRING, AIR ADJUSTING	4	
24	6E5-14527-01-00	.PLATE	2	
25	6E5-14959-01-00	.GASKET	2	
26	97980-05108-00	.SCREW, WITH WASHER	2	
27	92990-05100-00	.WASHER, SPRING	2	
28	98580-05016-00	.SCREW, PAN HEAD	9	
29	92990-05100-00	.WASHER, SPRING	9	
30	61A-1492H-12-00	.JET, SLOW AIR BLEED (#60)	4	
31	61A-1492G-58-00	.JET, MAIN AIR BLEED	4	UR 115 MODEL
31	61A-1492G-44-00	.JET, MAIN AIR BLEED	4	UR 130 MODEL
32	6E5-14324-00-00	.SCREW, FLAT HEAD	2	
33	6J8-14995-00-00	.GASKET	2	

115TXRQ 1992 / FUEL SYSTEM

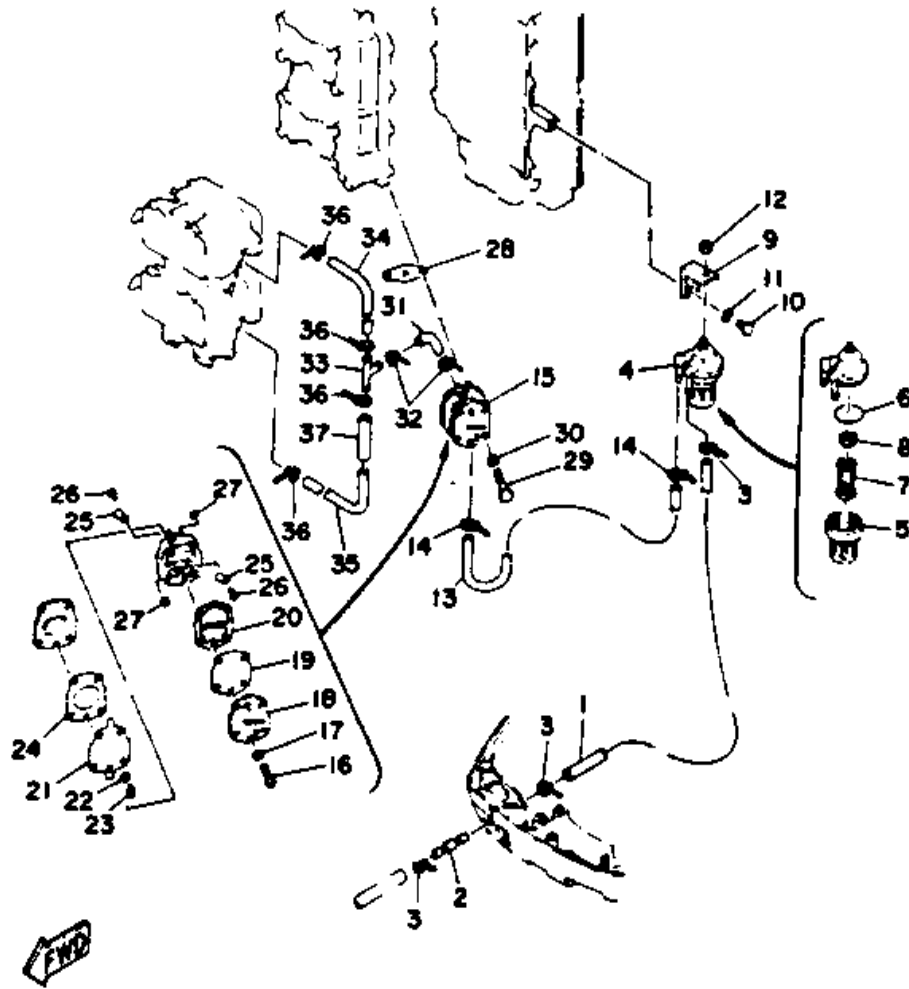

©2014 Yamaha Motor Corporation, U.S.A. All rights reserved.



## Part List

115TXRQ 1992 / FUEL SYSTEM

REF - NO	PART NUMBER	PART NAME	QUANTITY	REMARKS
1	6N7-24313-00-00	PIPE 3	1	
2	6R3-24377-00-00	PIPE, JOINT 2	1	
3	90465-11M10-00	CLAMP	3	
4	6E5-24560-00-00	FILTER ASSY	1	
5	655-24521-01-00	.CUP, FILTER	1	
6	93210-37M25-00	.O-RING	1	
7	6F5-24563-00-00	.ELEMENT, FILTER	1	
8	655-24564-00-00	.GASKET	1	
9	6E5-24566-00-00	BRACKET, FILTER	1	
10	97313-06014-00	BOLT, HEXAGON	1	
11	92995-06100-00	WASHER, SPRING	1	
12	95380-08600-00	NUT	1	
13	6E5-24314-01-00	PIPE 4	1	
14	90465-11M10-00	CLAMP	2	
15	6E5-24410-03-00	FUEL PUMP ASSY	1	
16	98580-05035-00	.SCREW, PAN HEAD	3	
17	92990-05600-00	.WASHER, PLATE	3	
18	6E5-24413-00-00	.BODY 2	1	
19	6E5-24471-00-00	.DIAPHRAGM	1	
20	6E5-24435-00-00	.GASKET, BODY 2	1	
21	6E5-24411-00-00	.DIAPHRAGM	1	
22	648-24424-00-00	.SEAT, SPRING	1	
23	6E5-24423-00-00	.SPRING, DIAPHRAGM	1	
24	6E5-24434-02-00	.GASKET, BODY	1	
25	6A0-24421-01-00	.VALVE, CHECK	4	
26	6A0-14325-00-00	.SCREW, PAN HEAD	4	
27	95380-03600-00	.NUT	4	
28	650-24431-A0-00	GASKET, FUEL PUMP 1	1	
29	97395-06050-00	BOLT	2	
30	92990-06600-00	WASHER, PLATE	2	
31	6G5-24316-10-00	PIPE 6	1	
32	90465-11M10-00	CLAMP	2	
33	6E5-24376-10-00	PIPE, JOINT 1	1	
34	6G5-24318-10-00	PIPE, OVERFLOW	1	
35	6G5-24319-10-00	PIPE, OIL	1	
36	90465-11M10-00	CLAMP	4	
37	90446-15M07-00	HOSE (L60)	1	

## Part Notes

115TXRQ 1992 / FUEL SYSTEM

PART NUMBER	NOTE TEXT
6E5-24410-03-00 	OEM: This part number is among the Top 100 Most Popular Marine Maintenance Parts as of March 2014.
650-24431-A0-00 	OEM: This part number is among the Top 100 Most Popular Marine Maintenance Parts as of March 2014.
92990-06600-00 	OEM: This part number is among the Top 100 Most Popular Marine Maintenance Parts as of March 2014.

©2014 Yamaha Motor Corporation, U.S.A. All rights reserved.

115TXRQ 1992 / FUEL TANK

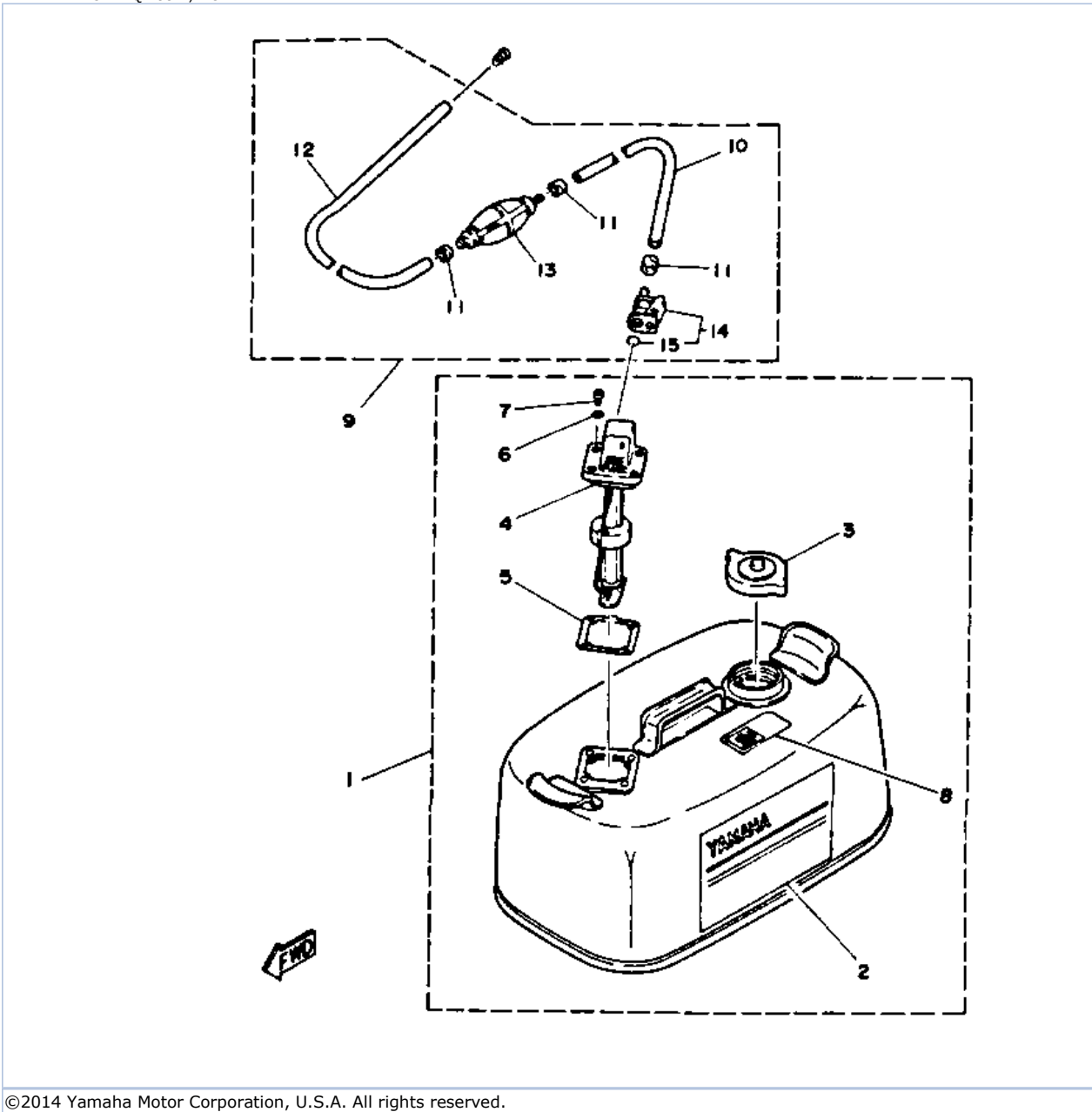

©2014 Yamaha Motor Corporation, U.S.A. All rights reserved.

## Part List

115TXRQ 1992 / FUEL TANK

REF - NO	PART NUMBER	PART NAME	QUANTITY	REMARKS
1	6Y1-W2420-42-24	FUEL TANK ASSEMBLY	1	
2	6Y1-24244-20-00	.GRAPHIC, SIDE	1	
3	6Y1-24610-00-00	.CAP ASSEMBLY	1	
4	6Y1-24260-02-00	.FUEL METER ASSEMBLY	1	
5	6Y1-24268-00-00	.GASKET, FUEL METER	1	
6	6Y1-24329-00-00	.SEAL	4	
7	98586-05016-00	.SCREW, PAN HEAD	4	
8	6Y1-24256-50-00	.GRAPHIC, FUEL TANK	1	
9	6Y2-24306-40-00	FUEL PIPE COMP. 1	1	
10	90445-13M01-00	.HOSE (L2050)	1	
11	6E5-24351-51-00	.BAND 1	3	
12	90445-13M35-00	.HOSE (L250)	1	
13	6Y2-24360-51-00	.PRIMER PUMP ASSY	1	
14	6Y2-24305-02-00	.FUEL PIPE JOINT COMP 2	1	
15	93210-08287-00	..O-RING	1	

115TXRQ 1992 / TOP COWLING

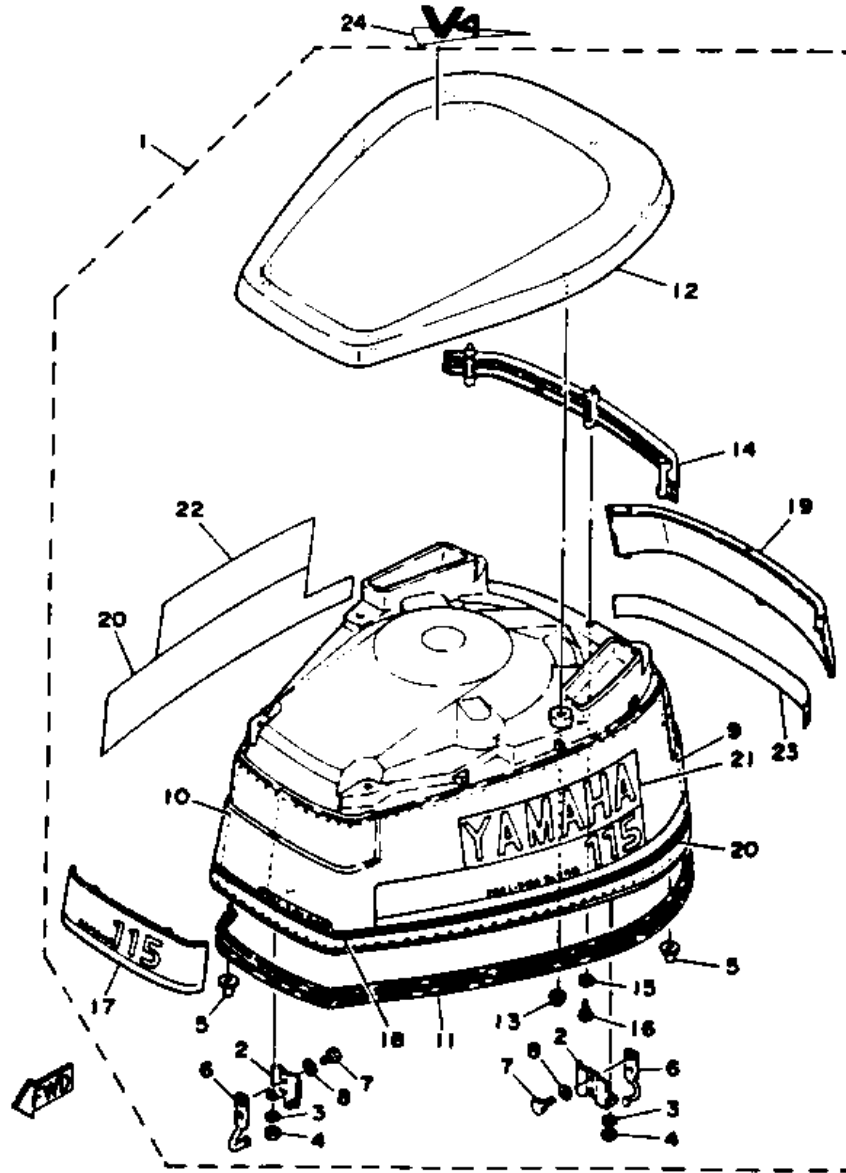

©2014 Yamaha Motor Corporation, U.S.A. All rights reserved.

## Part List

115TXRQ 1992 / TOP COWLING

REF - NO	PART NUMBER	PART NAME	QUANTITY	REMARKS
1	6N6-42610-71-EK	TOP COWLING ASSEMBLY.	1	UR 115 MODEL
1	6N7-42610-71-EK	TOP COWLING ASSEMBLY	1	UR 130 MODEL
2	6R3-42647-00-00	.HOLDER, CLAMP BAND	2	
3	92995-06100-00	.WASHER, SPRING	4	
4	95380-06600-00	.NUT, HEXAGON	4	
5	6R3-42662-00-00	.DAMPER	3	
6	6R3-42814-00-00	.HOOK, CLAMP	2	
7	97395-06012-00	.BOLT	4	
8	92990-06600-00	.WASHER, PLATE	4	
9	6N7-42619-00-00	.DAMPER, FORM	1	
10	6N7-42627-00-00	.DAMPER, FORM	1	
11	6R3-42615-01-00	.SEAL	1	
12	6N7-42613-00-EK	.MOLDING, AIR DUCT	1	
13	90179-06M24-00	.NUT	6	
14	6N7-42636-00-00	.LOUVER 2	1	
15	92990-04600-00	.WASHER, PLATE	3	
16	97780-40120-00	.SCREW, TAPPING	3	
17	6N7-42686-00-00	.EMBLEM, FRONT	1	UR 130 MODEL
17	6N6-42686-00-00	.EMBLEM, FRONT	1	UR 115 MODEL
18	6N7-42677-40-00	.GRAPHIC, FRONT	1	
19	6N7-42687-00-00	.EMBLEM, REAR	1	UR 130 MODEL
19	6N6-42687-00-00	.EMBLEM, REAR	1	UR 115 MODEL
20	6N6-W0070-40-00	.GRAPHIC SET	1	UR 115 MODEL
20	6N7-W0070-40-00	.GRAPHIC SET	1	UR 130 MODEL
21	6N7-42681-40-00	.MARK, COWLING 1	1	
22	6N7-42682-40-00	.MARK, COWLING 2	1	
23	6N7-42678-40-00	.GRAPHIC, REAR	1	
24	6N7-42683-40-00	MARK, COWLING	1	

## Part Notes

115TXRQ 1992 / TOP COWLING

PART NUMBER	NOTE TEXT
92990-06600-00 	OEM: This part number is among the Top 100 Most Popular Marine Maintenance Parts as of March 2014.

©2014 Yamaha Motor Corporation, U.S.A. All rights reserved.

115TXRQ 1992 / BOTTOM COWLING

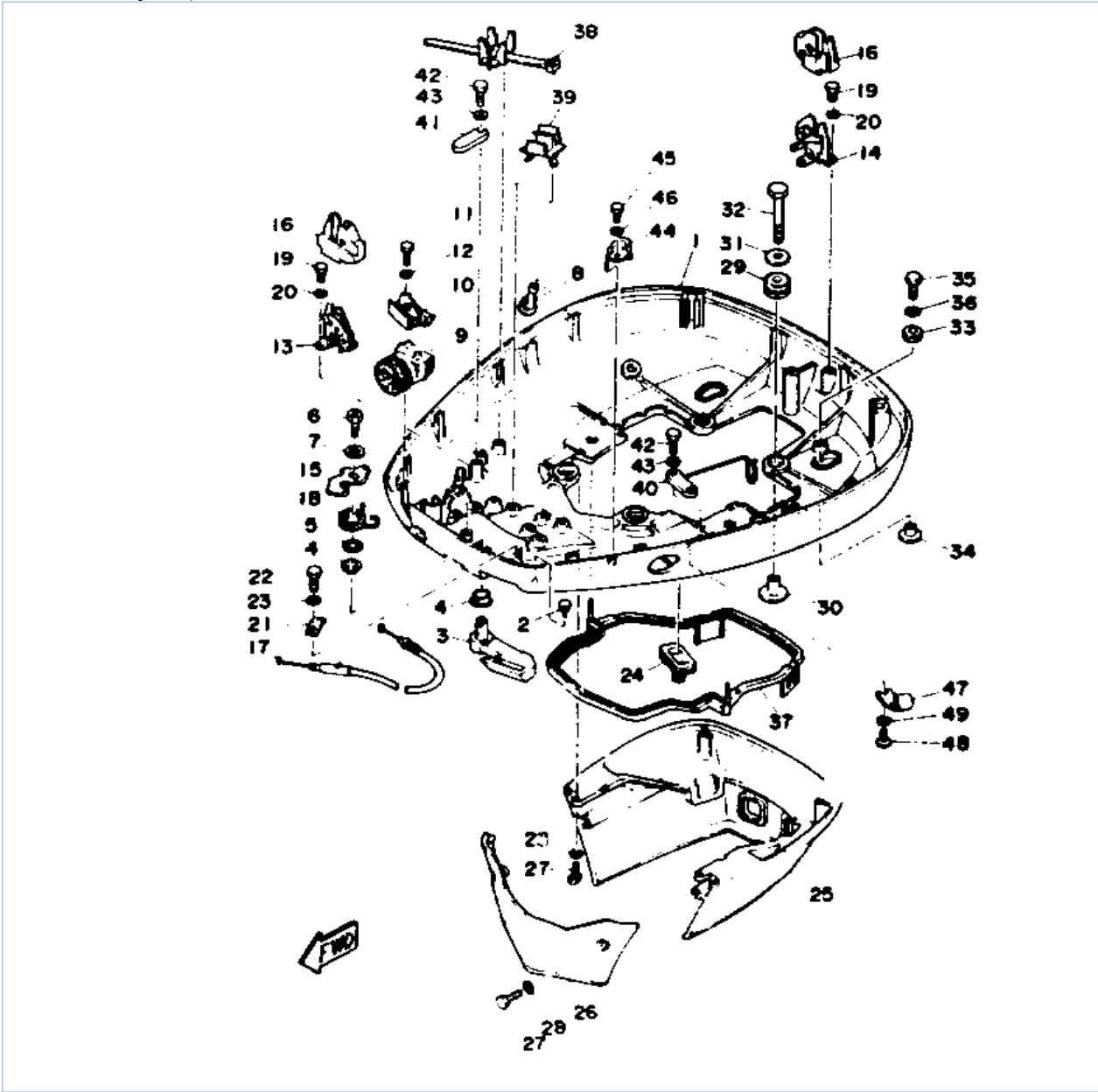

©2014 Yamaha Motor Corporation, U.S.A. All rights reserved.



## Part List

115TXRQ 1992 / BOTTOM COWLING

REF - NO	PART NUMBER	PART NAME	QUANTITY	REMARKS
1	6N7-42711-40-EK	BOTTOM COWLING	1	
2	6H4-42748-00-00	GROMMET	1	
3	6N7-42815-00-EK	LEVER, CLAMP 1	1	
4	90386-13M88-00	BUSH	2	
5	90206-13M10-00	WASHER, WAVE	1	
6	90109-08M45-00	BOLT	1	
7	92990-08200-00	WASHER, PLAIN	1	
8	6E5-44391-00-00	NIPPLE, HOSE	1	
9	6N7-42725-20-00	GROMMET	1	
10	6N7-42738-01-5B	PLATE, FITTING	1	
11	97395-06016-00	BOLT, HEX	2	
12	92990-06600-00	WASHER, PLATE	2	
13	6R3-42824-00-00	BASE, CLAMP LEVER	1	
14	6R3-42811-00-00	STAY	1	
15	6R3-42816-00-00	LEVER, CLAMP	1	
16	6R3-42851-00-00	COVER, CLAMP	2	
17	6R3-42850-00-00	WIRE, COMPLETE	2	
18	6R3-42813-00-00	SPRING, CLAMP LEVER	1	
19	97395-06016-00	BOLT, HEX	4	
20	92990-06600-00	WASHER, PLATE	4	
21	6R3-42828-00-00	PLATE, CLAMP	1	
22	97395-06010-00	BOLT	1	
23	92990-06600-00	WASHER, PLATE	1	
24	688-42726-10-00	GROMMET	1	
25	6N7-42741-00-EK	APRON 1	1	
26	6R3-42771-00-EK	APRON 2	1	
27	97395-06020-00	BOLT, HEXAGON	4	
28	92990-06600-00	WASHER, PLATE	4	
29	90480-22M15-00	GROMMET	4	
30	90387-08M37-00	COLLAR	4	
31	90201-08M54-00	WASHER, PLATE	4	
32	97090-08035-00	BOLT	4	
33	90480-14M45-00	GROMMET	2	
34	90387-06M52-00	COLLAR	2	
35	97395-06025-00	BOLT	2	
36	90201-06M02-00	WASHER, PLATE	2	
37	6E5-42716-00-00	RUBBER, SEAL 1	1	
38	688-82594-00-00	CLAMP	1	
39	6E5-82594-00-00	CLAMP	4	
40	6K7-82588-00-00	PLATE	1	
41	6E5-82588-00-00	PLATE	1	
42	97395-06020-00	BOLT, HEXAGON	2	
43	92990-06600-00	WASHER, PLATE	2	
44	90465-12M25-00	CLAMP	1	
45	97395-06012-00	BOLT	1	
46	92990-06600-00	WASHER, PLATE	1	
47	6E5-24367-10-00	CLAMP, FUEL PIPE 2	1	
48	90157-06M01-00	SCREW, PAN HEAD	1	
49	92990-06600-00	WASHER, PLATE	1	

## Part Notes

115TXRQ 1992 / BOTTOM COWLING

PART NUMBER	NOTE TEXT
-------------	-----------

92990-06600-00		OEM: This part number is among the Top 100 Most Popular Marine Maintenance Parts as of March 2014.
92990-06600-00		OEM: This part number is among the Top 100 Most Popular Marine Maintenance Parts as of March 2014.
92990-06600-00		OEM: This part number is among the Top 100 Most Popular Marine Maintenance Parts as of March 2014.
92990-06600-00		OEM: This part number is among the Top 100 Most Popular Marine Maintenance Parts as of March 2014.
92990-06600-00		OEM: This part number is among the Top 100 Most Popular Marine Maintenance Parts as of March 2014.
92990-06600-00		OEM: This part number is among the Top 100 Most Popular Marine Maintenance Parts as of March 2014.
92990-06600-00		OEM: This part number is among the Top 100 Most Popular Marine Maintenance Parts as of March 2014.

©2014 Yamaha Motor Corporation, U.S.A. All rights reserved.

115TXRQ 1992 / BRACKET 1

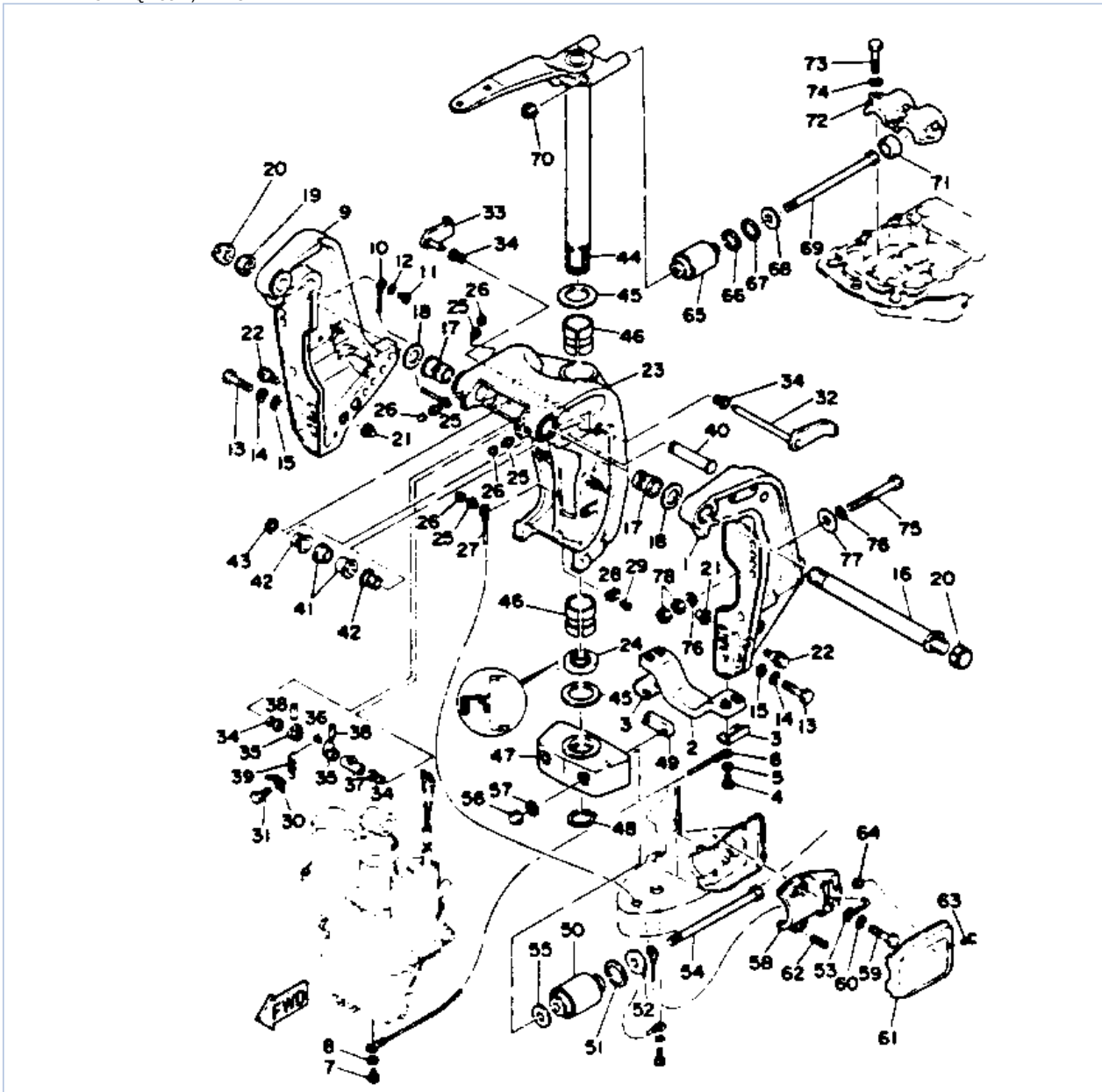

©2014 Yamaha Motor Corporation, U.S.A. All rights reserved.

## Part List



115TXRQ 1992 / BRACKET 1

REF - NO	PART NUMBER	PART NAME	QUANTITY	REMARKS
1	6G5-43111-01-EK	BRACKET CLAMP	1	
2	6G5-45251-01-00	ANODE	1	
3	6G5-44526-00-00	PLATE	2	
4	97395-06030-00	BOLT	4	
5	92995-06100-00	WASHER, SPRING	4	
6	6E5-82148-00-00	WIRE, LEAD 4	4	
7	97395-06010-00	BOLT	1	
8	92990-06600-00	WASHER, PLATE	1	
9	6G5-43112-01-EK	BRACKET, CLAMP	1	
10	6E5-82148-00-00	WIRE, LEAD 4	1	
11	98580-06012-00	SCREW, PAN HEAD	1	
12	92990-06600-00	WASHER, PLATE	1	
13	97395-10050-00	BOLT	6	
14	92990-10100-00	WASHER, SPRING	6	
15	92990-10600-00	WASHER, PLATE	6	
16	6E5-43131-01-00	BOLT, CLAMP BRACKET	1	
17	90386-25M31-00	BUSH	2	
18	90201-26M59-00	WASHER, PLATE	2	
19	90185-22043-00	NUT, SELF-LOCKING	1	
20	6G5-43145-00-00	CAP, CLAMP BRACKET	2	
21	6G5-43164-00-00	ROD, TILT LOCK	2	
22	90109-12M35-00	BOLT	2	
23	6G5-43311-00-EK	BRACKET, SWIVEL	1	UR LONG
23	6G5-43311-20-EK	BRACKET, SWIVEL	1	UR ULTRA LONG
24	93109-38M02-00	OIL SEAL	1	
25	93700-06004-00	NIPPLE, GREASE	5	
26	663-45119-00-00	CAP, GREASE NIPPLE	5	
27	6E5-82147-00-00	WIRE, LEAD 5	1	UR LONG
27	6E5-82147-20-00	WIRE, LEAD 5	1	UR ULTRA LONG
28	90464-11M18-00	CLAMP	1	
29	98580-04008-00	.SCREW, PAN HEAD	1	
30	6G5-43144-00-00	HOOK, SPRING	1	
31	97395-06010-00	BOLT	1	
32	6G5-43181-02-00	LEVER, TILT STOP 1	1	
33	6G5-43185-02-00	LEVER, TILT STOP 2	1	
34	90386-10M16-00	BUSH	4	
35	6G5-43148-00-00	COLLAR, DISTANCE	2	
36	90249-06M19-00	PIN	1	
37	90387-10M02-00	COLLAR	1	
38	91690-30020-00	PIN, SPRING	2	
39	90506-14M24-00	SPRING, TENSION	1	
40	6E5-43126-02-00	PIN, UPPER SHOCK MOUNT	1	
41	90386-18M63-00	BUSH	2	
42	90386-18M14-00	BUSH	2	
43	93410-18M02-00	CIRCLIP	1	
44	6E5-42510-03-EK	STEERING BRACKET ASSY	1	UR LONG
44	6E5-42510-23-EK	STEERING BRACKET ASSY	1	UR ULTRA LONG
45	90201-38M60-00	WASHER, PLATE	2	
46	90386-38M32-00	BUSH	2	
47	6G5-44551-00-EK	HOUSING, LOWER MOUNT	1	
48	93410-37M04-00	CIRCLIP	1	
49	6E5-44575-00-00	DAMPER, LOWER MOUNT RUBBER	1	
50	6E5-44555-00-94	MOUNT DAMPER, LOWER	2	

		SIDE		
51	90202-32M19-00	WASHER, PLATE	2	
52	90201-16M55-00	WASHER, PLATE	2	
53	6E5-82149-00-00	WIRE, LEAD 3	1	
54	90109-14M34-00	BOLT	2	
55	90201-15M58-00	WASHER, PLATE	2	
56	95380-14800-00	NUT	2	
57	92990-14600-00	WASHER	2	
58	6E5-44552-00-94	HOUSING, LOWER MOUNT RUBBER	2	
59	97395-10045-00	BOLT	4	
60	92990-10100-00	WASHER, SPRING	4	
61	6E5-44553-00-EK	COVER, LOWER MOUNT	2	
62	90501-16M28-00	SPRING, COMPRESSION	4	
63	92380-06015-00	SCREW, CYLINDER HEAD	2	
64	90179-06066-00	NUT	2	
65	6E5-44514-00-94	MOUNT DAMPER, UPPER SIDE	2	
66	90201-26M57-00	WASHER, PLATE	2	
67	90202-26M18-00	WASHER, PLATE	2	
68	90201-14M56-00	WASHER, PLATE	2	
69	90109-12M37-00	BOLT	2	
70	90185-12058-00	NUT, SELF-LOCKING	2	
71	663-44575-00-00	DAMPER, LOWER MOUNT RUBBER	2	
72	6E5-44511-00-5B	COVER, UPPER MOUNT	1	
73	97395-10045-00	BOLT	3	
74	92990-10100-00	WASHER, SPRING	3	
75	90101-12M03-00	BOLT (L:115MM)	4	UR
75	90101-12M02-00	BOLT (L:130MM)	4	UR
76	90201-13M01-00	WASHER, PLATE	8	
77	90201-12426-00	WASHER, PLATE	4	
78	95380-12600-00	NUT	8	

## Part Notes

115TXRQ 1992 / BRACKET 1

PART NUMBER		NOTE TEXT
92990-06600-00		OEM: This part number is among the Top 100 Most Popular Marine Maintenance Parts as of March 2014.
92990-06600-00		OEM: This part number is among the Top 100 Most Popular Marine Maintenance Parts as of March 2014.
92990-10600-00		OEM: This part number is among the Top 100 Most Popular Marine Maintenance Parts as of March 2014.

©2014 Yamaha Motor Corporation, U.S.A. All rights reserved.

115TXRQ 1992 / BRACKET 2

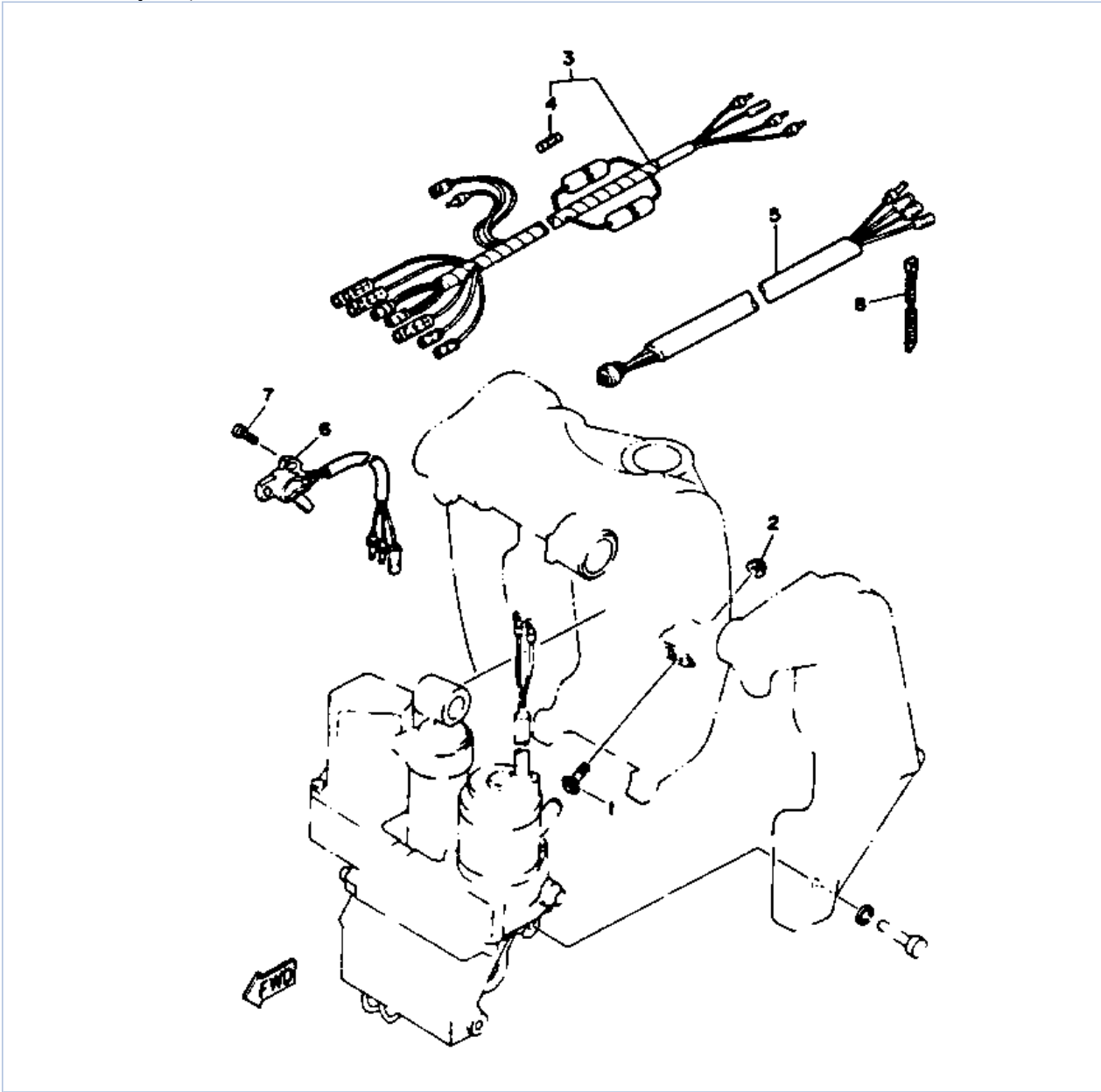

©2014 Yamaha Motor Corporation, U.S.A. All rights reserved.

## Part List

115TXRQ 1992 / BRACKET 2

REF - NO	PART NUMBER	PART NAME	QUANTITY	REMARKS
1	6G5-43376-00-00	BOLT, THRUST RECEIVER	2	
2	95780-10300-00	NUT, FLANGE	2	
3	6Y5-83553-M0-00	WIRE, LEAD (L=2.5M)	1	
4	1E6-82151-00-00	.FUUSE (10A)	2	
5	6E5-82553-10-00	EXTENSION, WIRE HARNESS	1	
6	6R3-83672-01-00	TRIM SENDER	1	
7	98580-06016-00	SCREW, PAN HEAD	2	
8	90465-11M10-00	CLAMP	3	

115TXRQ 1992 / POWER TRIM TILT ASSEMBLY 1

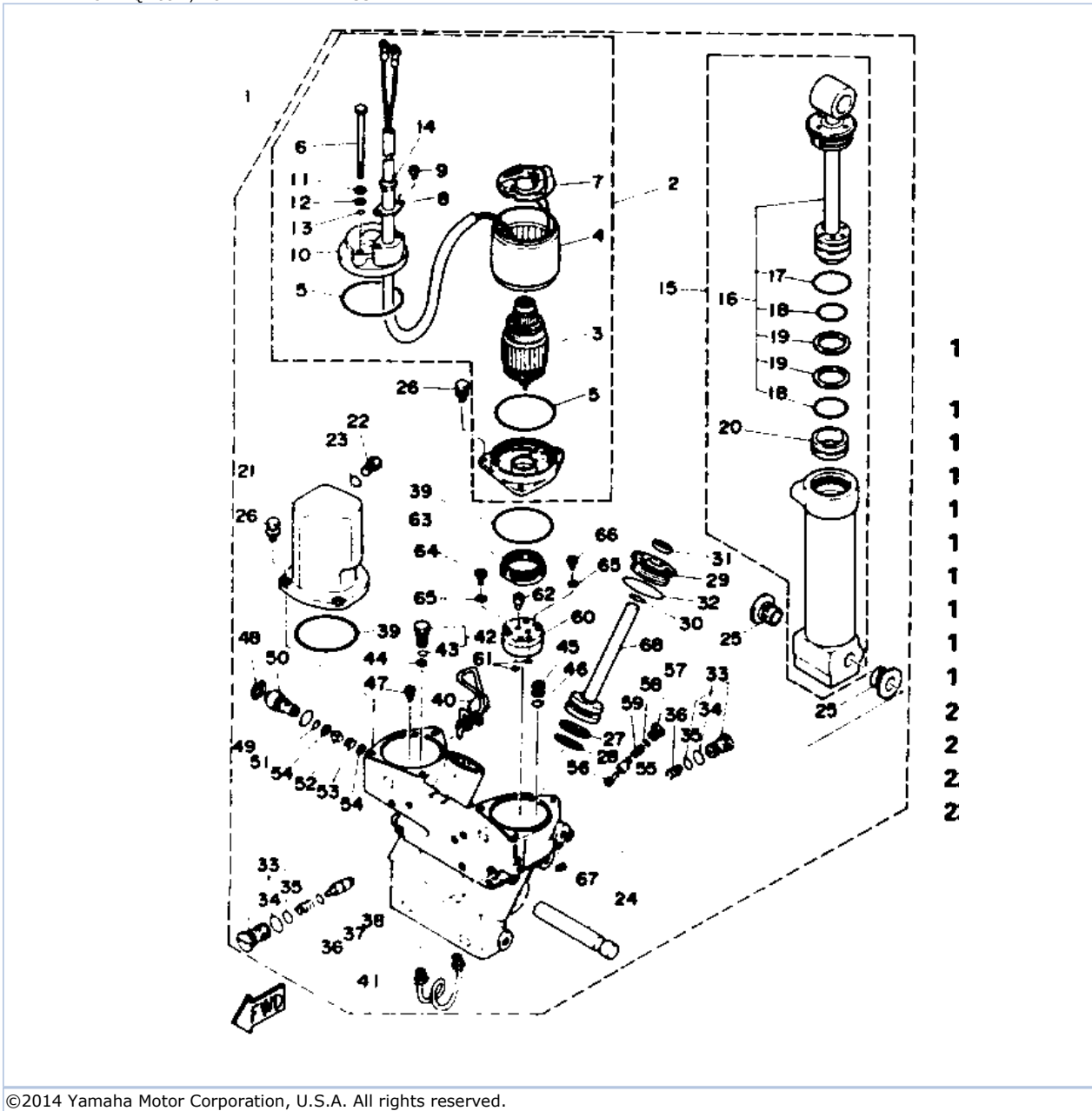

©2014 Yamaha Motor Corporation, U.S.A. All rights reserved.



## Part List

115TXRQ 1992 / POWER TRIM TILT ASSEMBLY 1

REF - NO	PART NUMBER	PART NAME	QUANTITY	REMARKS
1	6G5-43800-05-EK	PWR.TRIM&TILT ASSEMBLY	1	
2	6G5-43880-02-00	.MOTOR ASSEMBLY	1	
3	6G5-43805-01-00	..ARMATURE ASSEMBLY	1	
4	6G5-43804-00-00	..STATOR ASSY	1	
5	6G5-43865-00-00	..O-RING	2	
6	6G5-43887-00-00	..BOLT, THROUGH	2	
7	6G5-43806-00-00	..BRUSH, HOLDER ASSY	1	
8	6G5-43899-00-00	..PLATE, STOPPER	1	
9	6G5-43886-00-00	..BOLT	2	
10	6G5-43884-00-00	..FRAME, COMMUTATOR END	1	
11	6G5-43893-00-00	..WASHER	2	
12	6G5-43889-10-00	..PLATE SEAT	2	
13	6G5-43867-00-00	..O-RING	2	
14	6G5-43885-00-00	..GROMMET	1	
15	6G5-4380E-01-00	.TILT CYLINDER ASSEMBLY	1	
16	6G5-43810-00-00	..PISTON SUB ASSEMBLY	1	
17	6E5-43861-00-00	..O-RING	1	
18	6G5-43862-00-00	..O-RING	2	
19	6E5-43872-00-00	..RING, BACK UP	2	
20	6E5-43814-02-00	..PISTON, FREE	1	
21	6G5-43828-00-00	.BODY, RESERVOIR	1	
22	6E5-43829-00-00	.PLUG, RESERVOIR	1	
23	6E5-43863-00-00	.O-RING	1	
24	6G5-43818-00-00	.PIN, LOWER SHOCK MOUNT	1	
25	90386-18M14-00	.BUSH	2	
26	90119-06M42-00	.BOLT, WITH WASHER	6	
27	6G5-43874-00-00	.RING, BACK UP	2	
28	6G5-43864-00-00	.O-RING	2	
29	6G5-43821-01-00	.SCREW, TRIM CYLINDER END (6G5-43821-00-00)	2	
30	6E5-43865-00-00	.O-RING	2	
31	6E5-43822-01-00	.SEAL, TRIM DUST	2	
32	6G5-43861-00-00	.O-RING	2	
33	6G5-43802-01-00	.VALVE SUB ASSY	2	
34	6E5-43866-00-00	..O-RING	1	
35	6E5-43867-00-00	..O-RING	1	
36	6G5-43894-00-00	.SPRING, SHUTTLE RETURN	2	
37	6E5-43868-00-00	.O-RING	1	
38	6G5-43841-00-00	.PISTON, SHUTTLE	1	
39	6E5-43869-00-00	.O-RING	2	
40	6G5-43835-00-00	.PIPE	1	
41	6G5-43833-00-00	.PIPE	1	
42	6G5-43809-01-00	.SEAT, VALVE COMP 2	1	
43	6E5-43896-00-00	..O-RING	1	
44	6G5-43816-00-00	.FILTER 1	1	
45	6G5-43808-02-00	.SEAT VALVE COMP 1	1	
46	6E5-43883-00-00	.O-RING	1	
47	6G5-43803-00-00	.CASE VALVE COMP	1	
48	6H1-43875-00-00	.RING, SNAP	1	
49	93210-18M75-00	.O-RING	1	
50	6G5-43845-00-00	.SCREW, MANUAL RELEASE	1	
51	93210-10M74-00	.O-RING	1	
52	6E5-4382A-00-00	.ADAPTER 1	1	
53	6E5-43854-01-00	.SPRING, MANUAL RELEASE	1	

54	6E5-43847-00-00	.SEAT, MANUAL VALVE	2	
55	6G5-43849-00-00	.PIN, VALVE SUPPORT	1	
56	6G5-4381A-00-00	.SHAFT	1	
57	6G5-43842-00-00	.SCREW, VALVE SEAT	1	
58	6G5-43866-00-00	.O-RING	1	
59	6E5-43824-01-00	.SPRING, COMPRESSION	1	
60	6G5-43830-01-00	.GEAR PUMP ASSEMBLY	1	
61	6G5-43863-00-00	.O-RING	2	
62	6G5-43831-01-00	.CONNECTOR, SHAFT	1	
63	6G5-43817-00-00	.FILTER 2	1	
64	6G5-43878-01-00	.BOLT, SOCKET	2	
65	90201-05M00-00	.WASHER, PLATE	3	
66	6G5-43888-01-00	.BOLT, SOCKET	1	
67	6G5-43878-10-00	.BOLT, SOCKET	1	
68	6G5-43820-00-00	.PISTON, SUB ASSY	2	

## Part Notes

115TXRQ 1992 / POWER TRIM TILT ASSEMBLY 1

PART NUMBER		NOTE TEXT
6G5-43864-00-00		OEM: This part number is among the Top 100 Most Popular Marine Maintenance Parts as of March 2014.

©2014 Yamaha Motor Corporation, U.S.A. All rights reserved.

115TXRQ 1992 / CONTROL ENGINE

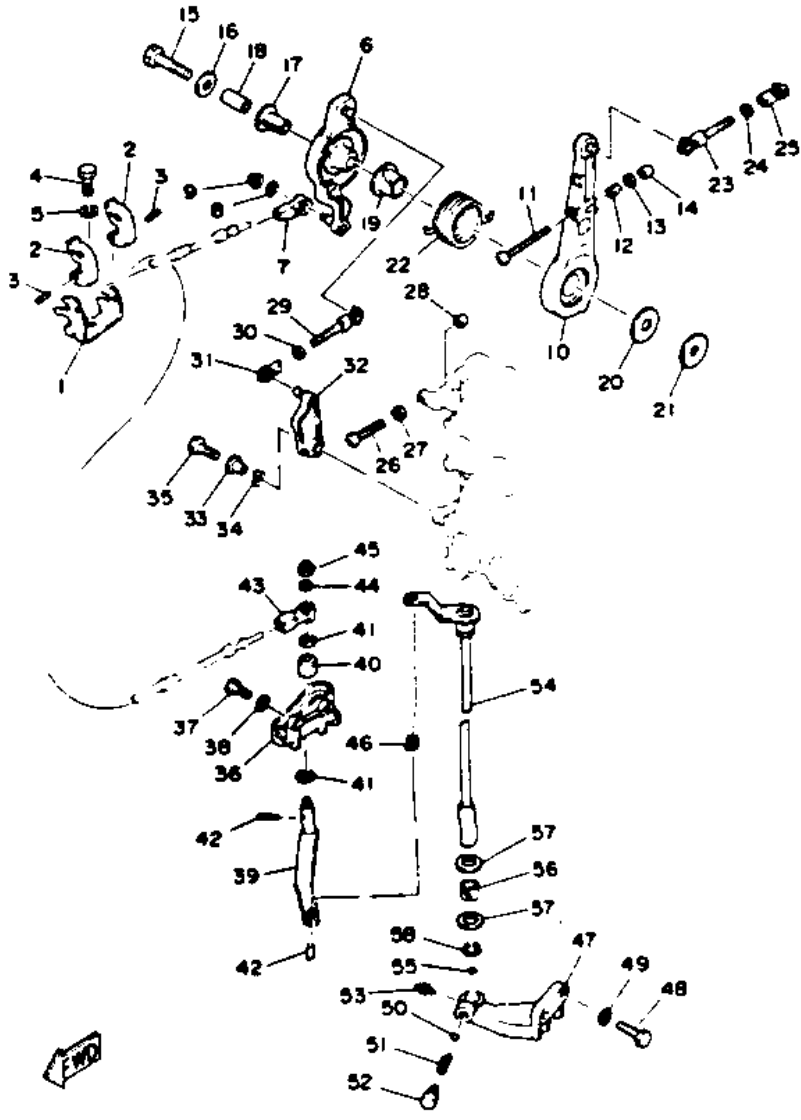

©2014 Yamaha Motor Corporation, U.S.A. All rights reserved.

## Part List





115TXRQ 1992 / CONTROL ENGINE

REF - NO	PART NUMBER	PART NAME	QUANTITY	REMARKS
1	6E5-48531-00-00	BRACKET, REMOTE CONTROL 1	1	
2	6E5-48538-00-00	CLAMP, CABLE	2	
3	91690-30012-00	.PIN, SPRING	2	
4	97395-08020-00	BOLT, HEXAGON	1	
5	92990-08100-00	WASHER, SPRING	1	
6	6E5-41632-01-94	LEVER, MAG.CONTROLMAGNETO CONTROL	1	
7	6E5-48344-00-00	CABLE END, REMOTE CONTROL	1	
8	92990-06200-00	WASHER, PLAIN	1	
9	90185-06M07-00	NUT, SELF-LOCKING	1	
10	6E5-41631-01-94	LEVER, MAGNETO CONTROL	1	
11	90157-06013-00	SCREW, PAN HEAD	1	
12	90501-16M12-00	SPRING, COMPRESSION	1	
13	95380-06600-00	NUT, HEXAGON	1	
14	688-44194-00-00	CAP	1	
15	97313-08045-00	BOLT, HEXAGON	1	
16	90201-08M54-00	WASHER, PLATE	1	
17	90386-12089-00	BUSH	1	
18	90387-08M16-00	COLLAR	1	
19	90386-22M13-00	BUSH	1	
20	90202-12092-00	WASHER, PLATE	1	
21	90201-08M13-00	WASHER, PLATE	1	
22	90508-29M12-00	SPRING, TORSION	1	
23	6E5-41636-01-00	ROD, MAGNETO CONTROL	1	
24	95380-05600-00	NUT	1	
25	6H1-41237-00-00	JOINT, LINK	1	
26	90157-06013-00	SCREW, PAN HEAD	1	
27	95380-06600-00	NUT, HEXAGON	1	
28	688-44194-00-00	CAP	1	
29	688-41636-00-00	ROD, MAGNETO CONTROL	1	
30	95380-05600-00	NUT	1	
31	6H1-41237-00-00	JOINT, LINK	1	
32	6E5-41213-00-00	CAM, ACCEL.	1	
33	90387-06M29-00	COLLAR	1	
34	90206-10M04-00	WASHER, WAVE	1	
35	97395-06025-00	BOLT	1	
36	6E5-44117-00-94	BRACKET	1	
37	97313-06020-00	BOLT, HEXAGON	2	
38	92990-06600-00	WASHER, PLATE	2	
39	6E5-44121-00-00	LEVER, SHIFT ROD	1	
40	6E5-44122-00-00	BUSHING, SHIFT ROD LEVER	1	
41	90202-08M20-00	WASHER, PLATE	2	
42	90468-18008-00	CLIP	2	
43	6E5-48344-00-00	CABLE END, REMOTE CONTROL	1	
44	92990-06200-00	WASHER, PLAIN	1	
45	90185-06M07-00	NUT, SELF-LOCKING	1	
46	90386-06M12-00	BUSH	1	
47	6E5-44118-01-94	BRACKET	1	
48	97313-08030-00	BOLT	2	
49	92990-08600-00	..WASHER, PLATE	2	
50	93501-04M02-00	BALL	1	

51	90501-12082-00	SPRING, COMPRESSION	1	
52	648-42715-00-00	BUSHING	1	
53	93700-06004-00	NIPPLE, GREASE	1	
54	6E5-44120-02-00	HANDEL, GEAR SHIFT ASSEMBLY	1	UR LONG
54	6E5-44120-22-00	HANDEL, GEAR SHIFT ASSEMBLY	1	UR ULTRA LONG
55	93210-09350-00	O-RING	1	
56	90386-16M66-00	BUSH	1	
57	90202-16061-00	WASHER, PLATE	2	
58	99009-16400-00	.CIRCLIP	1	

## Part Notes

115TXRQ 1992 / CONTROL ENGINE

PART NUMBER		NOTE TEXT
6H1-41237-00-00		OEM: This part number is among the Top 100 Most Popular Marine Maintenance Parts as of March 2014.
6H1-41237-00-00		OEM: This part number is among the Top 100 Most Popular Marine Maintenance Parts as of March 2014.
92990-06600-00		OEM: This part number is among the Top 100 Most Popular Marine Maintenance Parts as of March 2014.
90468-18008-00		OEM: This part number is among the Top 100 Most Popular Marine Maintenance Parts as of March 2014.

©2014 Yamaha Motor Corporation, U.S.A. All rights reserved.

115TXRQ 1992 / UPPER CASING

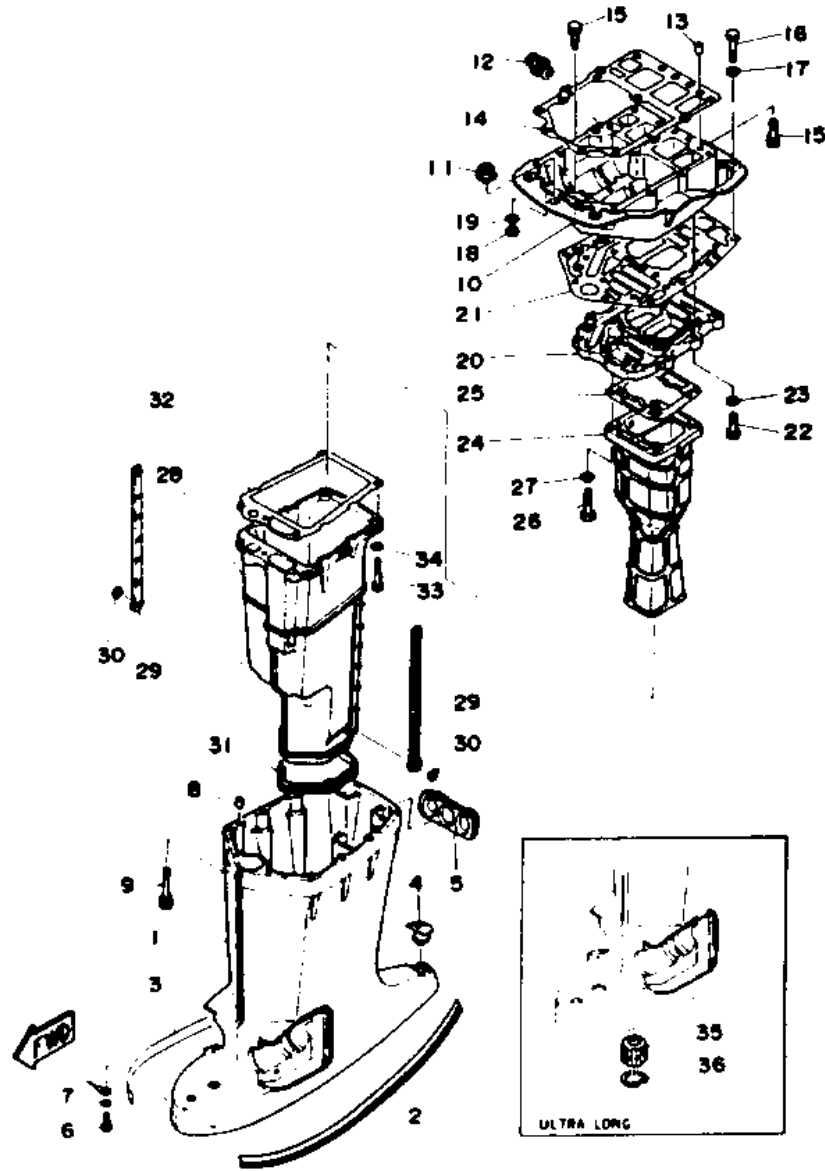

©2014 Yamaha Motor Corporation, U.S.A. All rights reserved.

## Part List

115TXRQ 1992 / UPPER CASING

REF - NO	PART NUMBER	PART NAME	QUANTITY	REMARKS
1	6E5-45111-00-EK	CASING, UPPER	1	UR LONG
1	6E5-45111-20-EK	CASING, UPPER	1	UR ULTRA LONG
2	6R3-42791-40-00	MARK	1	
3	6R3-42792-40-00	MARK 2	1	
4	6E5-45155-00-00	CAP	1	
5	6E5-42769-00-00	SEAL, RUBBER	1	
6	97395-06010-00	BOLT	1	
7	92990-06600-00	WASHER, PLATE	1	
8	93608-12M05-00	PIN, DOWEL	2	
9	90119-08M78-00	BOLT, WITH WASHER	6	
10	6G5-41137-00-94	GUIDE, EXHAUST	1	
11	6E5-42724-00-00	GROMMET	1	
12	6G5-12581-00-00	JOINT, HOSE 1	1	
13	93608-12M05-00	PIN, DOWEL	2	
14	6G5-45113-A0-00	GASKET, UPPER CASING	1	
15	90119-08M79-00	BOLT, WITH WASHER	6	
16	97395-08045-00	BOLT	2	
17	92990-08100-00	WASHER, SPRING	2	
18	95380-08700-00	NUT	2	
19	92990-08100-00	WASHER, SPRING	2	
20	6G5-41131-00-5B	MANIFOLD, EXHAUST 1 (6G5-41131-00-9M)	1	
21	6G5-45114-A0-00	GASKET, UPPER CASING	1	
22	97395-08030-00	BOLT	4	
23	92990-08600-00	..WASHER, PLATE	4	
24	6L1-41132-00-5B	MANIFOLD, EXHAUST	1	UR 130 MODEL
24	6E5-41132-10-5B	MANIFOLD, EXHAUST	1	UR 115 MODEL
25	6G5-41134-00-00	GASKET, EXHAUST MANIFOLD	1	UR 130 MODEL
25	6E5-41134-A0-00	.GASKET, EXHAUST MANIFOLD	1	UR 115 UR 115
26	97395-08045-00	BOLT	4	
27	92990-08600-00	..WASHER, PLATE	4	
28	6E5-14711-00-5B	MUFFLER 1 (6E5-14711-00- 9M)	1	
29	6E5-14737-00-00	DAMPER, MUFFLER	2	
30	90183-05M02-00	NUT, SPRING	2	
31	6E5-45123-00-00	.GASKET, MUFFLER	1	
32	6E5-41135-00-00	GASKET, EXHAUST MANIFOLD	1	
33	97395-08045-00	BOLT	5	
34	92990-08600-00	..WASHER, PLATE	5	
35	6E5-45318-00-00	BUSHING, DRIVE SHAFT	1	ULTRA LONG
36	93420-36M01-00	CIRCLIP	1	ULTRA LONG

## Part Notes

115TXRQ 1992 / UPPER CASING

PART NUMBER	NOTE TEXT
92990-06600-00 	OEM: This part number is among the Top 100 Most Popular Marine Maintenance Parts as of March 2014.

©2014 Yamaha Motor Corporation, U.S.A. All rights reserved.

115TXRQ 1992 / LOWER DRIVE 1

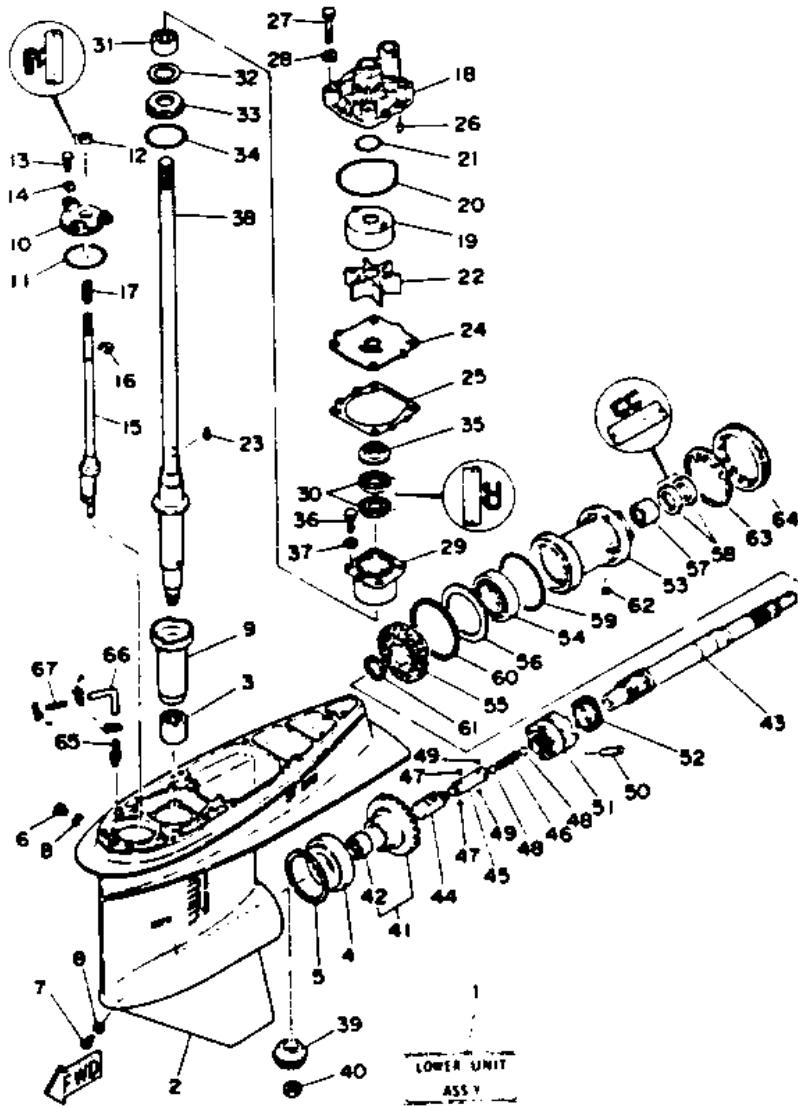

©2014 Yamaha Motor Corporation, U.S.A. All rights reserved.



## Part List







115TXRQ 1992 / LOWER DRIVE 1

REF - NO	PART NUMBER	PART NAME	QUANTITY	REMARKS
1	61U-45300-20-EK	LOWER UNIT ASSY (REF. 2~67) (6E5-45300-22-EK)	1	UR ULTRA LONG
1	61U-45300-10-EK	LOWER UNIT ASSY (REF. 2~67) (6E5-45300-13-EK)	1	UR LONG
2	6E5-45301-02-EK	LOWER CASING	1	
3	93315-628U9-00	BEARING	1	
4	93332-000U7-00	BEARING	1	
5	6E5-45567-01-30	SHIM (T:0.30MM)	1	UR
5	6E5-45567-01-12	SHIM (T:0.12MM)	1	UR
5	6E5-45567-01-50	SHIM (T:0.50MM)	1	UR
5	6E5-45567-01-40	SHIM (T:0.40MM)	1	UR
5	6E5-45567-01-18	SHIM (T:0.18MM)	1	UR
5	6E5-45567-01-10	SHIM (T:0.10MM)	1	UR
5	6E5-45567-01-15	SHIM (T:0.15MM)	1	UR
6	90340-08M04-00	PLUG, STRAIGHT SCREW	1	
7	688-45341-00-00	PLUG, DRAIN	1	
8	90430-08020-00	.GASKET	2	
9	6E5-45536-00-00	SLEEVE, DRIVE SHAFT	1	
10	6E5-45321-00-00	PLATE	1	
11	93210-58677-00	O-RING	1	
12	93106-09014-00	.OIL SEAL	1	
13	97395-06020-00	BOLT, HEXAGON	3	
14	90209-06M04-00	WASHER	3	
15	6E5-44150-01-00	SHIFT CAM ASSEMBLY	1	
16	99001-08600-00	CIRCLIP	1	
17	90501-11M10-00	SPRING, COMPRESSION	1	
18	6E5-44311-00-00	HOUSING, WATER PUMP	1	
19	6E5-44322-00-00	INSERT, CARTRIDGE	1	
20	93210-86M38-00	.O-RING	1	
21	93210-37M67-00	O-RING	1	
22	6E5-44352-00-00	IMPELLER	1	
23	90280-04M05-00	.KEY, WOODRUFF	1	
24	6E5-44323-00-00	OUTER PLATE, CARTRIDGE	1	
25	6E5-44315-A0-00	.GASKET, WATER PUMP	1	
26	93606-12019-00	.PIN, DOWEL	2	
27	97395-08045-00	BOLT	4	
28	90209-08M02-00	WASHER	4	
29	6E5-45331-00-94	HOUSING, BEARING	1	
30	93101-28M16-00	.OIL SEAL	2	
31	93317-330U2-00	BEARING	1	
32	6E5-45587-01-12	SHIM (T:0.12MM)	1	UR
32	6E5-45587-01-30	SHIM (T:0.30MM)	1	UR
32	6E5-45587-01-50	SHIM (T:0.50MM)	1	UR
32	6E5-45587-01-10	SHIM (T:0.10MM)	1	UR
32	6E5-45587-01-15	SHIM (T:0.15MM)	1	UR
32	6E5-45587-01-18	SHIM (T:0.18MM)	1	UR
32	6E5-45587-01-40	SHIM (T:0.40MM)	1	UR
33	93341-930U0-00	BEARING, THRUST	1	
34	93210-54534-00	O-RING	1	
35	6E5-45344-00-00	COVER, OIL SEAL	1	
36	97395-08025-00	BOLT	4	
37	92990-08600-00	..WASHER, PLATE	4	
38	6E5-45501-01-00	DRIVE SHAFT COMP.	1	UR LONG
38	6E5-45501-20-00	DRIVE SHAFT COMP	1	UR ULTRA LONG

39	6E5-45551-02-00	PINION (13T)	1	
40	90170-16M01-00	NUT	1	
41	6E5-45560-01-00	GEAR 1 (26T)	1	
42	93315-425U7-00	.BEARING	1	
43	6E5-45611-01-00	SHAFT, PROPELLER	1	
44	6E5-45641-01-00	SHIFTER	1	
45	6E5-45634-01-00	SLIDE, SHIFT	1	
46	90501-16M37-00	SPRING, COMPRESSION	1	
47	93507-32031-00	BALL 7-32	2	
48	93511-32027-00	BALL	2	
49	93503-16010-00	BALL 3-16	2	
50	90250-08M07-00	PIN, STRAIGHT	1	
51	6E5-45631-01-00	CLUTCH, DOG	1	
52	6E5-45633-01-00	RING, CROSS PIN	1	
53	6E5-45332-00-94	HOUSING, BEARING	1	
54	93306-208U0-00	BEARING	1	
55	6E5-45571-01-00	GEAR 2 (26T)	1	
56	6E5-45576-00-00	WASHER, THRUST 2	1	
57	93315-430U8-00	BEARING	1	
58	93101-30M17-00	.OIL SEAL	2	
59	93210-86M39-00	.O-RING	1	
60	6L6-45577-00-12	SHIM (T:0.12MM)	1	UR
60	6L6-45577-00-30	SHIM (T:0.30MM)	1	UR
60	6L6-45577-00-50	SHIM (T:0.50MM)	1	UR
60	6L6-45577-00-10	SHIM (T:0.10MM)	1	UR
60	6L6-45577-00-15	SHIM (T:0.15MM)	1	UR
60	6L6-45577-00-18	SHIM (T:0.18MM)	1	UR
60	6L6-45577-00-40	SHIM (T:0.40MM)	1	UR
61	90201-30M92-00	WASHER, PLATE	1	
62	90282-04010-00	KEY, STRAIGHT	1	
63	688-45383-02-00	WASHER, CLAW	1	
64	688-45384-00-00	NUT	1	
65	6E5-45378-00-00	NIPPLE, HOSE	1	
66	90445-07ME9-00	HOSE (L120)	1	UR
66	90445-07ME8-00	HOSE (L80)	1	UR
67	6E5-83558-10-00	END, NIPPLE	1	

## Part Notes

115TXRQ 1992 / LOWER DRIVE 1

PART NUMBER		NOTE TEXT
90430-08020-00		OEM: This part number is among the Top 100 Most Popular Marine Maintenance Parts as of March 2014.
93106-09014-00		OEM: This part number is among the Top 100 Most Popular Marine Maintenance Parts as of March 2014.
93210-86M38-00		OEM: This part number is among the Top 100 Most Popular Marine Maintenance Parts as of March 2014.
93101-28M16-00		OEM: This part number is among the Top 100 Most Popular Marine Maintenance Parts as of March 2014.
93210-54534-00		OEM: This part number is among the Top 100 Most Popular Marine Maintenance Parts as of March 2014.
93101-30M17-00		OEM: This part number is among the Top 100 Most Popular Marine Maintenance Parts as of March 2014.

©2014 Yamaha Motor Corporation, U.S.A. All rights reserved.

115TXRQ 1992 / LOWER DRIVE 2

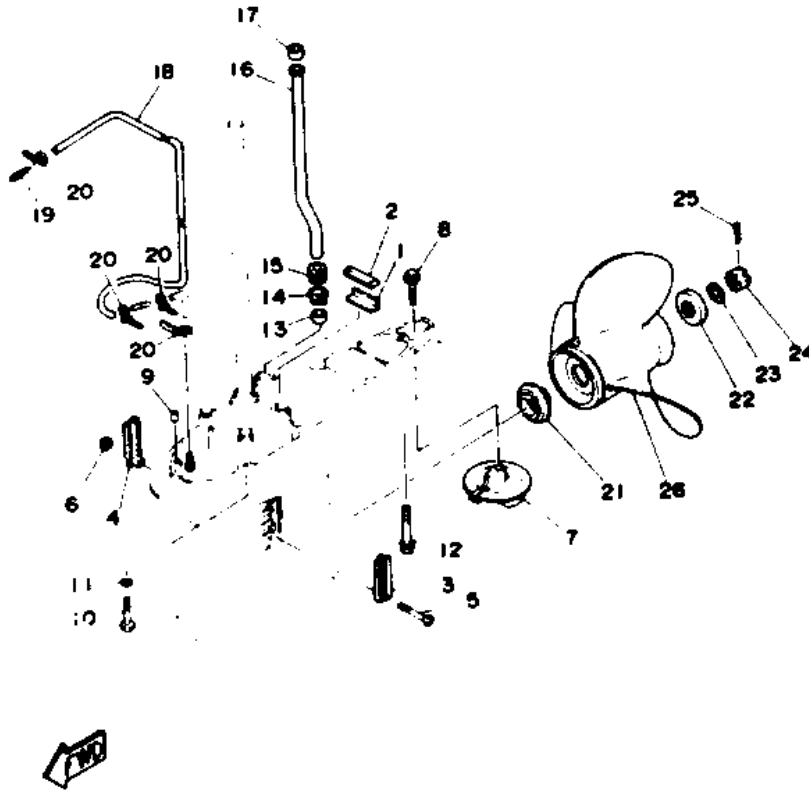

©2014 Yamaha Motor Corporation, U.S.A. All rights reserved.



## Part List



115TXRQ 1992 / LOWER DRIVE 2

REF - NO	PART NUMBER	PART NAME	QUANTITY	REMARKS
1	663-45376-00-94	GUIDE, SEAL DAMPER	1	See Note
2	688-45375-00-00	DAMPER, SEAL	1	See Note
3	688-45214-02-00	COVER, WATER INLET 1	1	
4	688-45215-02-00	COVER, WATER INLET 2	1	
5	90142-05M03-00	SCREW, COUNTERSUNK	1	
6	90185-05002-00	NUT, NYLON	1	
7	6E5-45371-01-00	TAB-TRIM	1	
8	90105-10M00-00	BOLT, FLANGE	1	
9	93608-12M05-00	PIN, DOWEL	2	
10	97395-10045-00	BOLT	6	
11	92990-10100-00	WASHER, SPRING	6	
12	90119-10M89-00	BOLT, WITH WASHER	1	
13	6E5-44365-00-00	DAMPER, WATER SEAL 1	1	See Note
14	6E5-44312-00-00	COVER, WATER PUMP HOUSING	1	See Note
15	6E5-44366-00-00	DAMPER, WATER SEAL 2	1	
16	6E5-44361-20-00	TUBE, WATER 1	1	UR ULTRA LONG
16	6E5-44361-00-00	TUBE, WATER 1	1	LONG
17	6E5-44365-00-00	DAMPER, WATER SEAL 1	1	
18	90445-07MF0-00	HOSE (L1030)	1	
19	6E5-83558-00-00	END, NIPPLE	1	
20	90465-11M10-00	CLAMP	4	
21	6E5-45987-00-00	SPACER 1	1	
22	688-45997-01-00	SPACER 2	1	
23	92990-18200-00	WASHER	1	
24	90171-18M04-00	NUT, CASTLE	1	
25	91490-40030-00	PIN. COTTER	1	
26	688-45974-02-98	PROPELLER (3X13"X23"-K)	1	UR STAINLESS STEEL PROPELLER
26	688-45978-60-98	PROPELLER (3X13-1/2"X16"-K)	1	UR STAINLESS STEEL PROPELLER
26	688-45930-01-98	PROPELLER (3X13"X17"-K)	1	UR STAINLESS STEEL PROPELLER
26	688-45932-60-98	PROPELLER (3X13-1/2"X14"-K)	1	UR STAINLESS STEEL PROPELLER
26	6E5-45952-00-EL	PROPELLER (3X13"X23"-K)	1	UR
26	6E5-45954-00-EL	PROPELLER (3X14"X11"-K)	1	UR
26	688-45976-01-98	PROPELLER (3X13"X25"-K)	1	UR STAINLESS STEEL PROPELLER
26	688-45972-02-98	PROPELLER (3X13"X21"-K)	1	UR STAINLESS STEEL PROPELLER
26	688-45970-03-98	PROPELLER (3 X 13-1/2" X 19" -K) ( )	1	UR STAINLESS STEEL PROPELLER
26	6E5-45949-00-EL	PROPELLER (3X13-5/8"X13"-K)	1	UR
26	6E5-45947-00-EL	PROPELLER (3X13-1/2"X15"-K)	1	UR
26	6E5-45941-00-EL	PROPELLER (3X13"X19"-K)	1	UR
26	6E5-45943-00-EL	PROPELLER (3X12-5/8"X21"-K)	1	UR
26	6E5-45945-01-EL	PROPELLER (3X13-1/4"X17"-K)	1	UR

## Part Notes

115TXRQ 1992 / LOWER DRIVE 2

PART NUMBER	NOTE TEXT
6E5-45371-01-00 	OEM: This part number is among the Top 100 Most Popular Marine Maintenance Parts as of March 2014.
90105-10M00-00 	OEM: This part number is among the Top 100 Most Popular Marine Maintenance Parts as of March 2014.

688-45997-01-00		OEM: This part number is among the Top 100 Most Popular Marine Maintenance Parts as of March 2014.
91490-40030-00		OEM: This part number is among the Top 100 Most Popular Marine Maintenance Parts as of March 2014.

©2014 Yamaha Motor Corporation, U.S.A. All rights reserved.

115TXRQ 1992 / CDI MAGNETO

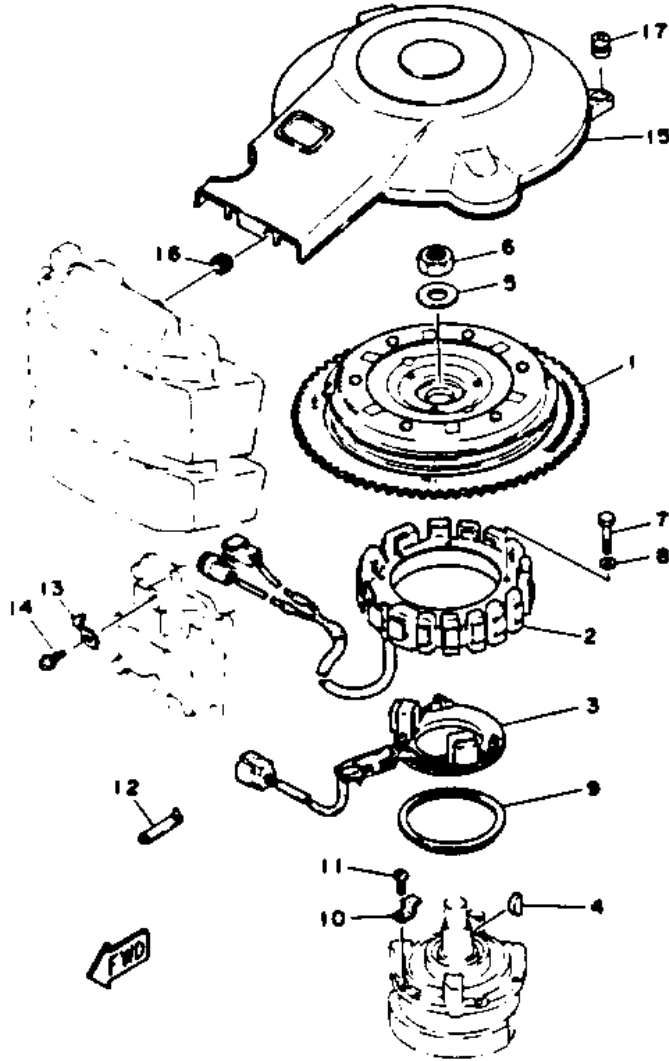

©2014 Yamaha Motor Corporation, U.S.A. All rights reserved.

## Part List

115TXRQ 1992 / CDI MAGNETO

REF - NO	PART NUMBER	PART NAME	QUANTITY	REMARKS
1	6N7-85550-00-00	ROTOR ASSY	1	
2	6N7-85510-00-00	STATOR ASSY	1	
3	6N7-85580-00-00	COIL, PULSER	1	
4	90280-05049-00	KEY, WOODRUFF	1	
5	90201-21M18-00	WASHER, PLATE	1	
6	90170-20137-00	NUT	1	
7	97313-06065-00	BOLT, HEXAGON	4	
8	92990-06600-00	WASHER, PLATE	4	
9	688-41611-00-00	RETAINER, MAGNETO BASE	1	
10	688-41612-00-00	RETAINER, MAGNETO BASE	4	
11	98503-06018-00	SCREW, PAN HEAD (92503-060180-00)	4	
12	90464-12M00-00	CLAMP	1	
13	6E5-81332-00-00	PLATE, TIMING	1	
14	97985-06210-00	SCREW, WITH WASHER	1	
15	6N7-81337-00-00	COVER, FLYWHEEL	1	
16	90480-12M11-00	GROMMET	2	
17	663-82317-00-00	DAMPER, IGNITION COIL	2	

## Part Notes

115TXRQ 1992 / CDI MAGNETO

PART NUMBER	NOTE TEXT
92990-06600-00 	OEM: This part number is among the Top 100 Most Popular Marine Maintenance Parts as of March 2014.

©2014 Yamaha Motor Corporation, U.S.A. All rights reserved.

115TXRQ 1992 / ELECTRIC MOTOR

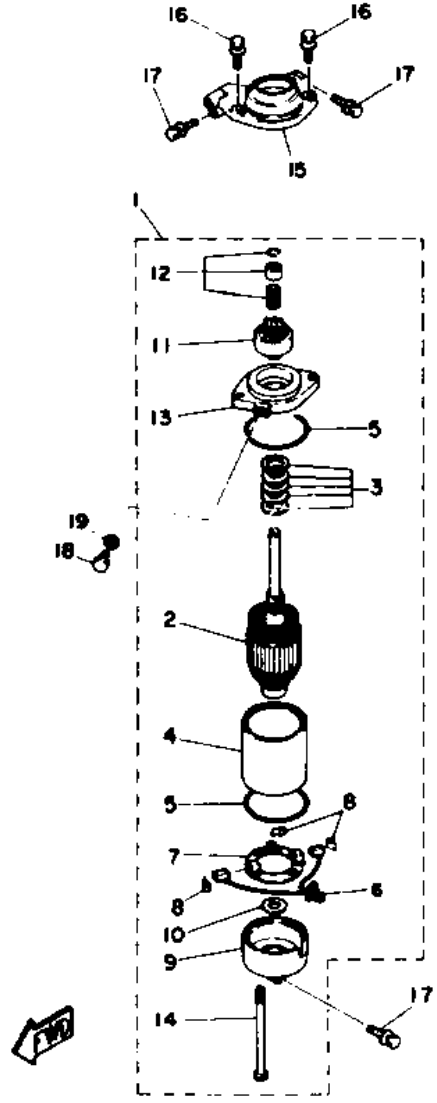

©2014 Yamaha Motor Corporation, U.S.A. All rights reserved.



## Part List

115TXRQ 1992 / ELECTRIC MOTOR

REF - NO	PART NUMBER	PART NAME	QUANTITY	REMARKS
1	6E5-81800-12-00	STARTER MOTOR ASSY	1	
2	6E5-81850-11-00	.ARMATURE ASSY	1	
3	6E5-81809-10-00	.WASHER KIT	1	
4	6E5-81810-10-00	.STATOR ASSY	1	
5	6E5-81847-10-00	.O-RING	2	
6	6E5-81801-10-00	.BRUSH SET	1	
7	6E5-81840-10-00	.BRUSH HOLDER ASSY	1	
8	6E5-81813-10-00	.SPRING, BRUSH	3	
9	6E5-81820-11-00	.REAR BRACKET ASSY	1	
10	6E5-81824-00-00	.WASHER 2	1	
11	6E5-81807-11-00	.GEAR ASSY, STARTING MOTOR	1	
12	61H-81857-00-00	.RETAINER	1	
13	6E5-81830-10-00	.FRONT BRACKET ASSY	1	
14	6E5-81826-10-00	.BOLT	2	
15	6R3-81822-00-94	BRACKET, STARTING MOTOR	1	
16	90119-08M76-00	BOLT, WITH WASHER	2	
17	90119-08M77-00	BOLT, WITH WASHER	3	
18	97395-08016-00	BOLT	1	
19	92990-08600-00	..WASHER, PLATE	1	

115TXRQ 1992 / ELECTRIC PARTS 1

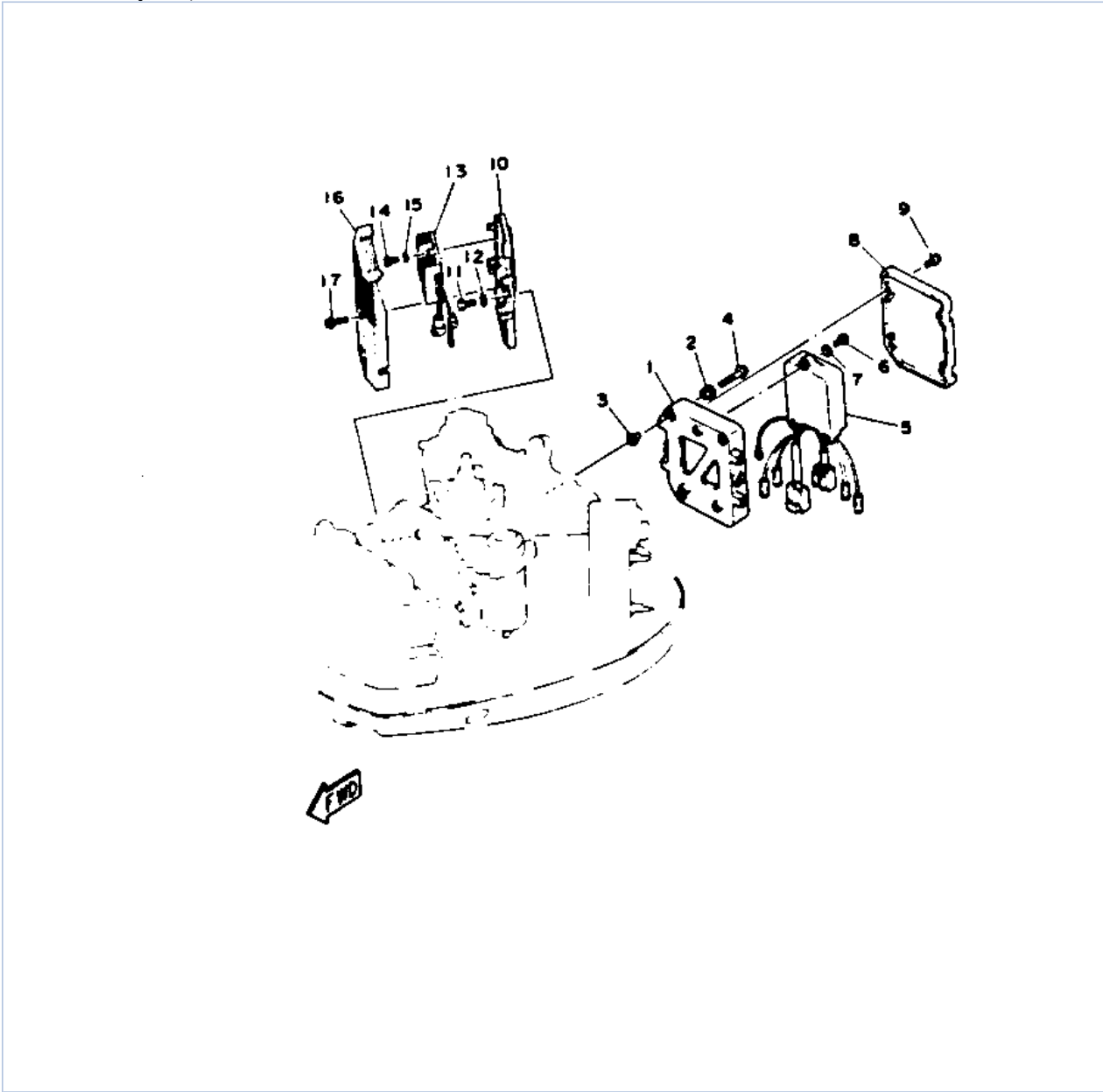

©2014 Yamaha Motor Corporation, U.S.A. All rights reserved.



## Part List

115TXRQ 1992 / ELECTRIC PARTS 1

REF - NO	PART NUMBER	PART NAME	QUANTITY	REMARKS
1	6N7-85542-00-EK	BRACKET	1	
2	6A0-82317-00-00	DAMPER, IGNITION COIL	3	
3	624-42542-00-00	PIPE	3	
4	90119-06M59-00	BOLT, WITH WASHER	3	
5	6N7-85540-00-00	C.D.I. UNIT ASSEMBLY	1	
6	98580-06020-00	SCREW, PAN HEAD	3	
7	92990-06600-00	WASHER, PLATE	3	
8	6N7-85537-00-00	COVER	1	
9	90159-06M11-00	SCREW, WITH WASHER	4	
10	6N7-81948-00-94	BRACKET	1	
11	97313-06016-00	BOLT, HEXAGON	3	
12	92990-06600-00	WASHER, PLATE	3	
13	6R3-81960-00-00	RECTIFIER & REGULATOR ASSY	1	
14	97313-06025-00	BOLT	2	
15	92990-06600-00	WASHER, PLATE	2	
16	6R3-81942-00-00	COVER	1	
17	90159-06M08-00	SCREW, WITH WASHER	4	

## Part Notes

115TXRQ 1992 / ELECTRIC PARTS 1

PART NUMBER		NOTE TEXT
92990-06600-00		OEM: This part number is among the Top 100 Most Popular Marine Maintenance Parts as of March 2014.
92990-06600-00		OEM: This part number is among the Top 100 Most Popular Marine Maintenance Parts as of March 2014.
92990-06600-00		OEM: This part number is among the Top 100 Most Popular Marine Maintenance Parts as of March 2014.

©2014 Yamaha Motor Corporation, U.S.A. All rights reserved.

115TXRQ 1992 / ELECTRIC PARTS 2

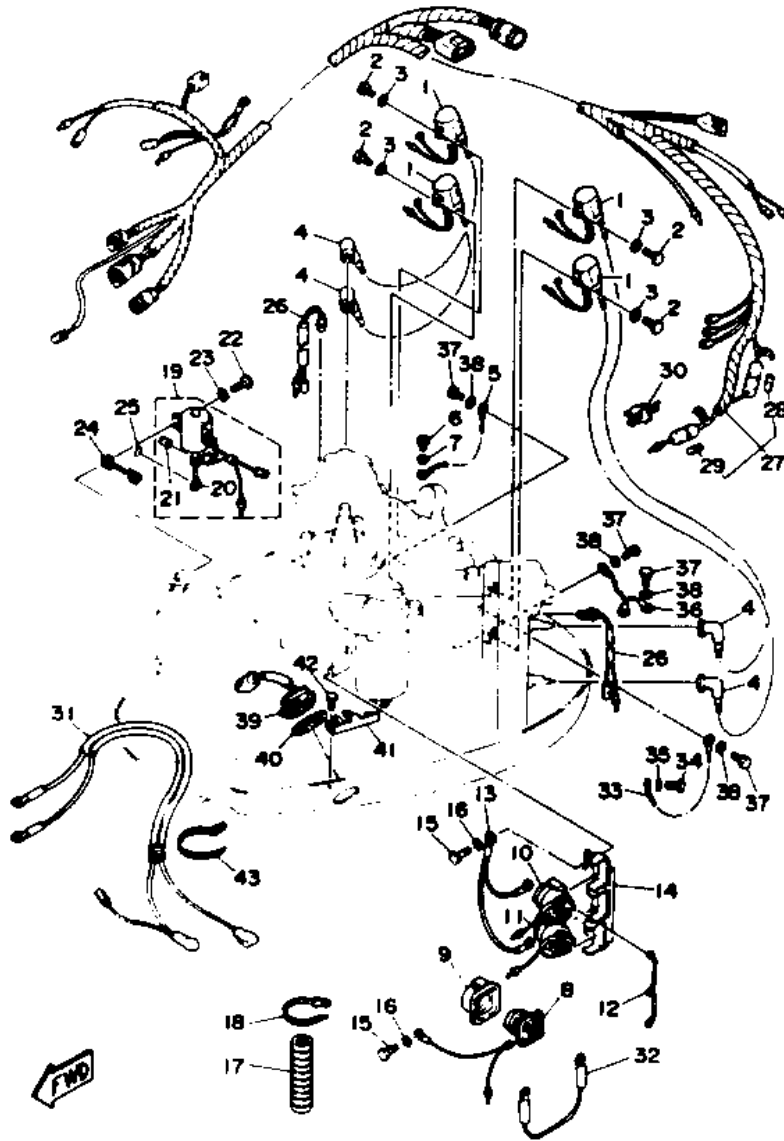

©2014 Yamaha Motor Corporation, U.S.A. All rights reserved.



## Part List



115TXRQ 1992 / ELECTRIC PARTS 2

REF - NO	PART NUMBER	PART NAME	QUANTITY	REMARKS
1	6R3-85570-00-00	IGNITION COIL ASSEMBLY	4	
2	97395-06020-00	BOLT, HEXAGON	4	
3	92990-06600-00	WASHER, PLATE	4	
4	663-82370-01-00	PLUG CAP ASSY	4	
5	662-82519-00-00	WIRE, EARTH LEAD	1	
6	97395-06012-00	BOLT	1	
7	92990-06600-00	WASHER, PLATE	1	
8	6E5-81941-11-00	STARTER RELAY ASSY	1	
9	689-81952-10-00	HOLDER, RELAY	1	
10	6E5-81950-00-00	RELAY ASSY	1	
11	6E5-8195A-00-00	RELAY ASSY	1	
12	6G5-87149-10-00	CONNECTOR	1	
13	6E5-82116-00-00	WIRE, MINUS LEAD	1	
14	6E5-81948-21-00	BRACKET	1	
15	97395-06016-00	BOLT, HEX	2	
16	92990-06600-00	WASHER, PLATE	2	
17	6N7-83557-00-00	TUBE (I.DIA:22MM)	1	
18	90465-13M36-00	CLAMP	1	
19	6N7-86110-00-00	SOLENOID	1	
20	6N7-86116-00-00	.WIRE, PULL	1	
21	91609-30010-00	.PIN, SPRING	1	
22	97395-06030-00	BOLT	2	
23	92990-06600-00	WASHER, PLATE	2	
24	6N7-86112-00-00	STAY, SOLENOID	1	
25	93210-03261-00	O-RING	1	
26	688-82560-10-00	THERMO SWITCH ASSY	2	
27	6N7-82590-12-00	WIRE HARNESS ASSEMBLY	1	
28	682-82151-00-00	.FUSE (12V-20A)	1	
29	705-82151-00-00	.FUSE (30A)	1	
30	6G5-82152-00-00	HOLDER, FUSE	2	
31	6N7-82105-00-00	BATTERY CABLE	1	
32	6E5-82117-00-00	WIRE, LEAD	1	
33	6R3-82519-00-00	WIRE, EARTH LEAD	1	
34	97395-06012-00	BOLT	1	
35	92990-06600-00	WASHER, PLATE	1	
36	6E5-82531-00-00	WIRE, LEAD	1	
37	97395-06012-00	BOLT	4	
38	92990-06600-00	WASHER, PLATE	4	
39	6R3-82563-00-00	TRIM & TILT SWITCH ASSY	1	
40	6E5-82587-00-00	GASKET	1	
41	6R3-83614-00-00	BRACKET	1	
42	97395-06016-00	BOLT, HEX	2	
43	90465-13M36-00	CLAMP	1	

## Part Notes

115TXRQ 1992 / ELECTRIC PARTS 2

PART NUMBER		NOTE TEXT
92990-06600-00		OEM: This part number is among the Top 100 Most Popular Marine Maintenance Parts as of March 2014.
92990-06600-00		OEM: This part number is among the Top 100 Most Popular Marine Maintenance Parts as of March 2014.
92990-06600-00		OEM: This part number is among the Top 100 Most Popular Marine Maintenance Parts as of March 2014.
92990-06600-00		OEM: This part number is among the Top 100 Most Popular Marine Maintenance Parts as of March 2014.

		
92990-06600-00		OEM: This part number is among the Top 100 Most Popular Marine Maintenance Parts as of March 2014.
92990-06600-00		OEM: This part number is among the Top 100 Most Popular Marine Maintenance Parts as of March 2014.

©2014 Yamaha Motor Corporation, U.S.A. All rights reserved.

115TXRQ 1992 / OIL PUMP

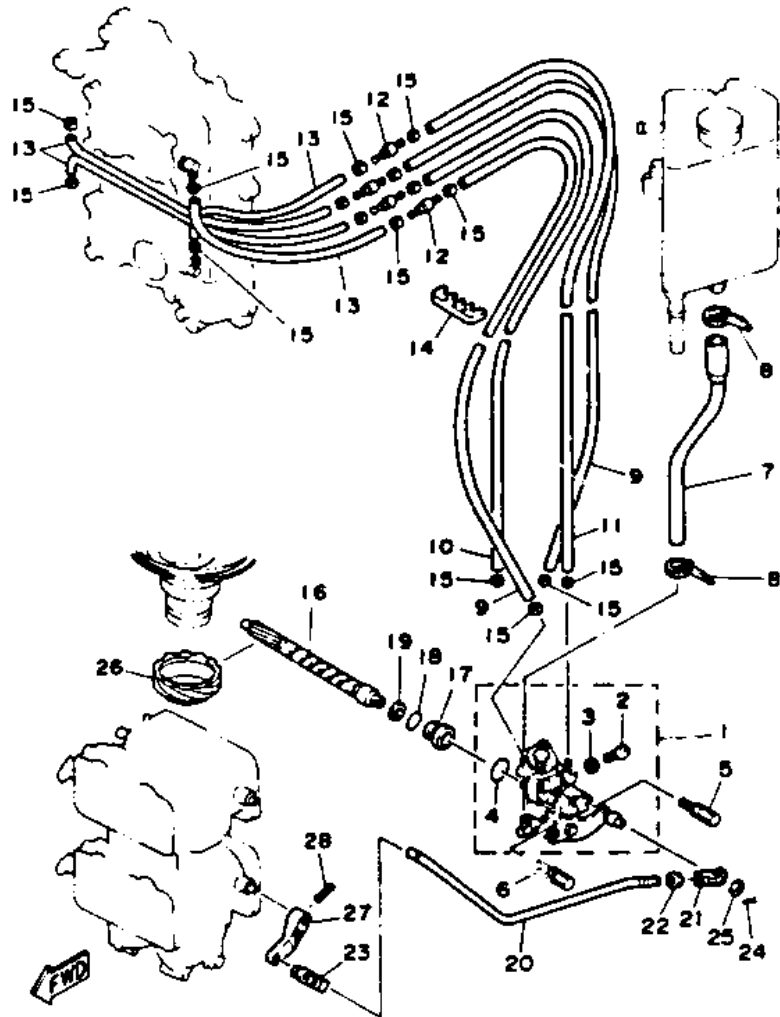

©2014 Yamaha Motor Corporation, U.S.A. All rights reserved.

## Part List

115TXRQ 1992 / OIL PUMP

REF - NO	PART NUMBER	PART NAME	QUANTITY	REMARKS
1	6N7-13200-00-00	OIL INJECTION PUMP ASSY	1	UR 130 MODEL
1	6N6-13200-00-00	OIL INJECTION PUMP ASSY	1	UR 115 MODEL
2	716-24444-00-00	.PLUG, DRAIN	1	
3	6L2-13475-00-00	.GASKET	1	
4	93210-19MA7-00	.O-RING	1	
5	90109-06M40-00	BOLT	1	
6	90109-06M39-00	BOLT	1	
7	6N7-13416-00-00	PIPE, OIL 1	1	
8	90465-11M10-00	CLAMP	2	
9	90445-07M85-00	HOSE (L330)	2	
10	90445-07M84-00	HOSE	1	
11	90445-07M73-00	HOSE	1	
12	6R3-13183-00-00	VALVE, CHECK	4	
13	90445-07M87-00	HOSE (L110)	4	
14	90464-07M06-00	CLAMP	1	
15	90468-07M02-00	CLIP	16	
16	6R3-11537-00-00	GEAR, DRIVEN	1	
17	6R3-13117-00-00	COLLAR, DISTANCE	1	
18	93210-13595-00	O-RING	1	
19	90202-08M44-00	WASHER, PLATE	1	
20	6R3-41241-00-00	ROD, LINK	1	
21	6H1-41237-00-00	JOINT, LINK	1	
22	95380-05600-00	NUT	1	
23	6R5-41237-00-00	JOINT, LINK	1	
24	90468-05M03-00	CLIP	1	
25	90202-05088-00	WASHER, PLATE	1	
26	6R3-11536-00-00	GEAR, DRIVE	1	
27	6E5-14276-01-00	LEVER	1	
28	91690-30016-00	PIN, SPRING	1	

## Part Notes

115TXRQ 1992 / OIL PUMP

PART NUMBER	NOTE TEXT
6H1-41237-00-00 	OEM: This part number is among the Top 100 Most Popular Marine Maintenance Parts as of March 2014.

©2014 Yamaha Motor Corporation, U.S.A. All rights reserved.



115TXRQ 1992 / OIL TANK

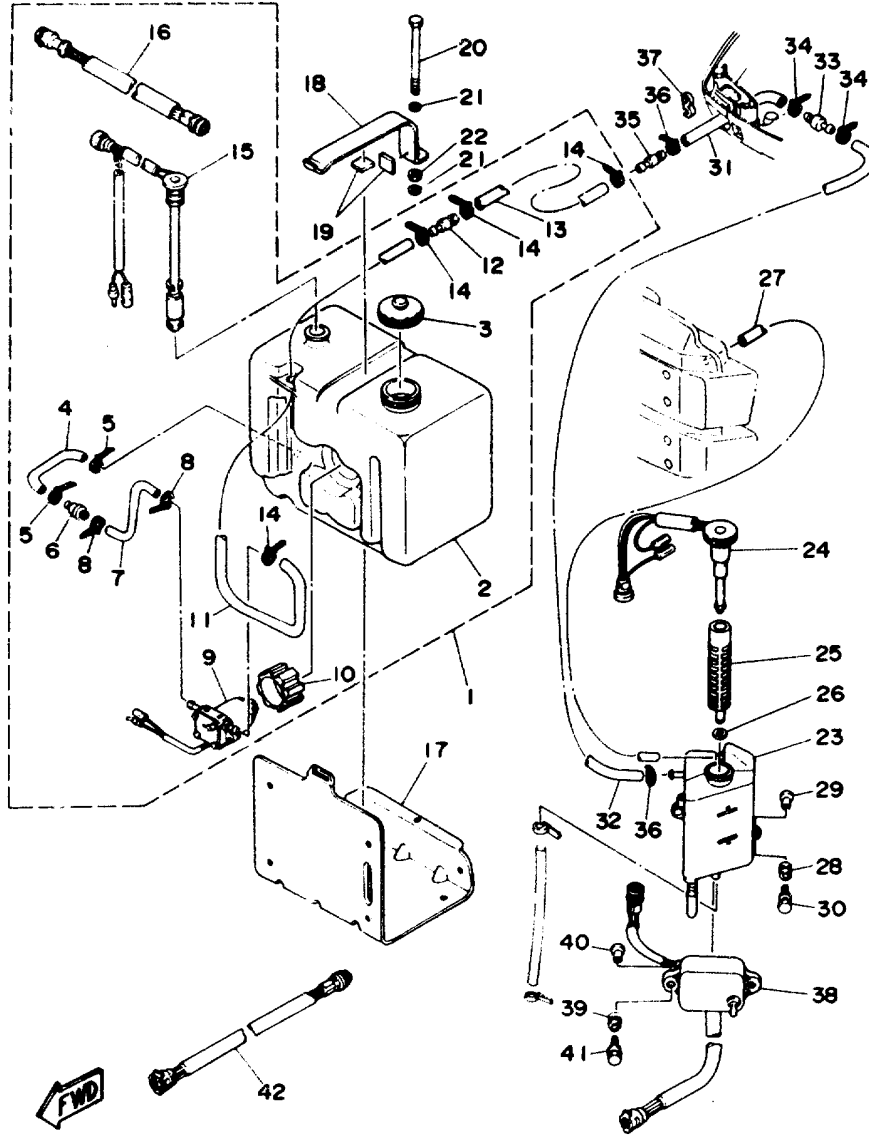

©2014 Yamaha Motor Corporation, U.S.A. All rights reserved.

## Part List



115TXRQ 1992 / OIL TANK

REF - NO	PART NUMBER	PART NAME	QUANTITY	REMARKS
1	6E5-21708-05-00	OIL TANK SUB-ASSY	1	
2	6E5-21733-02-00	.SUB TANK, OIL (105L)	1	
3	6E5-21770-03-00	.OIL TANK CAP ASSY	1	
4	6E5-24322-00-00	.PIPE 11	1	
5	90465-11M10-00	.CLAMP	2	
6	646-24251-02-00	.STRAINER 1	1	
7	6E5-24319-01-00	.PIPE, OIL	1	
8	90465-11M10-00	.CLAMP	2	
9	6E5-81900-01-00	.OIL FEED PUMP ASSY	1	
10	6E5-81922-00-00	.GROMMET	1	
11	6E5-24321-01-00	.PIPE 10	1	
12	6E5-24379-00-00	.PIPE, JOINT 4	1	
13	90445-11M81-00	.HOSE (L3000)	1	
14	90465-11M10-00	.CLAMP	4	
15	6E5-85720-02-00	.OIL LEVEL GAUGE ASSY	1	
16	6N7-85721-00-00	WIRE, LEAD	1	
16	6E5-85721-10-00	.WIRE LEAD	1	
17	6E5-21734-01-33	HOLDER, OIL SUB TANK	1	
18	6E5-21798-01-33	BRACKET, DAMPER	1	
19	6E5-21746-00-00	DAMPER	2	
20	97380-06100-00	BOLT, HEXAGON (91201-06100)	1	
21	92990-06600-00	WASHER, PLATE	2	
22	95380-06600-00	NUT, HEXAGON	1	
23	6E5-21750-04-00	OIL TANK ASSY (6E5-21750-03-00)	1	
24	6G7-85730-03-00	OIL LEVEL GAUGE ASSY	1	
25	6E5-13411-00-00	STRAINER, OIL	1	
26	6E5-13414-00-00	GASKET, STRAINER COVER	1	
27	90445-05M02-00	HOSE (L380)	1	
28	6A0-82317-00-00	DAMPER, IGNITION COIL	3	
29	624-42542-00-00	PIPE	3	
30	90119-06M65-00	BOLT, WITH WASHER	3	
31	6R3-24323-10-00	PIPE 12	1	
32	90445-12M02-00	HOSE (LONG)	1	
32	90445-12M05-00	HOSE	1	
33	6E5-24379-00-00	PIPE, JOINT 4	1	
34	90465-11M10-00	CLAMP	2	
35	6E5-24379-00-00	PIPE, JOINT 4	1	
36	90465-11M10-00	CLAMP	2	
37	90464-13M34-00	CLAMP	1	
38	6E5-85740-02-00	CONTROL UNIT ASSY	1	
39	6A0-82317-00-00	DAMPER, IGNITION COIL	2	
40	624-42542-00-00	PIPE	2	
41	90119-06M65-00	BOLT, WITH WASHER	2	
42	6E5-82521-03-00	WIRE, LEAD	1	
42	6N7-82521-00-00	WIRE, LEAD	1	

## Part Notes

115TXRQ 1992 / OIL TANK

PART NUMBER	NOTE TEXT
646-24251-02-00 	OEM: This part number is among the Top 100 Most Popular Marine Maintenance Parts as of March 2014.
6E5-81900-01-00	OEM: This part number is among the Top 100 Most Popular Marine Maintenance Parts as of March 2014.

		
92990-06600-00		OEM: This part number is among the Top 100 Most Popular Marine Maintenance Parts as of March 2014.

©2014 Yamaha Motor Corporation, U.S.A. All rights reserved.

115TXRQ 1992 / STEERING GUIDE ATTACHMENT

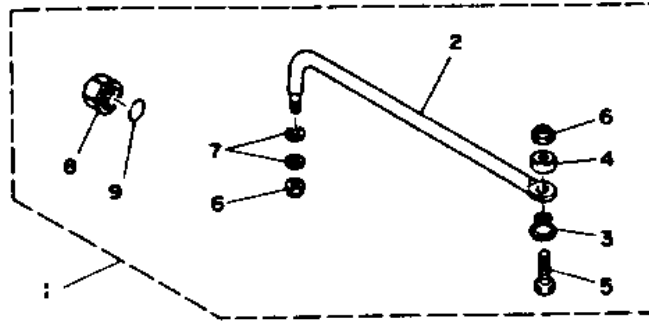

©2014 Yamaha Motor Corporation, U.S.A. All rights reserved.

## Part List

115TXRQ 1992 / STEERING GUIDE ATTACHMENT

REF - NO	PART NUMBER	PART NAME	QUANTITY	REMARKS
1	6E5-61350-01-00	STEERING GUIDE ATTACHMENT KIT	1	
2	6E5-61351-00-00	.ROD, STEERING LINK	1	
3	90387-10M61-00	..COLLAR	1	
4	90560-12M01-00	..SPACER	1	
5	6E5-61355-00-00	.BOLT	1	
6	90185-09M01-00	.NUT, SELF-LOCKING	2	
7	90201-10M20-00	.WASHER, PLATE	2	
8	6E5-43145-00-00	.CAP, CLAMP BRACKET	1	
9	93210-16716-00	.O-RING	1	

115TXRQ 1992 / REPAIR KIT 1

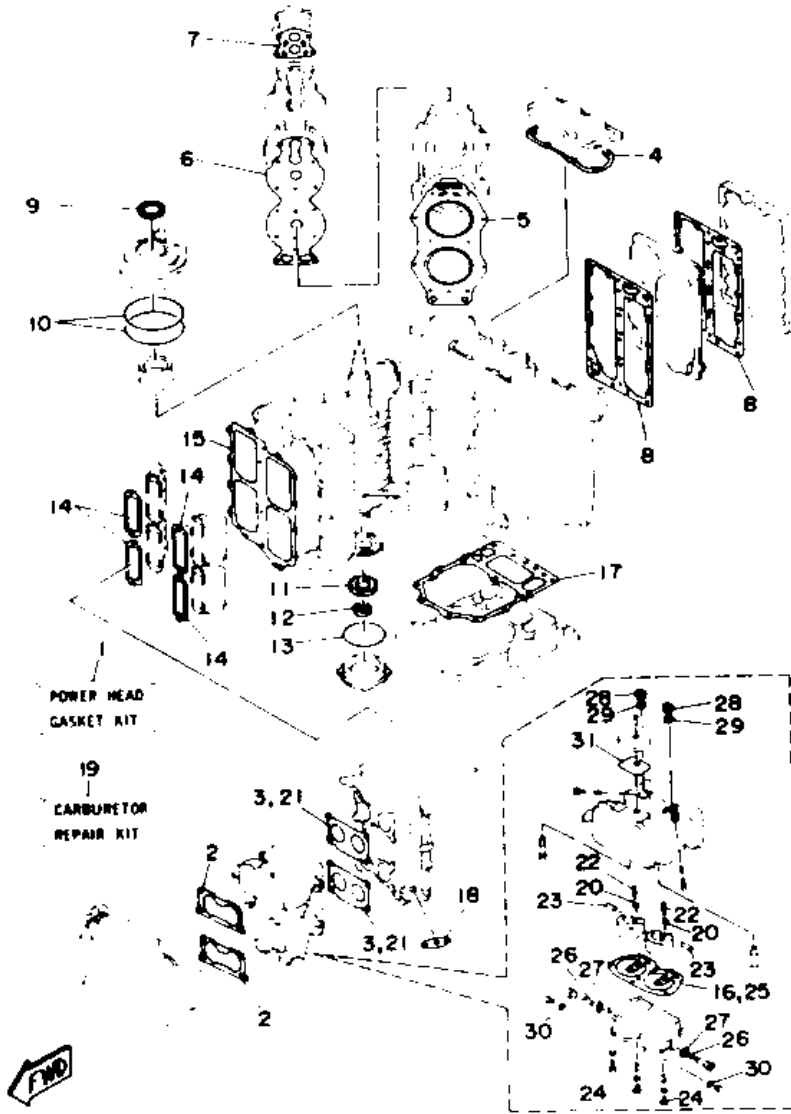

©2014 Yamaha Motor Corporation, U.S.A. All rights reserved.



## Part List

115TXRQ 1992 / REPAIR KIT 1

REF - NO	PART NUMBER	PART NAME	QUANTITY	REMARKS
1	6N6-W0001-03-00	POWER HEAD GASKET KIT	1	
2	6K7-14483-00-00	.GASKET	2	
3	6E5-14198-A1-00	.GASKET	2	
4	6E5-11381-A1-00	.GASKET 1	1	
5	6E5-11181-A0-00	.GASKET, CYLINDER HEAD 1	2	
6	6E5-11193-A0-00	.GASKET, HEAD COVER 1	2	
7	688-12414-A1-00	.GASKET, COVER	2	
8	6E5-41112-A0-00	.GASKET, EXHAUST INNER COVER	2	
9	93102-40M38-00	.OIL SEAL	1	
10	93211-04384-00	.O-RING	2	
11	93102-35M13-00	.OIL SEAL	1	
12	93101-22M15-00	.OIL SEAL	1	
13	93210-74M35-00	.O-RING	1	
14	6E5-13621-A1-00	.GASKET, VALVE SEAT	4	
15	6E5-13645-A1-00	.GASKET, MANIFOLD 1	1	
16	6E5-14384-03-00	.GASKET, FLOAT CHAMBER	2	
17	6G5-45113-A0-00	.GASKET, UPPER CASING	1	
18	650-24431-A0-00	.GASKET, FUEL PUMP 1	1	
19	6E5-W0093-06-00	CARBURETOR REPAIR KIT	1	
20	6E5-14159-00-00	.CLIP	2	
21	6E5-14198-A1-00	.GASKET	1	
22	6E5-14546-00-00	.VALVE, NEEDLE	2	
23	6E5-14386-02-00	.PIN, FLOAT	2	
24	6E5-14394-00-00	.PLUG, SLOW JET	2	
25	6E5-14384-03-00	.GASKET, FLOAT CHAMBER	1	
26	6E5-14997-00-00	.O-RING	2	
27	6E5-14398-01-00	.GASKET	2	
28	6E5-14328-01-00	.PLUG	2	
29	6E5-14979-00-00	.GASKET	2	
30	6J8-14995-00-00	.GASKET	2	
31	6E5-14959-00-00	.GASKET	1	

## Part Notes

115TXRQ 1992 / REPAIR KIT 1

PART NUMBER	NOTE TEXT
688-12414-A1-00 	OEM: This part number is among the Top 100 Most Popular Marine Maintenance Parts as of March 2014.
93211-04384-00 	OEM: This part number is among the Top 100 Most Popular Marine Maintenance Parts as of March 2014.
650-24431-A0-00 	OEM: This part number is among the Top 100 Most Popular Marine Maintenance Parts as of March 2014.

©2014 Yamaha Motor Corporation, U.S.A. All rights reserved.

115TXRQ 1992 / REPAIR KIT 2

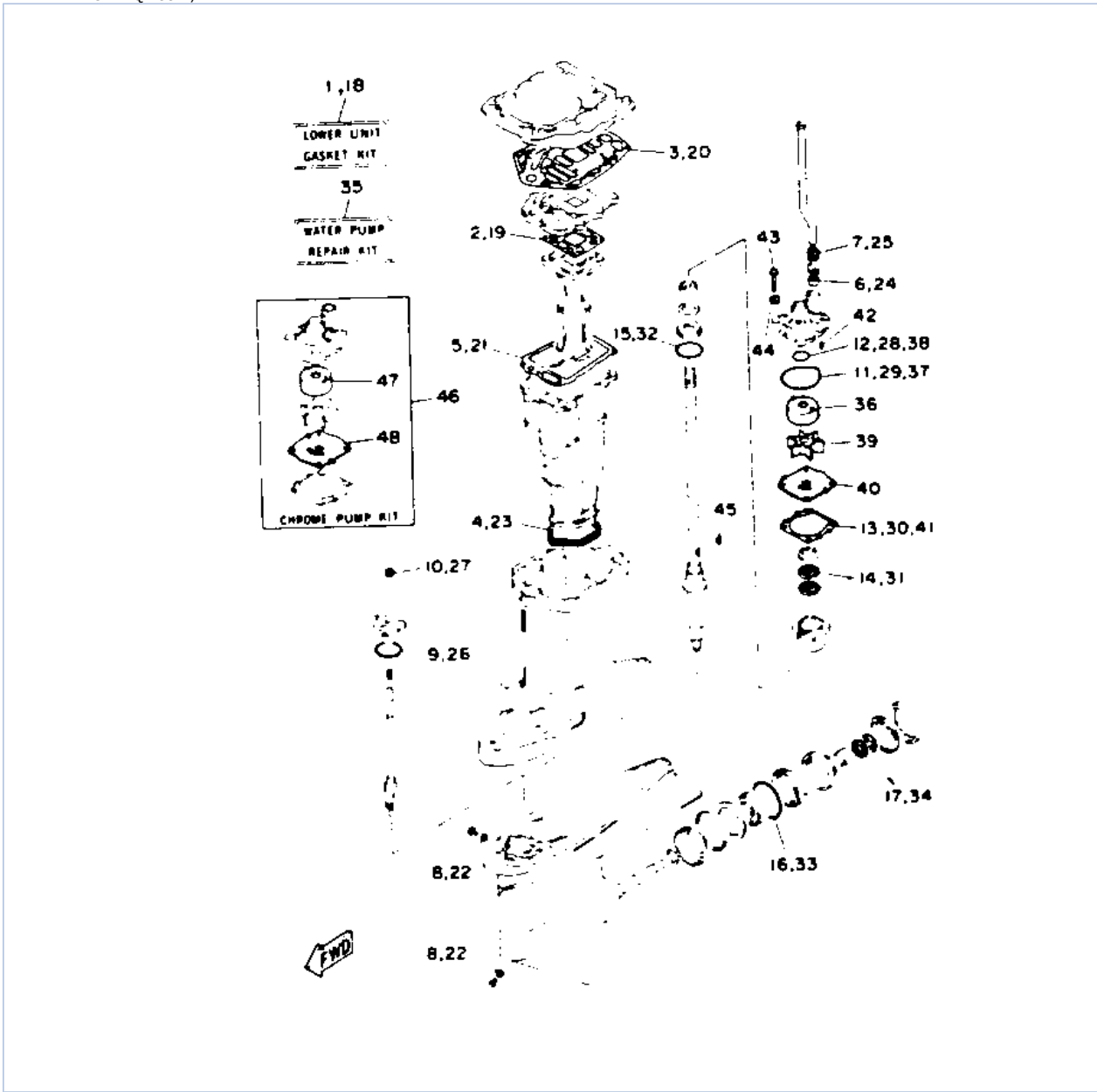

©2014 Yamaha Motor Corporation, U.S.A. All rights reserved.















## Part List

115TXRQ 1992 / REPAIR KIT 2

REF - NO	PART NUMBER	PART NAME	QUANTITY	REMARKS
1	6E5-W0001-51-00	LOWER UNIT GASKET KIT	1	MODEL
1	6E5-W0001-51-00	LOWER UNIT GASKET KIT	1	MODEL
2	6E5-41134-A0-00	.GASKET, EXHAUST MANIFOLD	1	
3	6G5-45114-A0-00	.GASKET, UPPER CASING	1	
4	6E5-45123-00-00	.GASKET, MUFFLER	1	
5	6E5-41135-A0-00	.GASKET, EXHAUST MANIFOLD	1	
6	6E5-44365-00-00	.DAMPER, WATER SEAL 1	1	
7	6E5-44366-00-00	.DAMPER, WATER SEAL 2	1	
8	90430-08020-00	.GASKET	2	
9	93210-58677-00	.O-RING	1	
10	93106-09014-00	.OIL SEAL	1	
11	93210-86M38-00	.O-RING	1	
12	93210-37M67-00	O-RING	1	
13	6E5-44315-00-00	GASKET, WATER PUMP	1	
14	93101-28M16-00	.OIL SEAL	2	
15	93210-54534-00	.O-RING	1	
16	93210-86M39-00	.O-RING	1	
17	93101-30M17-00	.OIL SEAL	2	
18	6F3-W0001-21-00	LOWER UNIT GASKET KIT	1	MODEL
18	6F3-W0001-21-00	LOWER UNIT GASKET KIT	1	MODEL
19	6G5-41134-A0-00	.GASKET, EXHAUST MANIFOLD	1	
20	6G5-45114-A0-00	.GASKET, UPPER CASING	1	
21	6E5-41135-A0-00	.GASKET, EXHAUST MANIFOLD	1	
22	90430-08020-00	.GASKET	2	
23	6E5-45123-00-00	.GASKET, MUFFLER	1	
24	6E5-44365-00-00	.DAMPER, WATER SEAL 1	1	
25	6E5-44366-00-00	.DAMPER, WATER SEAL 2	1	
26	93210-58677-00	.O-RING	1	
27	93106-09014-00	.OIL SEAL	1	
28	93210-37M67-00	O-RING	1	
29	93210-86M38-00	.O-RING	1	
30	6E5-44315-A0-00	.GASKET, WATER PUMP	1	
31	93101-28M16-00	.OIL SEAL	2	
32	93210-54534-00	.O-RING	1	
33	93210-86M39-00	.O-RING	1	
34	93101-30M17-00	.OIL SEAL	2	
35	6E5-W0078-01-00	WATER PUMP REPAIR KIT	1	
36	6E5-44322-00-00	INSERT, CARTRIDGE	1	
37	93210-86M38-00	.O-RING	1	
38	93210-37M67-00	O-RING	1	
39	6E5-44352-00-00	.IMPELLER	1	
40	6E5-44323-00-00	.OUTER PLATE, CARTRIDGE	1	
41	6E5-44315-A0-00	.GASKET, WATER PUMP	1	
42	93606-12019-00	.PIN, DOWEL	2	
43	97395-08045-00	.BOLT	4	
44	90209-08M02-00	WASHER	4	
45	90280-04M05-00	.KEY, WOODRUFF	1	
46	6E5-W0078-0A-00	CHROME PUMP KIT	1	
47	6E5-44322-41-00	INSERT, CARTRIDGE	1	
48	6E5-44323-40-00	.OUTER PLATE, CARTRIDGE	1	

## Part Notes

115TXRQ 1992 / REPAIR KIT 2

PART NUMBER		NOTE TEXT
90430-08020-00		OEM: This part number is among the Top 100 Most Popular Marine Maintenance Parts as of March 2014.
93106-09014-00		OEM: This part number is among the Top 100 Most Popular Marine Maintenance Parts as of March 2014.
93210-86M38-00		OEM: This part number is among the Top 100 Most Popular Marine Maintenance Parts as of March 2014.
93101-28M16-00		OEM: This part number is among the Top 100 Most Popular Marine Maintenance Parts as of March 2014.
93210-54534-00		OEM: This part number is among the Top 100 Most Popular Marine Maintenance Parts as of March 2014.
93101-30M17-00		OEM: This part number is among the Top 100 Most Popular Marine Maintenance Parts as of March 2014.
90430-08020-00		OEM: This part number is among the Top 100 Most Popular Marine Maintenance Parts as of March 2014.
93106-09014-00		OEM: This part number is among the Top 100 Most Popular Marine Maintenance Parts as of March 2014.
93210-86M38-00		OEM: This part number is among the Top 100 Most Popular Marine Maintenance Parts as of March 2014.
93101-28M16-00		OEM: This part number is among the Top 100 Most Popular Marine Maintenance Parts as of March 2014.
93210-54534-00		OEM: This part number is among the Top 100 Most Popular Marine Maintenance Parts as of March 2014.
93101-30M17-00		OEM: This part number is among the Top 100 Most Popular Marine Maintenance Parts as of March 2014.
93210-86M38-00		OEM: This part number is among the Top 100 Most Popular Marine Maintenance Parts as of March 2014.

©2014 Yamaha Motor Corporation, U.S.A. All rights reserved.

©2014 Yamaha Motor Corporation, U.S.A. All rights reserved.