

90ETLK 1985 / CRANKCASE CYLINDER

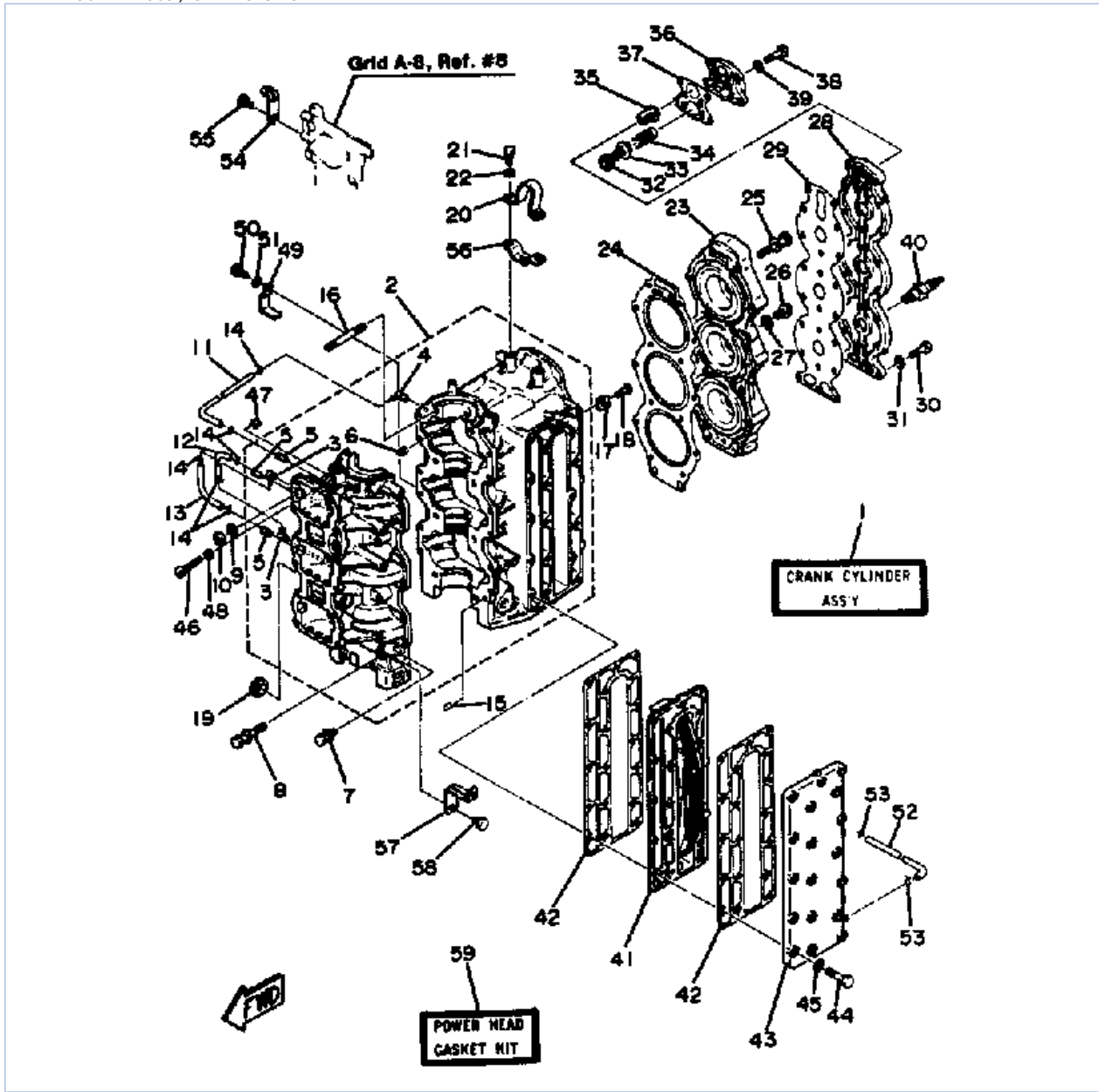

©2014 Yamaha Motor Corporation, U.S.A. All rights reserved.

Part List





90ETLK 1985 / CRANKCASE CYLINDER

REF - NO	PART NUMBER	PART NAME	QUANTITY	REMARKS
1	6H1-W0090-40-EK	CRANK-CYLINDER ASSEMBLY (REF. 2~58, & GRID A-4, REF.)	1	
2	6H1-15100-01-94	CRANKCASE ASSEMBLY	1	
3	688-11370-00-00	.CHECK VALVE ASSY	2	
4	650-11370-00-00	.CHECK VALVE ASSY	1	
5	624-14485-00-00	.PIPE, JOINT	3	
6	663-11518-01-00	.LOCK BEARING	3	
7	90119-06M12-00	BOLT, WITH WASHER	12	
8	90119-10M07-00	BOLT, WITH WASHER	6	
9	90201-100F7-00	WASHER, PLATE	2	
10	95313-10600-00	NUT	2	
11	90445-07260-00	HOSE (L276)	1	
12	90445-07M00-00	HOSE (L100)	1	
13	90445-07M23-00	HOSE (L408)	1	
14	90467-06016-00	CLIP	6	
15	93608-12063-00	PIN, DOWEL	2	
16	90116-10M06-00	BOLT, STUD	2	
17	688-11325-00-00	ANODE	2	
18	98680-04016-00	SCREW OVAL HEAD	2	
19	90480-24M04-00	GROMMET	1	
20	688-11119-00-00	HANGER, ENGINE	1	
21	97313-08020-00	BOLT, HEXAGON	2	
22	92990-08100-00	WASHER, SPRING	2	
23	6H1-11111-01-94	HEAD, CYLINDER 1	1	
24	688-11181-A0-00	GASKET, CYLINDER HEAD 1	1	
25	90119-08M21-00	BOLT, WITH WASHER	14	
26	90340-14M00-00	.PLUG, STRAIGHT SCREW	1	
27	90430-14115-00	.GASKET	1	
28	688-11191-00-9M	COVER, CYLINDER HEAD 1	1	
29	688-11193-A1-00	GASKET, HEAD COVER 1	1	
30	97313-06025-00	BOLT	18	
31	92990-06600-00	WASHER, PLATE	18	
32	90480-20M05-00	GROMMET	1	
33	688-12416-00-00	VALVE, PRESSURE CONTROL	1	
34	90501-16M11-00	SPRING, COMPRESSION	1	
35	688-12411-10-00	THERMOSTAT	1	
36	688-12413-00-9M	COVER, THERMOSTAT	1	
37	688-12414-A1-00	.GASKET, COVER	1	
38	97013-06035-00	BOLT	4	
39	92990-06600-00	WASHER, PLATE	4	
40	NGK-B8HS1-00-00	PLUG, SPARK (NGK B8HS-10)	3	
41	688-41111-00-9M	INNER COVER, EXHAUST	1	
42	688-41112-A0-00	GASKET, EXHAUST INNER COVER	2	
43	688-41113-00-9M	OUTER COVER, EXHAUST	1	
44	97313-08040-00	BOLT, HEXAGON	18	
45	92990-08600-00	..WASHER, PLATE	18	
46	90157-06014-00	SCREW, PAN HEAD	1	
47	688-44194-00-00	CAP	1	
48	95380-06700-00	NUT	1	
49	90465-12M03-00	CLAMP	1	
50	97313-06010-00	BOLT, HEXAGON	1	
51	92995-06100-00	WASHER, SPRING	1	

52	663-24312-01-00	PIPE 2	1	
53	90467-08004-00	CLIP	2	
54	6H1-15772-00-00	STAY 2	1	
55	97013-06012-00	BOLT	2	
56	6H1-15773-00-00	STAY 3	1	
57	6H1-21796-00-00	HINGE	1	
58	97313-08012-00	BOLT, HEXAGON	1	
59	6H1-W0001-00-00	POWER HEAD GASKET KIT	1	SEE NOTE

Part Notes

90ETLK 1985 / CRANKCASE CYLINDER

PART NUMBER		NOTE TEXT
92990-06600-00		OEM: This part number is among the Top 100 Most Popular Marine Maintenance Parts as of March 2014.
90480-20M05-00		OEM: This part number is among the Top 100 Most Popular Marine Maintenance Parts as of March 2014.
688-12414-A1-00		OEM: This part number is among the Top 100 Most Popular Marine Maintenance Parts as of March 2014.
92990-06600-00		OEM: This part number is among the Top 100 Most Popular Marine Maintenance Parts as of March 2014.

©2014 Yamaha Motor Corporation, U.S.A. All rights reserved.

90ETLK 1985 / CRANK PISTON

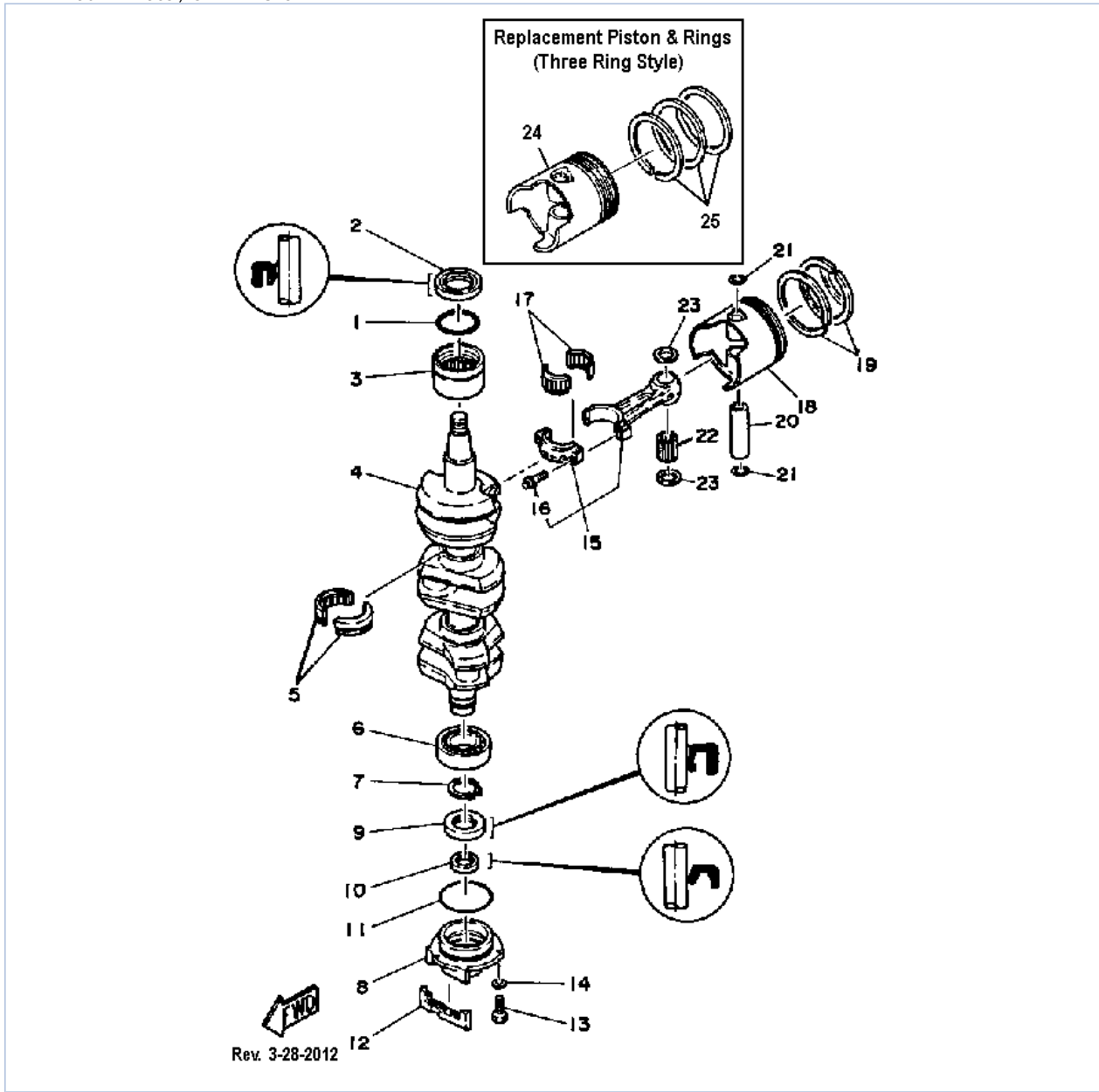



Part List

90ETLK 1985 / CRANK PISTON

REF - NO	PART NUMBER	PART NAME	QUANTITY	REMARKS
1	93210-46M16-00	.O-RING	1	
2	93102-36M24-00	OIL SEAL	1	
3	93310-636U4-00	BEARING	1	
4	688-11411-01-00	CRANKSHAFT	1	
5	93310-835U8-00	BEARING	2	
6	93306-206U5-00	BEARING	1	
7	93410-32M00-00	CIRCLIP	1	
8	6H1-15359-09-94	HOUSING, OIL SEAL	1	
9	93102-30M05-00	.OIL SEAL	1	
10	93104-20M02-00	OIL SEAL	1	
11	93210-62269-00	O-RING	1	
12	688-15379-00-00	SEAL, CRANKCASE	1	
13	97395-06020-00	BOLT, HEXAGON	3	
14	92990-06600-00	WASHER, PLATE	3	
15	688-11650-03-00	CONNECTING ROD ASSY	3	
16	90109-08M61-00	.BOLT	6	
17	93310-730V8-00	BEARING	3	
18	6H1-11631-01-96	PISTON (STD)	3	
18	6H1-11636-02-00	PISTON (2ND O.S.)	3	ALT. PART
19	6H1-11601-20-00	PISTON RINGSET (2ND O.S.)	3	ALT. PART
19	6H1-11601-00-00	PISTON RING (STD)	3	
20	676-11633-00-00	PIN, PISTON	3	
21	688-11634-10-00	CLIP, PISTON PIN	6	
22	93603-21111-00	PIN, DOWEL	84	
23	90201-20417-00	WASHER, PLATE	6	
24	6H1-11636-00-00	PISTON (2ND O.S.)	3	3 RING STYLE
24	6H1-11631-00-96	PISTON (STD)	3	3 RING STYLE
25	6H1-11610-20-00	PISTON RINGSET (2ND O.S.)	3	3 RING STYLE
25	6H1-11610-00-00	PISTON RINGSET (STD)	3	3 RING STYLE

Part Notes

90ETLK 1985 / CRANK PISTON

PART NUMBER	NOTE TEXT
92990-06600-00 	OEM: This part number is among the Top 100 Most Popular Marine Maintenance Parts as of March 2014.
93603-21111-00 	OEM: This part number is among the Top 100 Most Popular Marine Maintenance Parts as of March 2014.

©2014 Yamaha Motor Corporation, U.S.A. All rights reserved.

90ETLK 1985 / AIR CLEANER 1

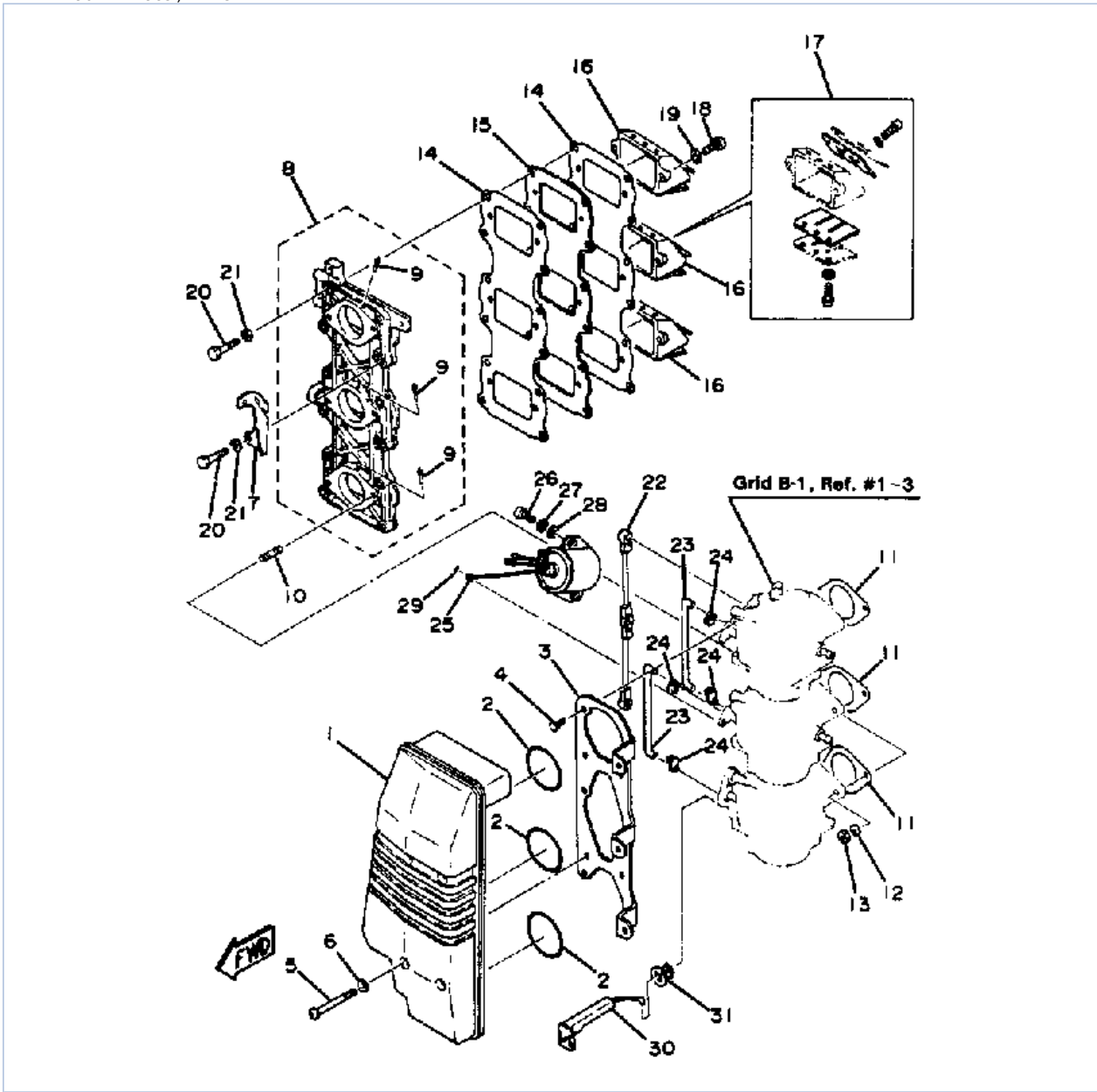

©2014 Yamaha Motor Corporation, U.S.A. All rights reserved.

Part List

90ETLK 1985 / AIR CLEANER 1

REF - NO	PART NUMBER	PART NAME	QUANTITY	REMARKS
1	6H1-14440-02-00	SILENCER ASSY, INTAKE	1	
2	93210-46044-00	O-RING	3	
3	6H1-14413-00-00	STAY 1	1	
4	97013-06012-00	BOLT	6	
5	98580-06055-00	SCREW, PANHEAD	4	
6	90209-06M05-00	WASHER	4	
7	(6H1-21797-00-00)	HINGE	1	
8	6H1-13641-00-94	MANIFOLD 1	1	
9	6H1-14485-00-00	.PIPE, JOINT	3	
10	90116-06122-00	BOLT, STUD	6	
11	688-14198-00-00	GASKET	3	
12	92995-06100-00	WASHER, SPRING	6	
13	95380-06600-00	NUT, HEXAGON	6	
14	688-13621-00-00	GASKET, VALVE SEAT	2	
15	688-13624-00-00	PLATE, REED VALVE	1	
16	688-13610-00-00	REED VALVE ASSY	3	
17	688-W0004-00-00	.REED SET	3	
18	97803-05020-00	SCREW, PAN HEAD	6	
19	92990-05100-00	.WASHER, SPRING	6	
20	97313-06030-00	BOLT	12	
21	92995-06100-00	WASHER, SPRING	12	
22	688-41217-01-00	ROD, ACCEL. LEVER	1	
23	688-41257-00-00	ROD, CHOKE 2	2	
24	661-41262-02-00	JOINT, CHOKE LEVER	4	
25	688-86110-01-00	SOLENOID COIL ASSEMBLY	1	
26	98503-06014-00	SCREW, PAN HEAD	2	
27	92995-06100-00	WASHER, SPRING	2	
28	92990-06200-00	WASHER, PLAIN	2	
29	93210-03261-00	O-RING	1	
30	692-41256-00-00	ROD, CHOKE 1	1	
31	689-41273-00-00	GROMMET	1	

90ETLK 1985 / AIR CLEANER 2

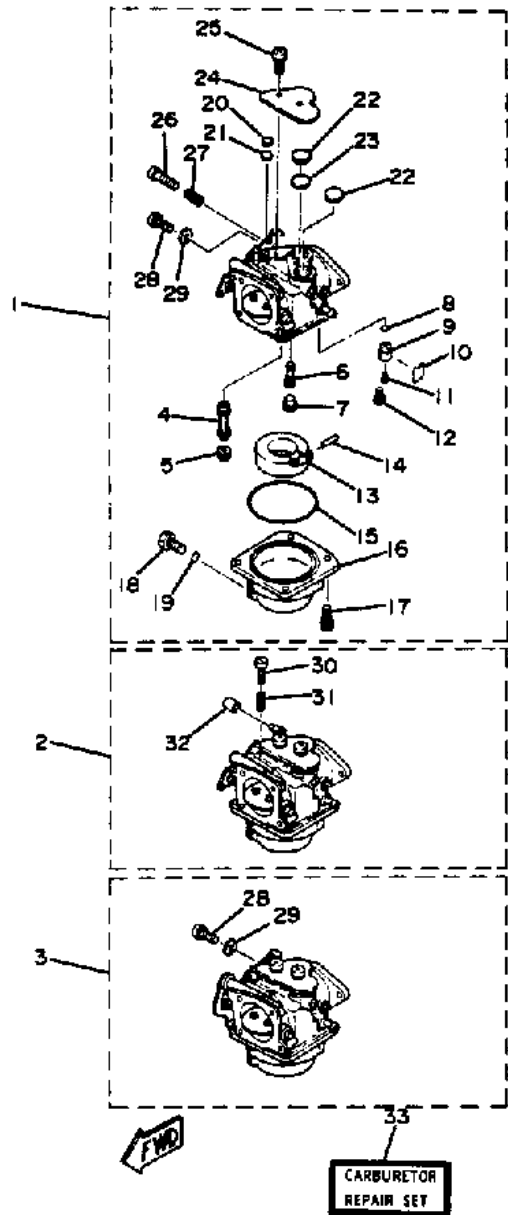

©2014 Yamaha Motor Corporation, U.S.A. All rights reserved.

Part List

90ETLK 1985 / AIR CLEANER 2

REF - NO	PART NUMBER	PART NAME	QUANTITY	REMARKS
1	6H1-14301-15-00	CARBURETOR ASSEMBLY 1	1	
2	6H1-14302-15-00	CARBURETOR ASSEMBLY 2	1	
3	6H1-14303-15-00	CARBURETOR (LOWER)	1	
4	(6H0-14947-00-00)	JET, NEEDLE	3	
5	676-14943-40-00	.JET, MAIN (165)	3	
6	676-14948-18-00	.JET (#78)	3	
7	676-14966-00-00	.CAP	3	
8	93210-04228-00	.O-RING	3	
9	692-14590-00-00	.VALVE SEAT	3	
10	663-14159-00-00	.CLIP	3	
11	676-14186-00-00	PIN, FLOAT	3	
12	98580-04008-00	.SCREW, PAN HEAD	3	
13	676-14985-01-00	.FLOAT	3	
14	688-14548-00-00	.PIN, FLOAT ARM	3	
15	676-14984-00-00	.GASKET, FLOAT CHAMBER	3	
16	688-14980-00-00	.BODY, FLOAT CHAMBER	3	
17	97980-04114-00	.SCREW, WITH WASHER	12	
18	6H3-14992-00-00	.SCREW, DRAIN	3	
19	93210-04230-00	.O-RING	3	
20	663-14126-00-00	.GASKET	3	
21	663-14527-00-00	.PLATE	3	
22	688-14126-00-00	.GASKET	6	
23	688-14527-00-00	.PLATE	3	
24	688-14572-00-00	.PLATE, STAY	3	
25	90159-05017-00	.SCREW, WITH WASHER	6	
26	692-14923-00-00	.SCREW, PILOT	3	
27	679-14555-00-00	.SPRING	3	
28	663-14592-00-00	.SCREW	2	
29	90201-05652-00	.WASHER, PLATE	2	
30	663-14523-00-00	.SCREW, STOP	1	
31	90501-10326-00	.SPRING, COMPRESSION	1	
32	676-14578-00-00	.COLLAR (LOWER)	1	
33	6H1-W0093-01-00	CARBURETOR REPAIR KIT	1	SEE NOTE

90ETLK 1985 / FUEL SYSTEM

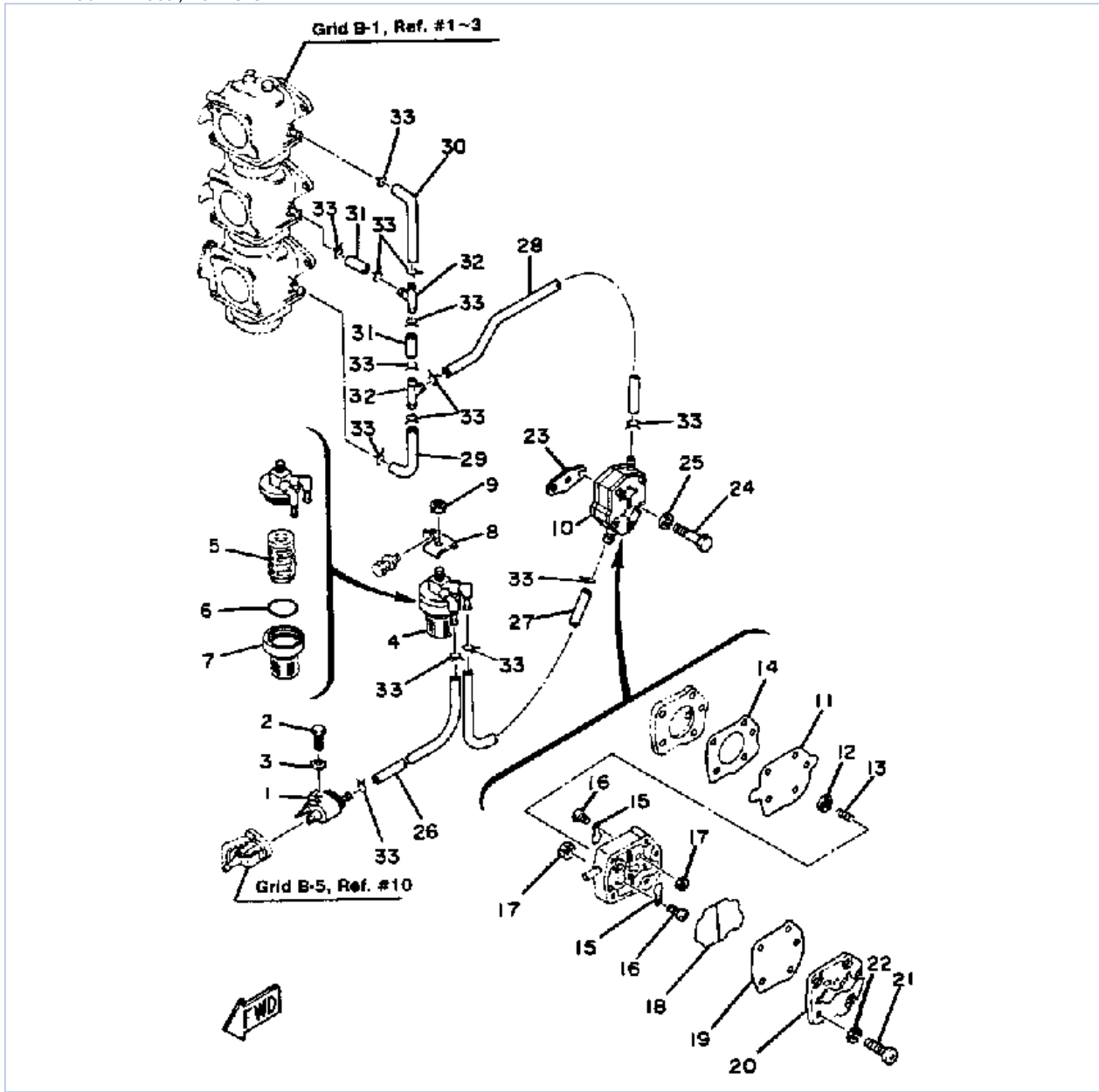

©2014 Yamaha Motor Corporation, U.S.A. All rights reserved.



Part List

90ETLK 1985 / FUEL SYSTEM

REF - NO	PART NUMBER	PART NAME	QUANTITY	REMARKS
1	6G1-24304-02-00	FUEL PIPE JOINT COMP. 1	1	
2	97313-06020-00	BOLT, HEXAGON	1	
3	92995-06100-00	WASHER, SPRING	1	
4	655-24560-01-00	FILTER ASSEMBLY	1	
5	6F5-24563-00-00	.ELEMENT, FILTER	1	
6	93210-37M25-00	.O-RING	1	
7	655-24521-01-00	.CUP, FILTER	1	
8	6H1-24566-00-00	BRACKET, FILTER	1	
9	95333-08600-00	NUT	1	
10	6A0-24410-05-00	FUEL PUMP ASSEMBLY	1	
11	648-24411-00-00	.DIAPHRAGM	1	
12	648-24424-00-00	.SEAT, SPRING	1	
13	648-24423-00-00	.SPRING, DIAPHRAGM	1	
14	648-24434-01-00	.GASKET, BODY	1	
15	6A0-24421-01-00	.VALVE, CHECK	2	
16	90147-03M00-00	.SCREW, PAN HEAD	2	
17	98813-03100-00	.NUT	2	
18	6A0-24435-00-00	.GASKET, BODY 2	1	
19	6A0-24435-00-00	.GASKET, BODY 2	1	
20	6A0-24413-00-00	.BODY 2	1	
21	(98503-05028-00)	SCREW, PAN HEAD	3	
22	92990-05100-00	.WASHER, SPRING	3	
23	650-24431-A0-00	GASKET, FUEL PUMP 1	1	
24	97313-06040-00	BOLT, HEXAGON	2	
25	92990-06600-00	WASHER, PLATE	2	
26	90445-09105-00	HOSE (L300)	1	
27	90445-09074-00	HOSE (L130)	1	
28	90445-09100-00	HOSE (L260)	1	
29	688-24313-00-00	PIPE 3	1	
30	688-24314-00-00	PIPE 4	1	
31	90445-09220-00	HOSE (L30)	2	
32	688-24378-00-00	PIPE, JOINT 3	2	
33	90467-08004-00	CLIP	14	

Part Notes

90ETLK 1985 / FUEL SYSTEM

PART NUMBER		NOTE TEXT
650-24431-A0-00		OEM: This part number is among the Top 100 Most Popular Marine Maintenance Parts as of March 2014.
92990-06600-00		OEM: This part number is among the Top 100 Most Popular Marine Maintenance Parts as of March 2014.

©2014 Yamaha Motor Corporation, U.S.A. All rights reserved.

90ETLK 1985 / FUEL TANK

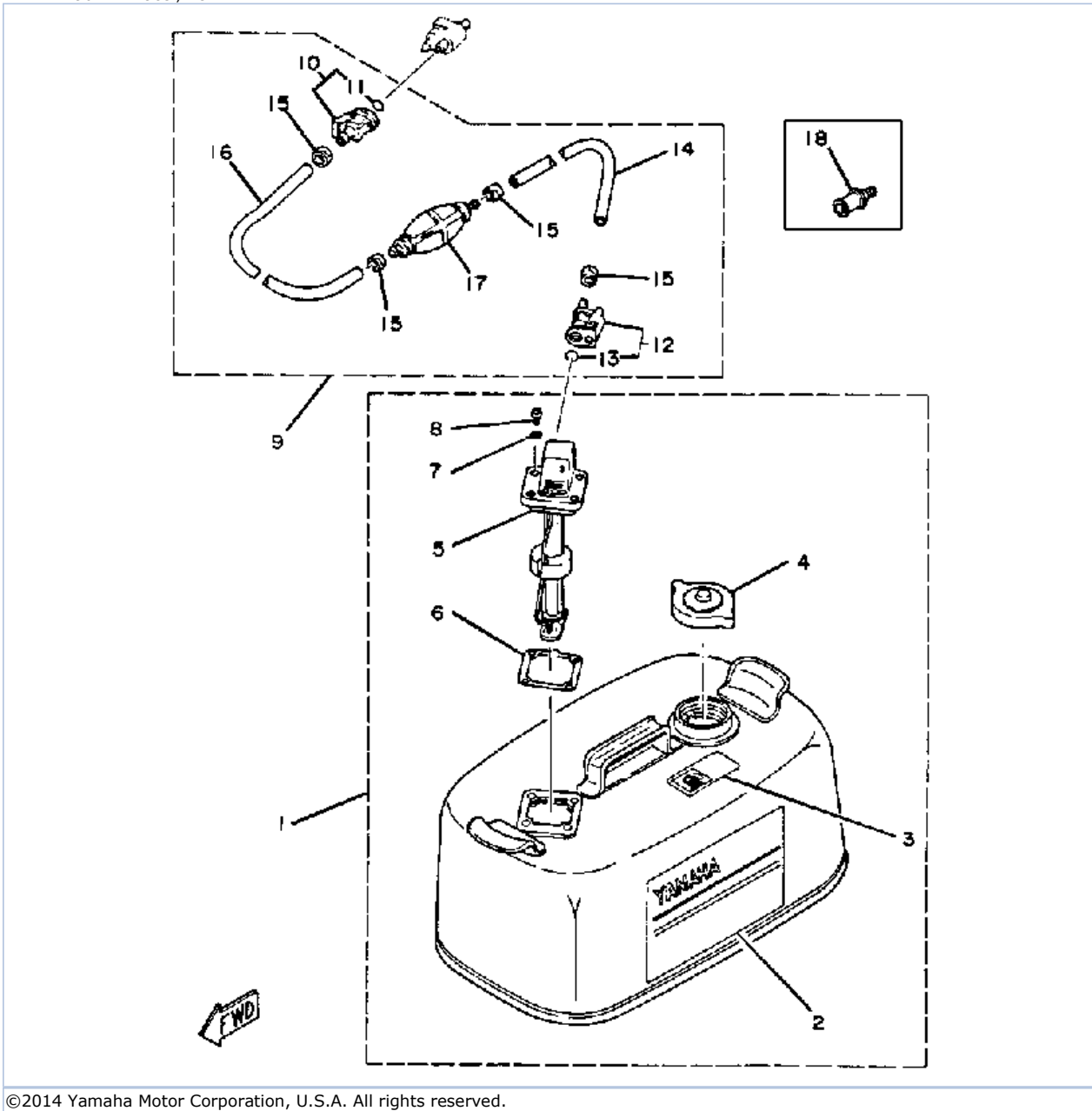

©2014 Yamaha Motor Corporation, U.S.A. All rights reserved.

Part List

90ETLK 1985 / FUEL TANK

REF - NO	PART NUMBER	PART NAME	QUANTITY	REMARKS
1	6Y1-W2420-42-24	FUEL TANK ASSEMBLY	1	
2	6Y1-24244-20-00	.GRAPHIC, SIDE	1	
3	6Y1-24256-50-00	.GRAPHIC, FUEL TANK	1	
4	6Y1-24610-00-00	.CAP ASSEMBLY	1	
5	6Y1-24260-02-00	.FUEL METER ASSEMBLY	1	
6	6Y1-24268-00-00	.GASKET, FUEL METER	1	
7	6Y1-24329-00-00	.SEAL	4	
8	98586-05016-00	.SCREW, PAN HEAD	4	
9	6Y1-24306-51-00	FUEL PIPE COMP. 1	1	
10	6G1-24305-01-00	.FUEL PIPE JOINT COMP 2	1	
11	93210-08287-00	..O-RING	1	
12	6Y1-24305-02-00	.FUEL PIPE JOINT COMP 2	1	
13	93210-08287-00	..O-RING	1	
14	90445-11M80-00	.HOSE	1	
15	650-24351-51-00	.BAND 1	4	
16	90445-11M78-00	HOSE	1	
17	6Y1-24360-51-00	.PRIMER PUMP ASSY	1	
18	ABB-FLUSH-JD-00	JET DRIVE FLUSH	1	

90ETLK 1985 / TOP COWLING

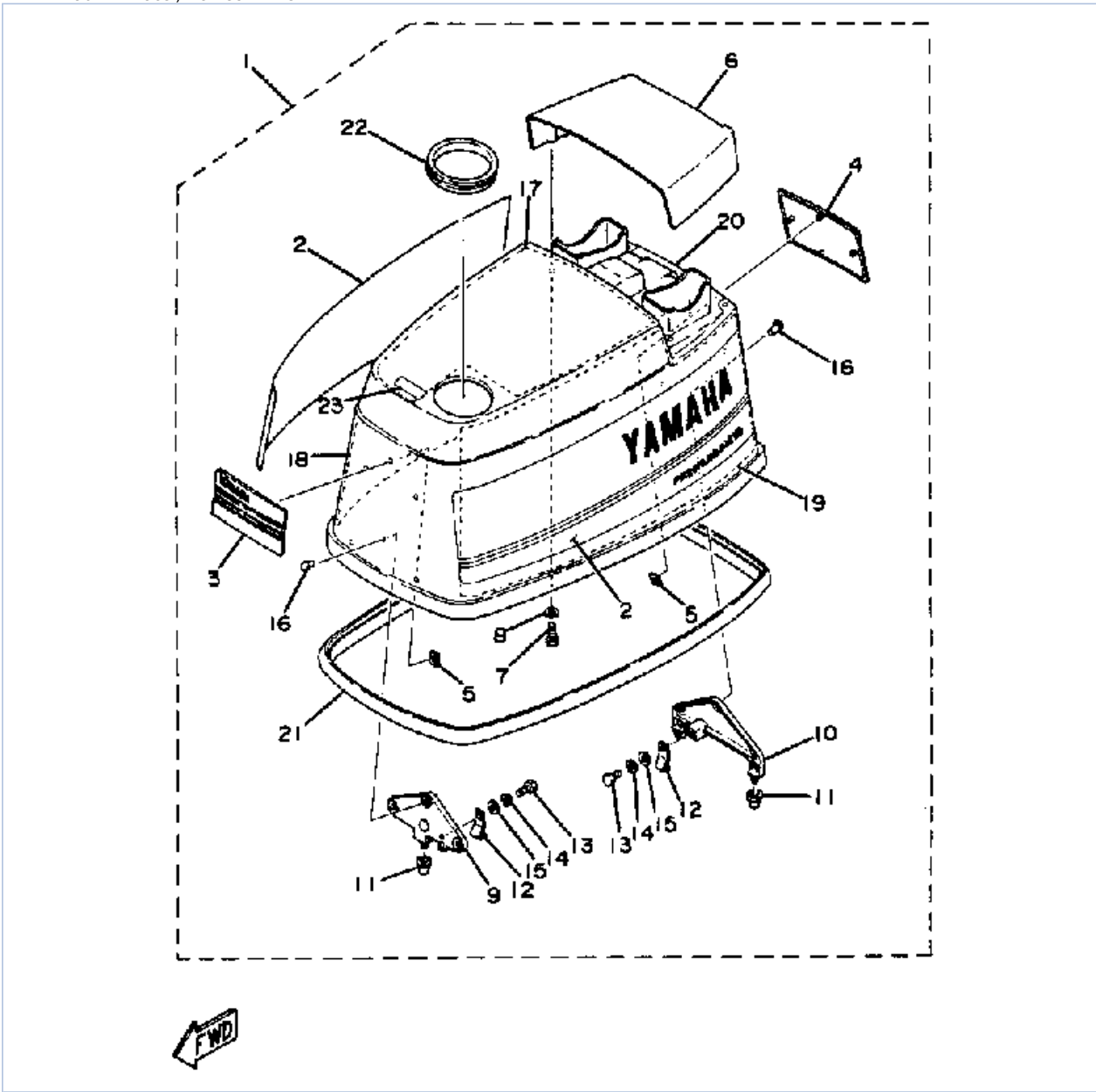

©2014 Yamaha Motor Corporation, U.S.A. All rights reserved.



Part List

90ETLK 1985 / TOP COWLING

REF - NO	PART NUMBER	PART NAME	QUANTITY	REMARKS
1	6H1-42610-41-EK	TOP COWLING ASSEMBLY	1	
2	6H1-W0070-42-00	.GRAPHIC SET	1	
3	6H1-42686-00-00	.EMBLEM, FRONT	1	
4	6H1-42687-00-00	.EMBLEM, REAR	1	
5	90183-05M01-00	.NUT, SPRING	7	
6	6H1-42613-00-EK	.MOLDING, AIR DUCT	1	
7	97313-06016-00	.BOLT, HEXAGON	4	
8	92990-06600-00	.WASHER, PLATE	4	
9	6H1-42647-00-94	.HOLDER, CLAMP BAND	1	
10	6H1-42649-00-94	.HOLDER, CLAMP BAND	1	
11	663-42662-00-00	.DAMPER	3	
12	688-42652-10-00	.HOOK	2	
13	97313-06016-00	.BOLT, HEXAGON	2	
14	92995-06100-00	.WASHER, SPRING	2	
15	92990-06600-00	.WASHER, PLATE	2	
16	90266-06M02-00	.RIVET	6	
17	(6H1-42617-10-00)	RUBBER, FORM 1	1	
18	689-W4266-40-00	.DAMPER, FORM	1	
19	689-W4266-40-00	.DAMPER, FORM	1	
20	(6H1-42637-00-00)	DAMPER, FORM 4	1	
21	688-42615-00-00	.SEAL	1	
22	6H1-21732-00-00	.SEAL 1	1	
23	(6H1-13436-40-00)	MARK	1	

Part Notes

90ETLK 1985 / TOP COWLING

PART NUMBER		NOTE TEXT
92990-06600-00		OEM: This part number is among the Top 100 Most Popular Marine Maintenance Parts as of March 2014.
92990-06600-00		OEM: This part number is among the Top 100 Most Popular Marine Maintenance Parts as of March 2014.

©2014 Yamaha Motor Corporation, U.S.A. All rights reserved.

90ETLK 1985 / BOTTOM COWLING

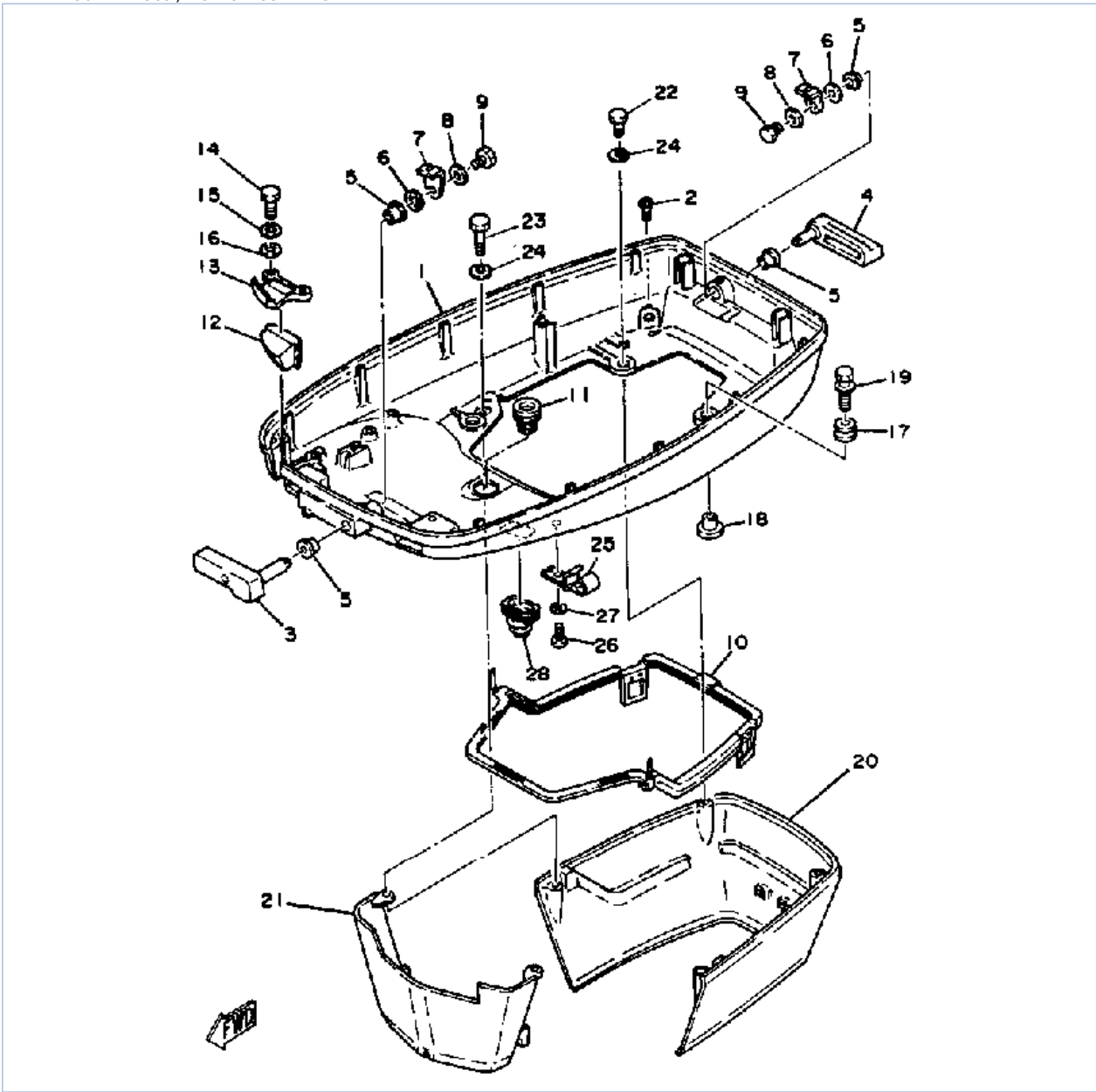

©2014 Yamaha Motor Corporation, U.S.A. All rights reserved.



Part List

90ETLK 1985 / BOTTOM COWLING

REF - NO	PART NUMBER	PART NAME	QUANTITY	REMARKS
1	688-42711-03-EK	BOTTOM COWLING	1	
2	6H3-44391-01-00	NIPPLE, HOSE	1	
3	688-42815-00-EK	LEVER, CLAMP	1	
4	688-42817-00-EK	LEVER, CLAMP 3	1	
5	90386-13M38-00	BUSH	4	
6	90206-13019-00	WASHER, WAVE	2	
7	688-42816-00-00	LEVER, CLAMP 2	2	
8	90201-06M02-00	WASHER, PLATE	2	
9	97013-06012-00	BOLT	2	
10	688-42716-02-00	RUBBER, SEAL 1	1	
11	663-42724-00-00	GROMMET	1	
12	688-42725-10-00	GROMMET	1	
13	688-42738-00-94	PLATE, FITTING	1	
14	97313-06016-00	BOLT, HEXAGON	2	
15	92995-06100-00	WASHER, SPRING	2	
16	92990-06600-00	WASHER, PLATE	2	
17	90480-09M12-00	GROMMET	4	
18	90387-06M69-00	COLLAR	4	
19	90119-06M26-00	BOLT, WITH WASHER	4	
20	688-42741-00-EK	APRON 1	1	
21	688-42771-00-EK	APRON 2	1	
22	97313-06020-00	BOLT, HEXAGON	2	
23	97313-06030-00	BOLT	2	
24	92995-06100-00	WASHER, SPRING	4	
25	6E5-24367-01-00	CLAMP, FUEL PIPE 2	1	
26	90157-06M01-00	SCREW, PAN HEAD	1	
27	92990-06600-00	WASHER, PLATE	1	
28	688-42726-10-00	GROMMET	1	

Part Notes

90ETLK 1985 / BOTTOM COWLING

PART NUMBER	NOTE TEXT
92990-06600-00 	OEM: This part number is among the Top 100 Most Popular Marine Maintenance Parts as of March 2014.
92990-06600-00 	OEM: This part number is among the Top 100 Most Popular Marine Maintenance Parts as of March 2014.

©2014 Yamaha Motor Corporation, U.S.A. All rights reserved.

90ETLK 1985 / BRACKET

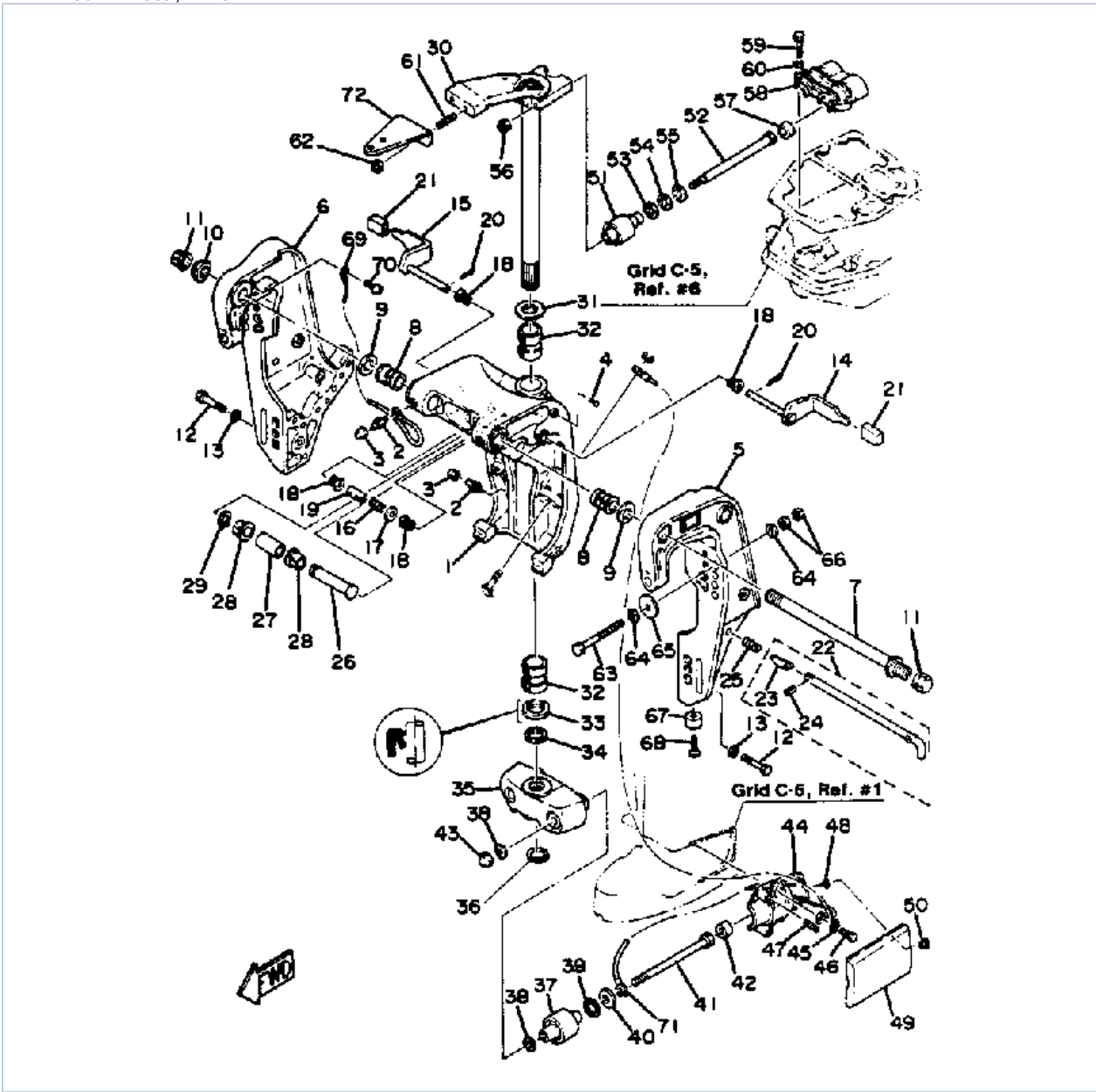

©2014 Yamaha Motor Corporation, U.S.A. All rights reserved.

Part List

90ETLK 1985 / BRACKET

REF - NO	PART NUMBER	PART NAME	QUANTITY	REMARKS
1	688-W4331-14-EK	BRACKET SWIVEL 1	1	
2	93700-06M03-00	NIPPLE, GREASE	3	
3	663-45119-00-00	CAP, GREASE NIPPLE	3	
4	90269-03010-00	RIVET	1	
5	688-43111-12-EK	BRACKET, CLAMP	1	
6	688-43112-12-EK	BRACKET, CLAMP	1	
7	688-43131-03-00	BOLT, CLAMP BRACKET	1	
8	90386-22M15-00	BUSH	2	
9	90201-22M67-00	WASHER, PLATE	2	
10	90185-22043-00	NUT, SELF-LOCKING	1	
11	6G5-43145-00-00	CAP, CLAMP BRACKET	2	
12	97395-10045-00	BOLT	6	
13	92990-10100-00	WASHER, SPRING	6	
14	688-43181-04-00	LEVER, TILT STOP	1	
15	688-43185-04-00	LEVER, TILT STOP	1	
16	90501-10M21-00	SPRING, COMPRESSION	1	
17	92990-10200-00	WASHER, PLAIN	1	
18	90386-10M16-00	BUSH	4	
19	90387-10M38-00	COLLAR	1	
20	91490-30030-00	PIN, COTTER	2	
21	663-43318-00-00	COVER	2	
22	688-43160-01-00	TILT ROD ASSY	1	
23	688-43165-00-00	.PLATE, TILT LOCK	1	
24	91690-30012-00	.PIN, SPRING	1	
25	90502-16M02-00	SPRING, CONICAL	1	
26	6E5-43126-02-00	PIN, UPPER SHOCK MOUNT	1	
27	90386-18M27-00	UNAVAILABLE IN PRICE BOOK	1	
28	90386-18M35-00	BUSH	2	
29	93410-18M02-00	CIRCLIP	1	
30	688-42510-02-EK	STEERING BRACKET ASSY	1	
31	90201-30M00-00	WASHER, PLATE	1	
32	90386-30048-00	BUSH	2	
33	93019-30M03-00	UNAVAILABLE IN PRICE BOOK	1	
34	90201-31418-00	WASHER, PLATE	1	
35	663-44551-01-EK	HOUSING, LWR, MOUNTMOUNT RUBBER	1	
36	93410-28M06-00	CIRCLIP	1	
37	688-44555-00-94	MT.RUBBER LWR.SIDE	2	
38	90201-12M16-00	WASHER, PLATE	4	
39	90202-25M04-00	WASHER, PLATE	2	
40	90201-13M19-00	WASHER, PLATE	2	
41	90109-12261-00	BOLT	2	
42	663-44575-00-00	DAMPER, LOWER MOUNT RUBBER	2	
43	95380-12800-00	NUT, CROWN	2	
44	687-44552-01-94	HOUSING, LOWER MOUNT RUBBER	2	
45	92990-08100-00	WASHER, SPRING	4	
46	97395-08025-00	BOLT	4	
47	90501-14236-00	SPRING, COMPRESSION	4	
48	90179-06066-00	NUT	2	
49	663-44553-00-EK	COVER, LWR.MOUNT	2	
50	98580-06016-00	SCREW, PAN HEAD	2	

51	688-44514-00-94	MOUNT DAMPER, UPPER SIDE	2	
52	90101-10M49-00	BOLT	2	
53	90201-20M21-00	WASHER, PLATE	2	
54	90202-20M06-00	WASHER, PLATE	2	
55	90201-11M22-00	WASHER, PLATE	2	
56	90185-10051-00	NUT, SELF-LOCKING	2	
57	663-44575-00-00	DAMPER, LOWER MOUNT RUBBER	2	
58	688-44511-00-94	COVER, UPPER MOUNT	1	
59	97090-08035-00	BOLT	3	
60	92990-08100-00	WASHER, SPRING	3	
61	90116-10175-00	BOLT, STUD	2	
62	90185-10051-00	NUT, SELF-LOCKING	2	
63	90101-12M65-00	BOLT	4	
64	92990-12200-00	WASHER, PLAIN	8	
65	90201-12426-00	WASHER, PLATE	4	
66	95380-12600-00	NUT	8	
67	688-45251-01-00	ANODE	1	
68	92180-06025-00	SCREW, OVAL HEAD	1	
69	688-82148-00-00	WIRE, LEAD 4	1	
70	97890-06012-00	SCREW, PAN HEAD	1	
71	688-82127-01-00	WIRE, LEAD 2	1	
72	688-48511-11-EK	HOOK STEERING	1	

90ETLK 1985 / POWER TRIM TILT SENDER

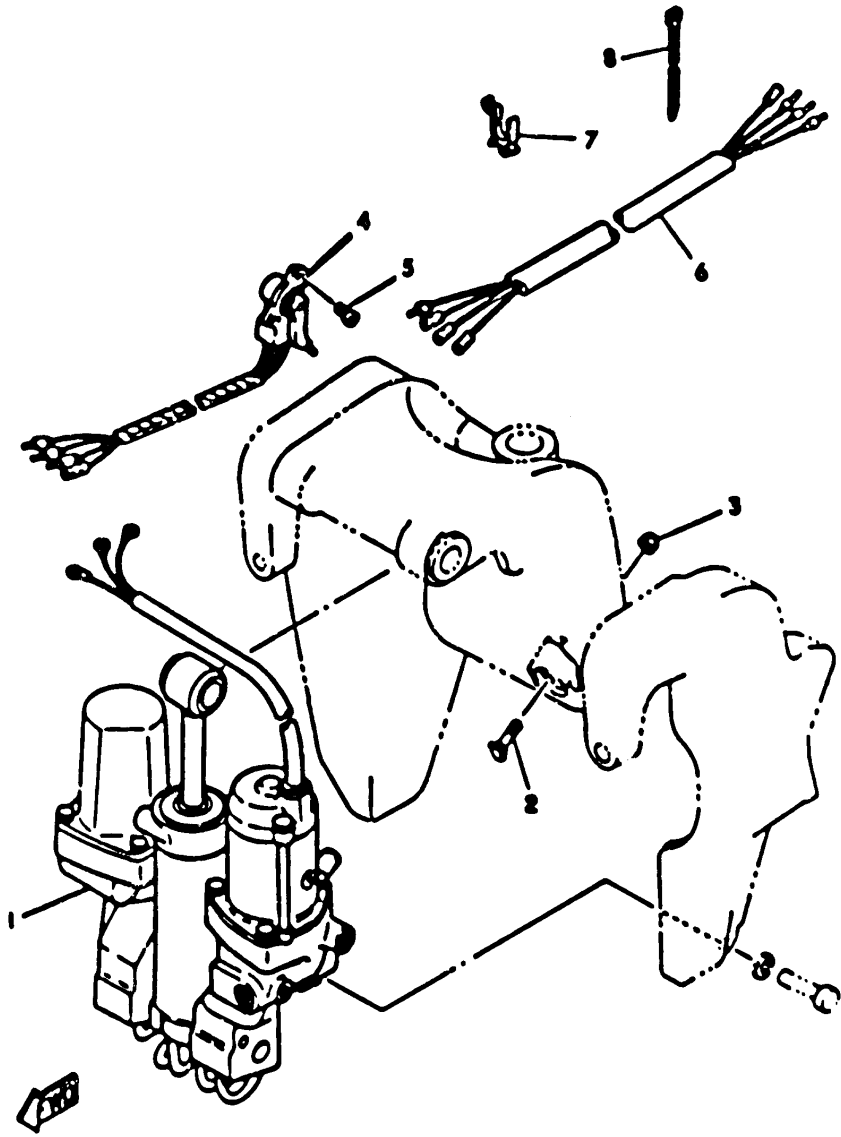

©2014 Yamaha Motor Corporation, U.S.A. All rights reserved.

Part List

90ETLK 1985 / POWER TRIM TILT SENDER

REF - NO	PART NUMBER	PART NAME	QUANTITY	REMARKS
1	6H1-43800-00-EK	POWER TRIM TILT ASSY	1	
2	688-43376-01-00	BOLT, THRUST RECEIVER	2	
3	95780-08300-00	..NUT, FLANGE	2	
4	6E5-83672-01-00	TRIM SENDER	1	
5	98580-06016-00	SCREW, PAN HEAD	2	
6	6E5-82553-00-00	EXTENSION, WIRE	1	
7	90464-15M08-00	CLAMP	1	
8	90465-11M10-00	CLAMP	1	

90ETLK 1985 / CONTROL ENGINE

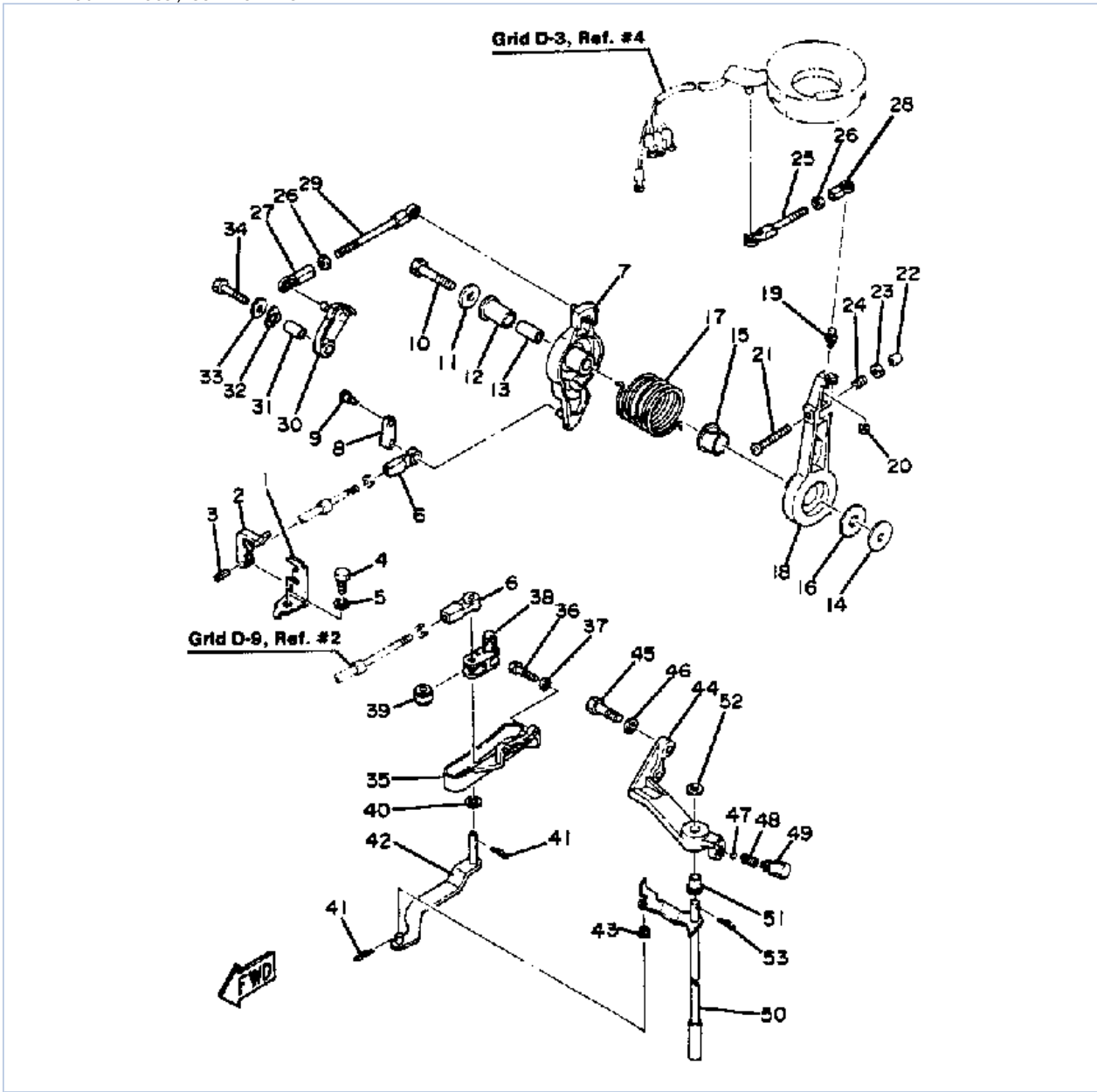

©2014 Yamaha Motor Corporation, U.S.A. All rights reserved.





Part List

90ETLK 1985 / CONTROL ENGINE

REF - NO	PART NUMBER	PART NAME	QUANTITY	REMARKS
1	663-48531-00-00	BRACKET, REMOTE CONTROL	1	
2	663-48538-00-00	CLAMP, CABLE 1	1	
3	91690-30012-00	.PIN, SPRING	1	
4	97313-08016-00	BOLT, HEXAGON	1	
5	92990-08100-00	WASHER, SPRING	1	
6	663-48344-00-00	.CABLE END, REMOTE CONTROL	2	
7	(688-41632-00-94)	LEVER, MAG.CONTR.2	1	
8	688-44171-00-00	LOCK LEVER	1	
9	90249-05125-00	PIN	1	
10	97313-08045-00	BOLT, HEXAGON	1	
11	90201-08M54-00	WASHER, PLATE	1	
12	90386-12089-00	BUSH	1	
13	90387-08M16-00	COLLAR	1	
14	90201-08M13-00	WASHER, PLATE	1	
15	90386-22M13-00	BUSH	1	
16	90202-12092-00	WASHER, PLATE	1	
17	90508-29M05-00	SPRING, TORSION	1	
18	688-41631-01-94	LEVER, MAGNETO CONTROL	1	
19	663-85518-00-00	JOINT, BALL	1	
20	95303-05700-00	.NUT	1	
21	90157-06M11-00	SCREW, PAN HEAD	1	
22	688-44194-00-00	CAP	1	
23	95380-06600-00	NUT, HEXAGON	1	
24	90501-16M12-00	SPRING, COMPRESSION	1	
25	688-41636-00-00	ROD, MAGNETO CONTROL	1	
26	95380-05600-00	NUT	2	
27	682-41237-00-00	JOINT, LINK	1	
28	6H1-41237-00-00	JOINT, LINK	1	
29	688-41211-01-00	LINK, ACCEL.	1	
30	688-41213-00-00	CAM, ACCEL.	1	
31	90387-06M17-00	COLLAR	1	
32	90206-10M04-00	WASHER, WAVE	1	
33	90201-06M02-00	WASHER, PLATE	1	
34	97013-06035-00	BOLT	1	
35	688-44117-00-94	BRACKET	1	
36	97313-06020-00	BOLT, HEXAGON	2	
37	92990-06600-00	WASHER, PLATE	2	
38	688-44124-00-00	LINK, SHIFT ROD	1	
39	688-44122-00-00	BUSHING, SHIFT ROD LEVER	1	
40	90202-07M07-00	WASHER, PLATE	1	
41	90468-18008-00	CLIP	3	
42	6H1-44121-00-00	LEVER, SHIFT ROD	1	
43	90386-06M12-00	BUSH	1	
44	688-44118-00-94	BRACKET	1	
45	97313-08030-00	BOLT	2	
46	92990-08100-00	WASHER, SPRING	2	
47	93501-04M02-00	BALL	1	
48	90501-12082-00	SPRING, COMPRESSION	1	
49	648-42715-00-00	BUSHING	1	
50	6H1-44120-10-00	HDL.GEAR SHFT	1	U.R. LONG
51	90386-08006-00	BUSH	1	
52	92990-08200-00	WASHER, PLAIN	1	
53	90468-18008-00	CLIP	1	

Part Notes

90ETLK 1985 / CONTROL ENGINE

PART NUMBER		NOTE TEXT
6H1-41237-00-00		OEM: This part number is among the Top 100 Most Popular Marine Maintenance Parts as of March 2014.
92990-06600-00		OEM: This part number is among the Top 100 Most Popular Marine Maintenance Parts as of March 2014.
90468-18008-00		OEM: This part number is among the Top 100 Most Popular Marine Maintenance Parts as of March 2014.
90468-18008-00		OEM: This part number is among the Top 100 Most Popular Marine Maintenance Parts as of March 2014.

©2014 Yamaha Motor Corporation, U.S.A. All rights reserved.

90ETLK 1985 / UPPER CASING

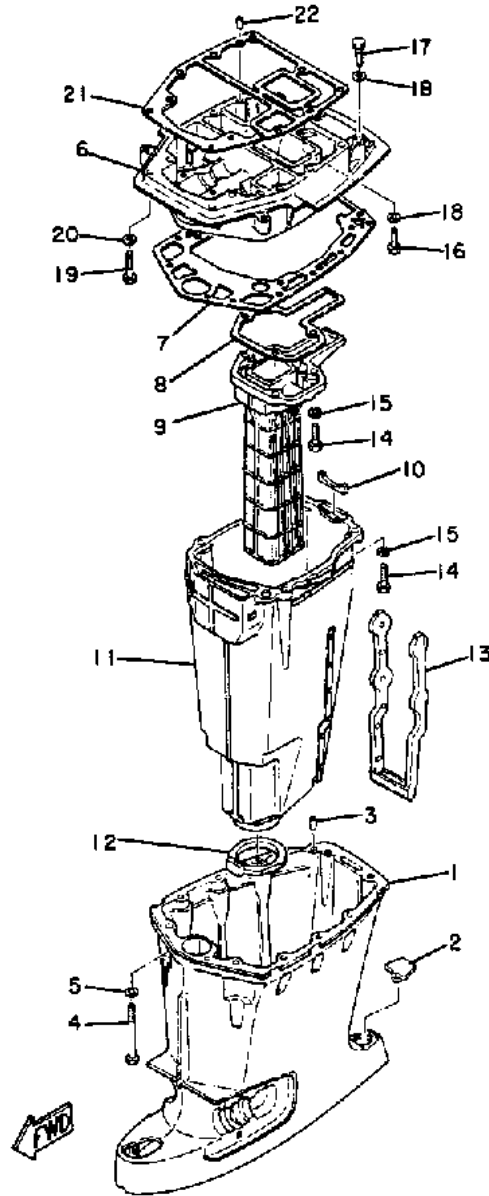

©2014 Yamaha Motor Corporation, U.S.A. All rights reserved.

Part List

90ETLK 1985 / UPPER CASING

REF - NO	PART NUMBER	PART NAME	QUANTITY	REMARKS
1	688-45111-03-EK	CASING, UPPER	1	
2	663-45155-10-00	CAP	1	
3	93606-12019-00	.PIN, DOWEL	2	
4	90119-08M80-00	BOLT, WITH WASHER	8	
5	92990-08100-00	WASHER, SPRING	8	
6	688-41137-02-94	GUIDE, EXHAUST	1	
7	688-45114-A1-00	GASKET, UPPER CASING	1	
8	688-41134-A0-00	GASKET, EXHAUST MANIFOLD	1	
9	688-41131-00-5B	MANIFOLD, EXT. 1	1	
10	688-41133-00-00	GASKET, EXHAUST MANIFOLD 1	1	
11	688-14711-00-9M	MUFFLER L	1	
12	688-45123-00-00	GASKET, MUFFLER	1	
13	663-14737-10-00	DAMPER, MUFFLER	1	
14	97395-08030-00	BOLT	7	
15	92990-08100-00	WASHER, SPRING	7	
16	97395-08025-00	BOLT	1	
17	97395-08030-00	BOLT	2	
18	92990-08100-00	WASHER, SPRING	3	
19	97090-08035-00	BOLT	2	
20	92990-08100-00	WASHER, SPRING	2	
21	688-45113-A0-00	GASKET, UPPER CASING	1	
22	93606-12019-00	.PIN, DOWEL	2	

Part List







90ETLK 1985 / LOWER DRIVE 1

REF - NO	PART NUMBER	PART NAME	QUANTITY	REMARKS
1	6H1-45300-13-EK	LOWER UNIT ASSEMBLY	1	UR LONG
2	6H1-45301-02-EK	LOWER CASING	1	
3	688-45214-02-00	COVER, WATER INLET 1	1	
4	688-45215-02-00	COVER, WATER INLET 2	1	
5	98680-05545-00	SCREW, OVAL HEAD	1	
6	90185-05002-00	NUT, NYLON	1	
7	90340-08M04-00	PLUG, STRAIGHT SCREW	2	
8	688-45341-00-00	PLUG, DRAIN	1	
9	90430-08020-00	.GASKET	3	
10	688-45321-00-00	PLATE	1	
11	93210-49046-00	.O-RING	1	
12	93106-09014-00	.OIL SEAL	1	
13	97395-06016-00	BOLT, HEX	2	
14	92990-06600-00	WASHER, PLATE	2	
15	6H1-44144-00-00	ROD, SHIFT	1	
16	99001-08600-00	CIRCLIP	1	
17	93210-07540-00	.O-RING	1	
18	93450-07M00-00	CIRCLIP	1	
19	688-44311-01-00	HOUSING, WATER PUMP	1	
20	688-44322-00-00	INSERT, CARTRIDGE	1	
21	688-44352-03-00	IMPELLER	1	
22	688-44315-A0-00	.GASKET, WATER PUMP	1	
23	688-44323-00-00	OUTER PLATE, CARTRIDGE	1	
24	688-44324-A0-00	.GASKET, CARTRIDGE	1	
25	688-44341-00-94	HOUSING, WATER PUMP	1	
26	688-44316-A0-00	.GASKET, WATER PUMP	1	
27	93210-46044-00	O-RING	1	
28	93101-25M03-00	.OIL SEAL	2	
29	93604-10M03-00	PIN, DOWEL	2	
30	97395-08050-00	BOLT	2	
31	97395-08070-00	BOLT	2	
32	90209-08M02-00	WASHER	4	
33	6H1-45501-11-00	DRIVE SHAFT COMP.	1	
34	90280-04M04-00	.KEY, WOODRUFF	1	
35	93332-000U3-00	BEARING	1	
36	688-45587-00-05	SHIM 3	1	UR
36	688-45587-00-08	SHIM 3	1	UR
36	688-45587-01-12	SHIM (T:0.12MM)	1	UR
36	688-45587-01-30	SHIM (T:0.30MM)	1	UR
37	688-45536-01-00	SLEEVE, DRIVE SHAFT	1	
38	93315-325V1-00	BEARING	1	
39	688-45551-01-00	PINION (13T)	1	
40	90170-16M01-00	NUT	1	
41	6H1-44151-00-00	CAM, SHIFT	1	
42	6H1-45635-00-00	PLUNGER, SHIFT	2	
43	6H1-45634-00-00	SHIFT SLIDE	1	
44	90501-12M48-00	SPRING, COMPRESSION	1	
45	93503-16010-00	BALL 3-16	2	
46	90183-02M03-00	NUT, SPRING	2	
47	90201-03313-00	WASHER, PLATE	1	
48	6H1-45668-00-00	SHAFT, FREE 1	1	
49	6H1-45641-00-00	REF;SRV:BUL#85-011	1	
50	688-45567-00-05	SHIM	1	UR

50	688-45567-00-08	SHIM	1	UR
50	688-45567-01-12	SHIM (T:0.12MM)	1	UR
50	688-45567-01-30	SHIM (T:0.30MM)	1	UR
50	688-45567-01-50	SHIM (T:0.50MM)	1	UR
51	93332-000U5-00	BEARING	1	
52	6H1-45560-00-00	GEAR 1 ASSEMBLY	1	
53	6H1-45631-00-00	CLUTCH, DOG	1	
54	90250-07M02-00	PIN, STRAIGHT	1	
55	688-45633-00-00	RING, CROSS PIN	1	
56	6H1-45611-00-00	SHAFT, PROPELLER	1	
57	6H1-45571-00-00	GEAR 2 (26T)	1	
58	688-45577-00-05	SHIM	1	UR
58	688-45577-00-08	SHIM	1	UR
58	688-45577-01-12	SHIM (T:0.12MM)	1	UR
58	688-45577-01-30	SHIM (T:0.30MM)	1	
58	688-45577-01-50	SHIM (T:0.50MM)	1	UR
59	688-45576-00-00	WASHER, THRUST	1	
60	93306-207U0-00	.BEARING	1	
61	93210-85M97-00	O-RING	1	
62	688-45331-00-94	HOUSING, BEARING	1	
63	90282-04010-00	KEY, STRAIGHT	1	
64	93317-325U0-00	BEARING	1	
65	93101-25M03-00	.OIL SEAL	2	
66	688-45383-02-00	WASHER, CLAW	1	
67	688-45384-00-00	NUT	1	
68	6E5-45378-00-00	NIPPLE, HOSE	1	
68	6E5-45378-00-00	NIPPLE, HOSE	1	
70	6E5-83558-00-00	END, NIPPLE	1	
71	90465-11M10-00	CLAMP	2	
72	90465-11M10-00	CLAMP	1	
73	688-W0001-20-00	LOWER UNIT GASKET KIT	1	SEE NOTE
74	692-W0078-00-00	WATER PUMP REPAIR KIT	1	SEE NOTEALT. PARTS
75	688-W0078-1A-00	CHROME PUMP KIT	1	
76	688-44321-41-00	.INSERT, CARTRIDGE	1	
77	688-44322-41-00	.INSERT, CARTRIDGE	1	
78	688-44323-40-00	.OUTER PLATE, CARTRIDGE	1	

Part Notes

90ETLK 1985 / LOWER DRIVE 1

PART NUMBER		NOTE TEXT
90430-08020-00		OEM: This part number is among the Top 100 Most Popular Marine Maintenance Parts as of March 2014.
93106-09014-00		OEM: This part number is among the Top 100 Most Popular Marine Maintenance Parts as of March 2014.
92990-06600-00		OEM: This part number is among the Top 100 Most Popular Marine Maintenance Parts as of March 2014.
688-44352-03-00		OEM: This part number is among the Top 100 Most Popular Marine Maintenance Parts as of March 2014.
93101-25M03-00		OEM: This part number is among the Top 100 Most Popular Marine Maintenance Parts as of March 2014.
93101-25M03-00		OEM: This part number is among the Top 100 Most Popular Marine Maintenance Parts as of March 2014.

©2014 Yamaha Motor Corporation, U.S.A. All rights reserved.

90ETLK 1985 / LOWER DRIVE 2

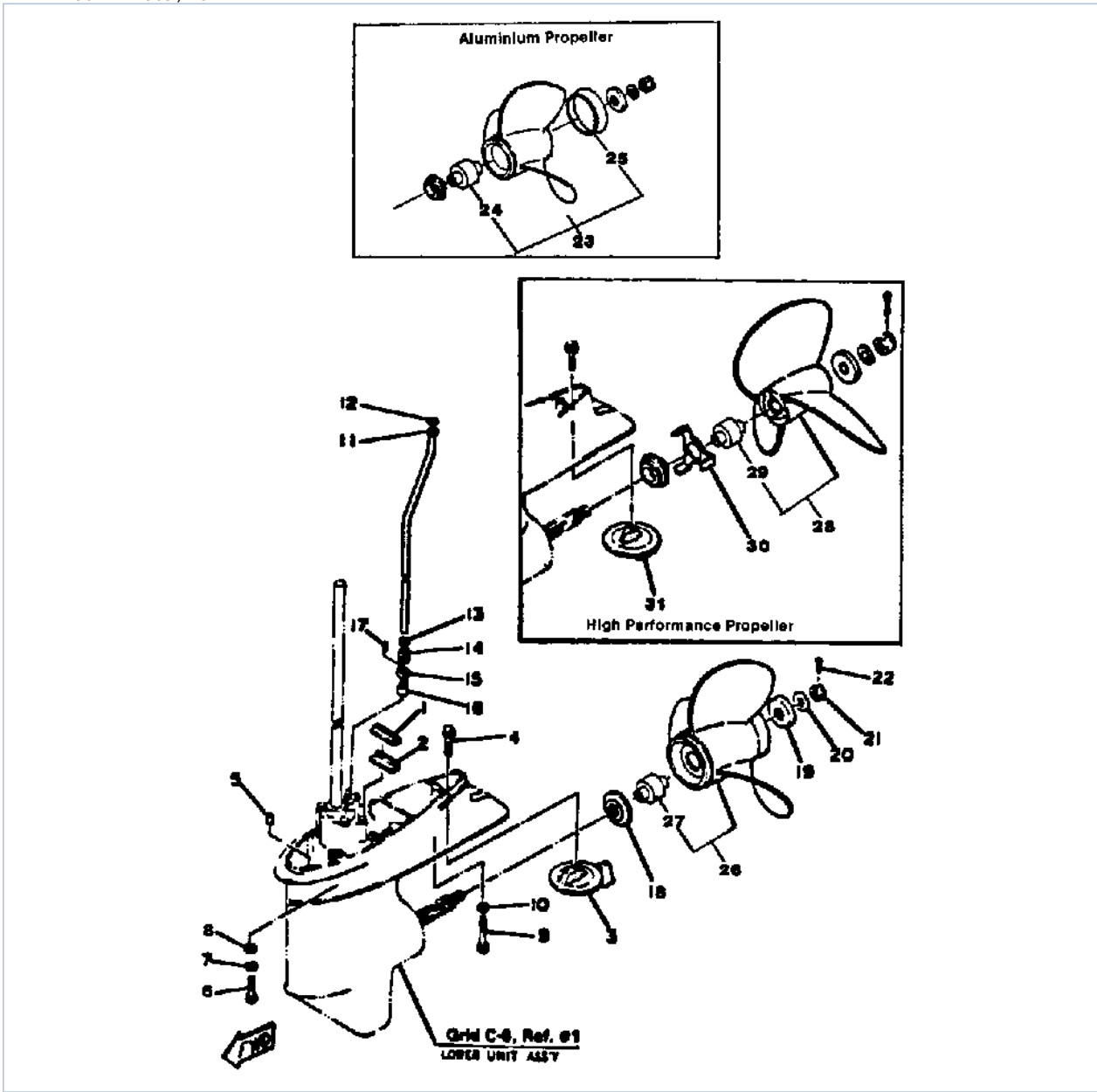

©2014 Yamaha Motor Corporation, U.S.A. All rights reserved.





Part List

90ETLK 1985 / LOWER DRIVE 2

REF - NO	PART NUMBER	PART NAME	QUANTITY	REMARKS
1	688-45375-00-00	DAMPER, SEAL	1	
2	663-45376-00-94	GUIDE, SEAL DAMPER	1	
3	688-45371-02-00	TAB-TRIM	1	
4	90105-10M00-00	BOLT, FLANGE	1	
5	93606-12019-00	.PIN, DOWEL	2	
6	97395-10040-00	BOLT	4	
7	92990-10100-00	WASHER, SPRING	4	
8	92990-10600-00	WASHER, PLATE	4	
9	97395-08060-00	BOLT, HEXAGON	1	
10	92990-08100-00	WASHER, SPRING	1	
11	688-44361-10-00	TUBE, WATER	1	UR LONG
12	90202-12060-00	WASHER, PLATE	1	
13	90430-12072-00	GASKET	1	
14	663-44367-00-00	DAMPER, WATER SEAL 3	1	
15	90480-19M06-00	GROMMET	1	
16	663-44366-00-00	.DAMPER, WATER SEAL 2	1	
17	97780-40112-00	SCREW, TAPPING	2	
18	688-45987-01-00	SPACER 1	1	
19	688-45997-01-00	SPACER 2	1	
20	90201-17M00-00	WASHER, PLATE	1	
21	90171-16011-00	NUT, CASTLE	1	
22	91490-40030-00	PIN. COTTER	1	
23	6E5-45945-01-EL	PROPELLER (3X13-1/4"X17"-K)	1	U.R.
23	6E5-45945-01-EL	PROPELLER (3X13-1/4"X17"-K)	1	U.R.
23	6E5-45945-01-EL	PROPELLER (3X13-1/4"X17"-K)	1	U.R.
23	6E5-45941-00-EL	PROPELLER (3X13"X19"-K)	1	U.R.
24	688-45981-00-00	.DAMPER, PROPELLER	1	
25	688-45986-00-94	.RING, DEFLECTOR	1	
26	688-45930-01-98	PROPELLER (3X13"X17"-K)	1	STAINLESS STEEL PROPELLERU.R.
26	688-45970-03-98	PROPELLER (3 X 13-1/2" X 19" -K) ()	1	STAINLESS STEEL PROPELLERU.R.
26	688-45972-02-98	PROPELLER (3X13"X21"-K)	1	STAINLESS STEEL PROPELLERU.R.
26	688-45978-60-98	PROPELLER (3X13-1/2"X16"-K)	1	STAINLESS STEEL PROPELLERU.R
27	688-45981-00-00	.DAMPER, PROPELLER	1	STAINLESS STEEL PROPELLER
28	6E5-45970-10-00	PROPELLER (3X14"X20"-P)	1	HIGH PERFORMANCE PROPELLERU.R.
28	6E5-45976-10-00	PROPELLER (3X14"X22"-P)	1	HIGH PERFORMANCE PROPELLERU.R.
29	6G5-45981-00-00	.DAMPER RUBBER, PROPELLER	1	HIGH PERFORMANCE PROPELLER
30	6E5-45994-10-00	PLATE, TOOTH	1	HIGH PERFORMANCE PROPELLERU.R.
31	6E5-45371-10-00	TAB-TRIM	1	HIGH PERFORMANCE PROPELLERU.R.

Part Notes

90ETLK 1985 / LOWER DRIVE 2

PART NUMBER	NOTE TEXT
90105-10M00-00 	OEM: This part number is among the Top 100 Most Popular Marine Maintenance Parts as of March 2014.
92990-10600-00 	OEM: This part number is among the Top 100 Most Popular Marine Maintenance Parts as of March 2014.
688-45997-01-00 	OEM: This part number is among the Top 100 Most Popular Marine Maintenance Parts as of March 2014.
91490-40030-00 	OEM: This part number is among the Top 100 Most Popular Marine Maintenance Parts as of March 2014.

©2014 Yamaha Motor Corporation, U.S.A. All rights reserved.

90ETLK 1985 / CDI MAGNETO

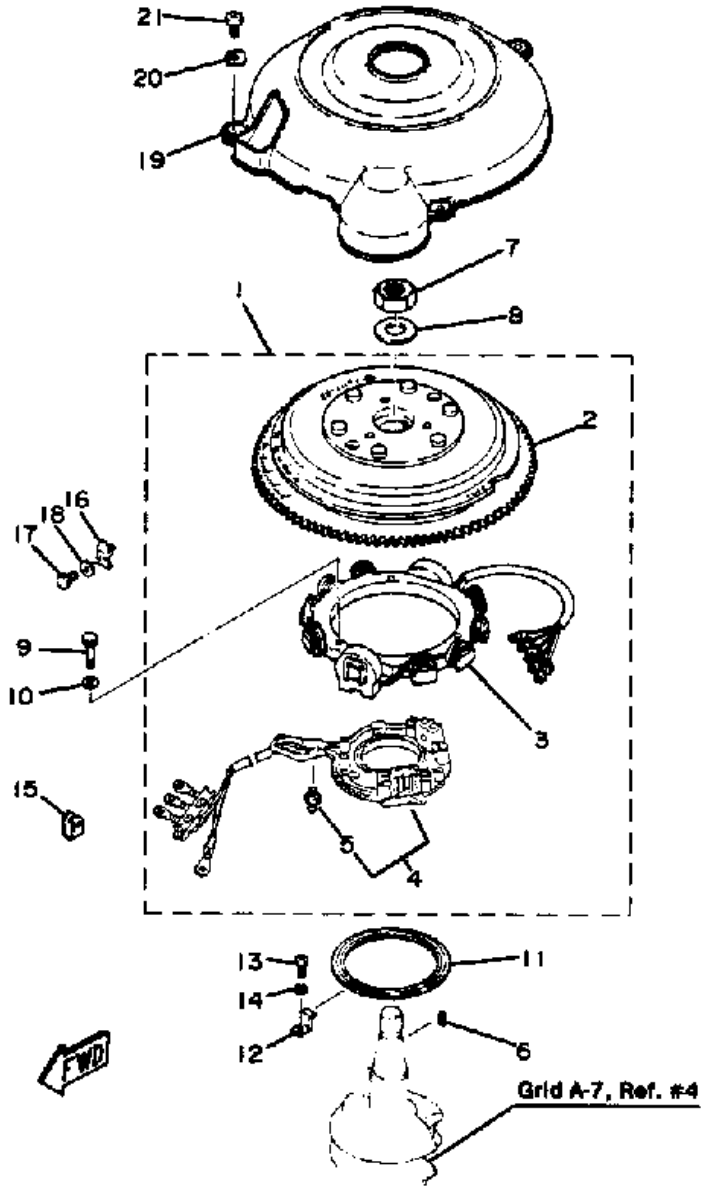

©2014 Yamaha Motor Corporation, U.S.A. All rights reserved.



Part List

90ETLK 1985 / CDI MAGNETO

REF - NO	PART NUMBER	PART NAME	QUANTITY	REMARKS
2	688-85550-13-00	.ROTOR ASSEMBLY	1	SEE NOTE
2	688-85550-11-00	.ROTOR ASSEMBLY	1	
3	688-85510-11-00	.STATOR ASSEMBLY	1	
4	688-85580-12-00	.COIL, PULSER	1	SEE NOTE
4	688-85580-11-00	.PULSER COIL ASSEMBLY (688-85580-10)	1	
5	663-85518-00-00	..JOINT, BALL	1	
6	90280-05049-00	KEY, WOODRUFF	1	
7	90170-20137-00	NUT	1	
8	90201-21M18-00	WASHER, PLATE	1	
9	97313-06025-00	BOLT	3	
10	92990-06600-00	WASHER, PLATE	3	
11	688-41611-00-00	RETAINER, MAGNETO BASE	1	
12	688-41612-00-00	RETAINER, MAGNETO BASE	3	
13	98580-06012-00	SCREW, PAN HEAD	3	
14	92995-06100-00	WASHER, SPRING	3	
15	90464-12M00-00	CLAMP	1	
16	688-81332-01-00	PLATE, TIMING	1	
17	97313-06010-00	BOLT, HEXAGON	1	
18	92990-06600-00	WASHER, PLATE	1	
19	6H1-81337-01-00	COVER, FLYWHEEL	1	
20	90209-06M04-00	WASHER	3	
21	98580-06012-00	SCREW, PAN HEAD	3	

Part Notes

90ETLK 1985 / CDI MAGNETO

PART NUMBER	NOTE TEXT
92990-06600-00 	OEM: This part number is among the Top 100 Most Popular Marine Maintenance Parts as of March 2014.
92990-06600-00 	OEM: This part number is among the Top 100 Most Popular Marine Maintenance Parts as of March 2014.

©2014 Yamaha Motor Corporation, U.S.A. All rights reserved.

90ETLK 1985 / ELECTRIC STARTER

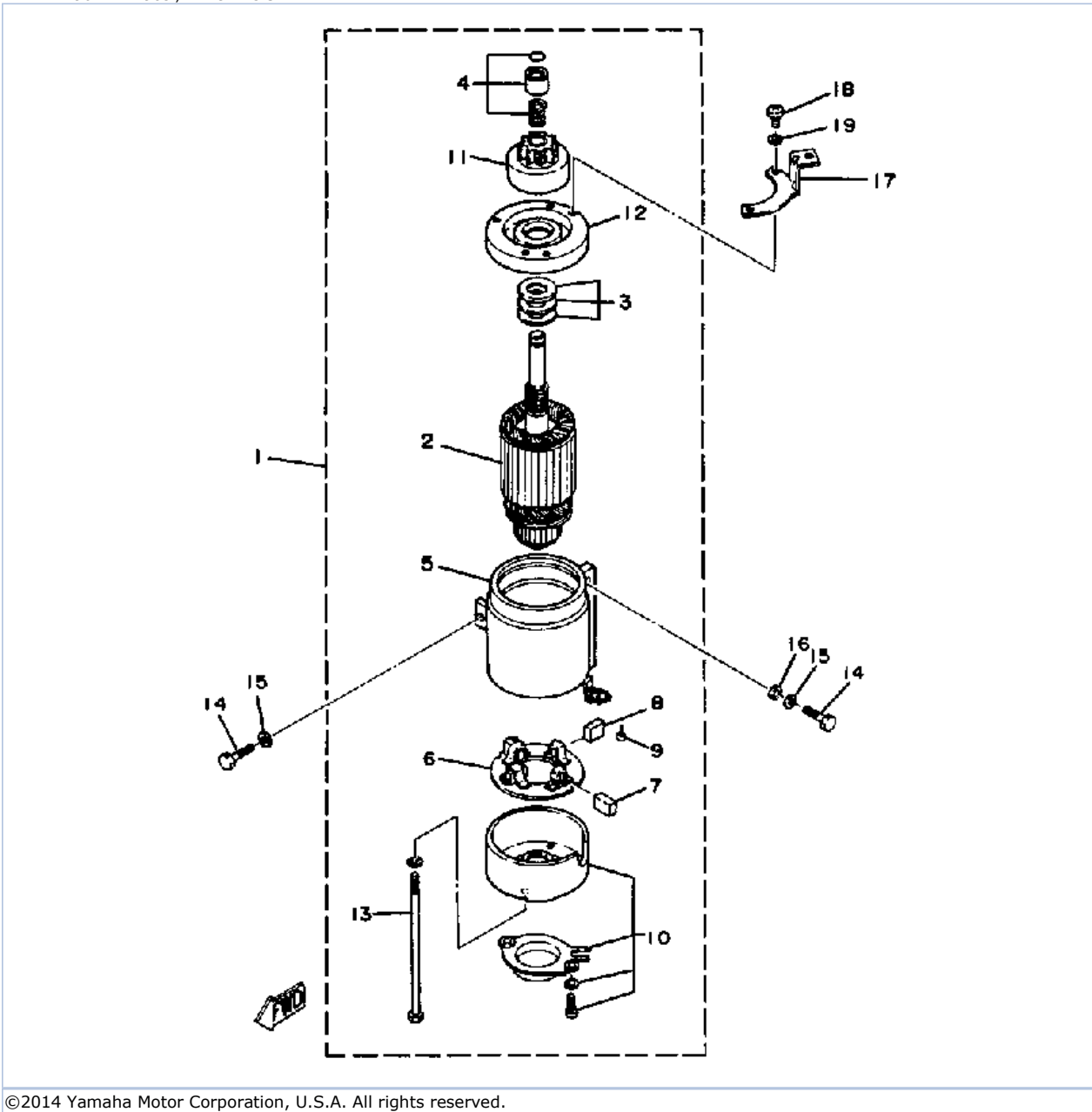

©2014 Yamaha Motor Corporation, U.S.A. All rights reserved.

Part List

90ETLK 1985 / ELECTRIC STARTER

REF - NO	PART NUMBER	PART NAME	QUANTITY	REMARKS
1	688-81800-12-00	STARTING MOTOR ASSY	1	
2	676-81850-A9-00	.ARMATURE ASSEMBLY	1	
3	676-81809-10-00	.WASHER KIT	1	
4	676-81857-10-00	.PINION STOPPER SET	1	
5	688-81810-10-00	.STATOR ASSEMBLY	1	
6	663-81840-11-00	.BRUSH HOLDER ASSY	1	
7	663-81811-11-00	.BRUSH 1	2	
8	663-81812-11-00	.BRUSH 2	2	
9	663-81813-10-00	.SPRING, BRUSH	4	
10	663-81820-11-00	.REAR BRACKET ASSEMBLY	1	
11	663-81832-11-00	.PINION ASSY	1	
12	688-81830-10-00	.FRONT BRACKET ASSEMBLY	1	
13	663-81826-10-00	.BOLT	2	
14	97313-08030-00	BOLT	3	
15	92990-08100-00	WASHER, SPRING	3	
16	92990-08600-00	..WASHER, PLATE	2	
17	6H1-15771-00-00	STAY 1	1	
18	(97803-04010-00)	SCREW, PAN HEAD	2	
19	92990-04200-00	WASHER	2	

90ETLK 1985 / ELECTRIC PARTS 1

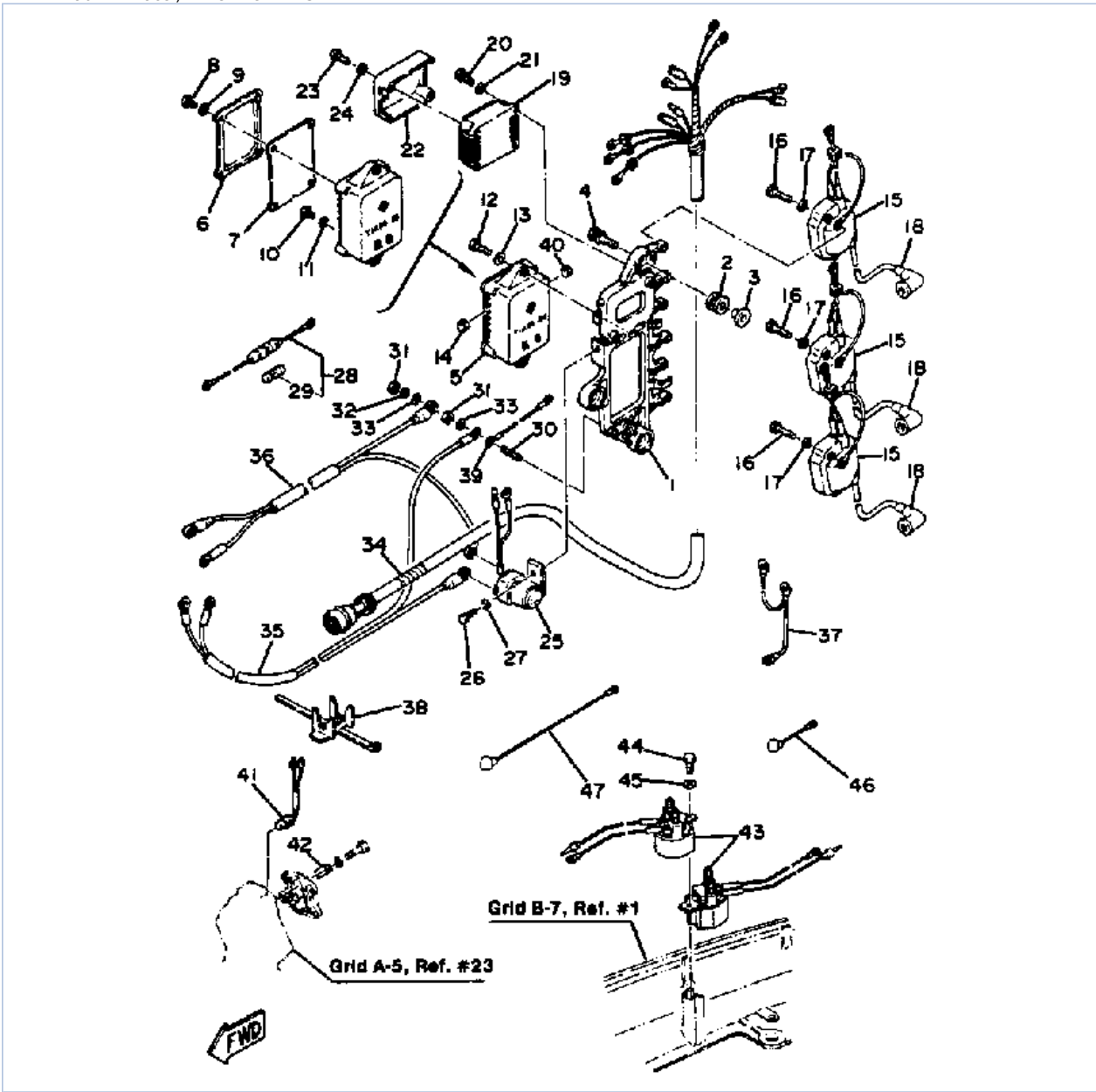

©2014 Yamaha Motor Corporation, U.S.A. All rights reserved.

Part List





90ETLK 1985 / ELECTRIC PARTS 1

REF - NO	PART NUMBER	PART NAME	QUANTITY	REMARKS
1	688-85542-03-94	BRACKET	1	
2	90480-15064-00	GROMMET	3	
3	90387-06M03-00	COLLAR	3	
4	90119-06M26-00	BOLT, WITH WASHER	3	
5	688-85540-15-00	CDI UNIT ASSEMBLY	1	
6	688-85537-12-00	.COVER	1	
7	6E5-85547-10-00	.DAMPER	1	
8	98580-05010-00	.SCREW, PAN HEAD	4	
9	92990-05600-00	.WASHER, PLATE	4	
10	98580-04008-00	.SCREW, PAN HEAD	16	
11	92990-04200-00	.WASHER	16	
12	97395-06025-00	BOLT	2	
13	92990-06600-00	WASHER, PLATE	2	
14	90480-06157-00	GROMMET	1	
15	697-85570-10-00	IGNITION COIL ASSEMBLY	3	
16	97313-06030-00	BOLT	6	
17	92995-06100-00	WASHER, SPRING	6	
18	663-82370-01-00	PLUG CAP ASSY	3	
19	688-81960-61-00	RECTIFIER/REG ASSEMBLY (688-81960-60)	1	
20	97313-06020-00	BOLT, HEXAGON	2	
21	92990-06600-00	WASHER, PLATE	2	
22	688-81961-01-00	COVER	1	
23	98503-05025-00	SCREW, PAN HEAD	2	
24	92990-05600-00	WASHER, PLATE	2	
25	688-81940-11-00	STARTER SWITCH ASSEMBLY	1	
26	97395-06016-00	BOLT, HEX	1	
27	92990-06600-00	WASHER, PLATE	1	
28	688-82150-01-00	FUSE HOLDER ASSEMBLY	1	
29	682-82151-00-00	.FUSE (12V-20A)	1	
30	90116-06M22-00	BOLT, STUD	1	
31	95380-06700-00	NUT	2	
32	92995-06100-00	WASHER, SPRING	1	
33	92990-06200-00	WASHER, PLAIN	2	
34	688-82590-11-00	WIRE HARNESS ASSEMBLY	1	
35	688-82105-02-00	BATTERY CABLE	1	
36	688-82531-01-00	WIRE, LEAD	1	
37	697-82519-00-00	WIRE, EARTH LEAD	1	
38	688-82594-00-00	CLAMP	1	
39	688-83354-00-00	WIRE, EARTH LEAD 1	1	
40	663-81922-00-00	GROMMET	1	
41	688-82560-10-00	THERMO SWITCH ASSY	1	
42	688-82588-01-00	PLATE	1	
43	688-81950-10-00	RELAY ASSY	2	
44	97313-06020-00	BOLT, HEXAGON	1	
45	92990-06600-00	WASHER, PLATE	1	
46	688-81949-00-00	WIRE, LEAD	1	
47	688-85515-00-00	LEAD WIRE ASSEMBLY	1	

Part Notes

90ETLK 1985 / ELECTRIC PARTS 1

PART NUMBER	NOTE TEXT
92990-06600-00	OEM: This part number is among the Top 100 Most Popular Marine Maintenance Parts as of March 2014.

		
92990-06600-00		OEM: This part number is among the Top 100 Most Popular Marine Maintenance Parts as of March 2014.
92990-06600-00		OEM: This part number is among the Top 100 Most Popular Marine Maintenance Parts as of March 2014.
92990-06600-00		OEM: This part number is among the Top 100 Most Popular Marine Maintenance Parts as of March 2014.

©2014 Yamaha Motor Corporation, U.S.A. All rights reserved.

90ETLK 1985 / OIL PUMP

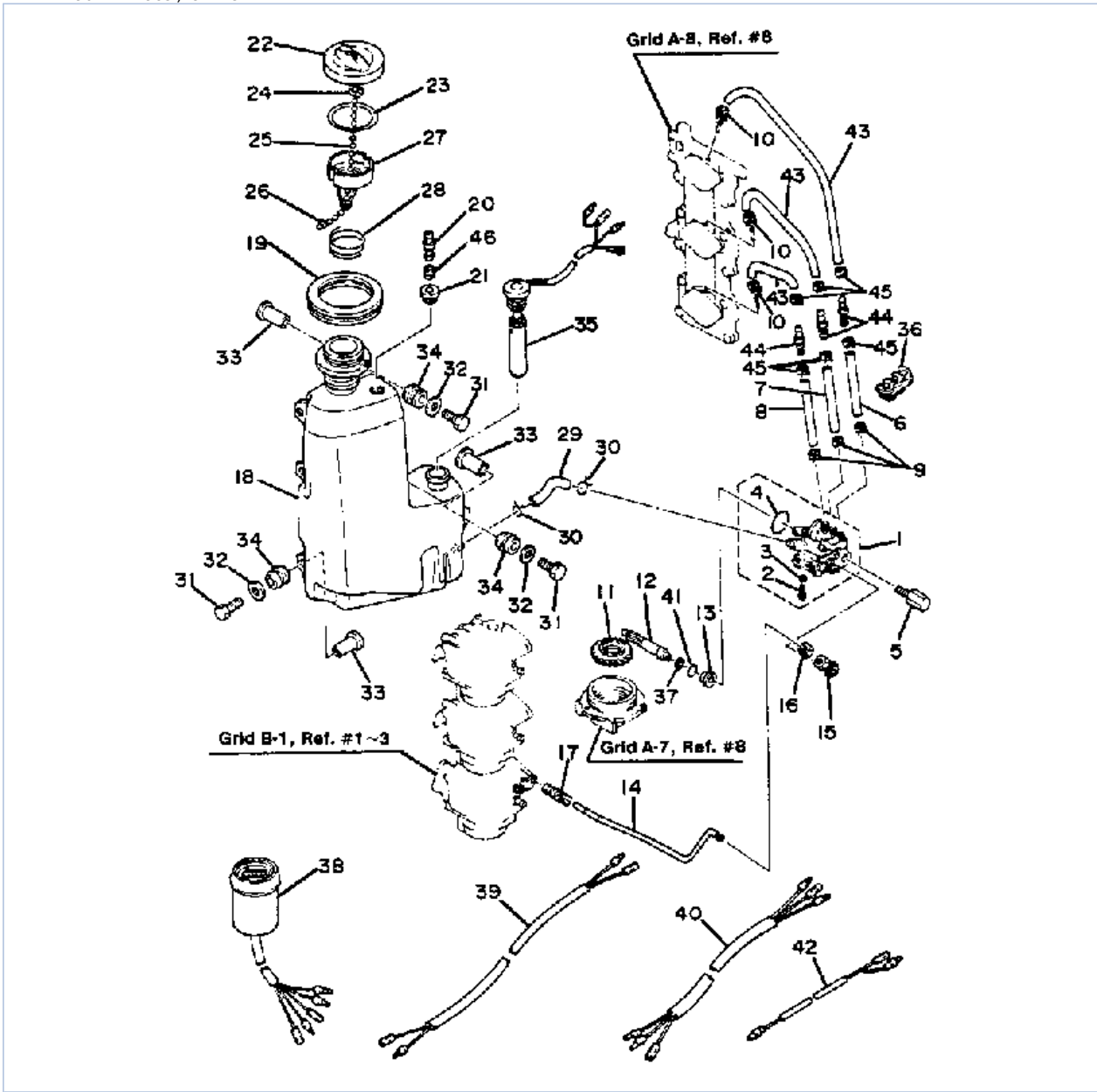

©2014 Yamaha Motor Corporation, U.S.A. All rights reserved.

Part List

90ETLK 1985 / OIL PUMP

REF - NO	PART NUMBER	PART NAME	QUANTITY	REMARKS
1	6H1-13200-01-00	OIL PUMP ASSEMBLY	1	
2	6E5-13471-01-00	.PLUG, DRAIN	1	
3	6E5-13475-00-00	.GASKET	1	
4	6E5-14562-00-00	.O-RING	1	
5	90109-06M22-00	BOLT	2	
6	90445-07M90-00	HOSE (L390)	1	
7	90445-07M89-00	HOSE (L310)	1	
8	90445-07M72-00	HOSE (L250)	1	
9	90468-07M02-00	CLIP	3	
10	90468-07M02-00	CLIP	3	
11	6H1-11536-00-00	GEAR, DRIVE	1	
12	6H1-11537-01-00	GEAR, DRIVEN	1	
13	6H1-13117-01-00	COLLAR, DISTANCE	1	
14	6H1-41241-00-00	ROD 1	1	
15	6H1-41237-00-00	JOINT, LINK	1	
16	95380-05600-00	NUT	1	
17	6R5-41237-00-00	JOINT, LINK	1	
18	6H1-21707-01-00	OIL TANK	1	
19	6H1-21735-00-00	SEAL 2	1	
20	6H1-21744-00-00	BREATHER	1	
21	90480-11M36-00	GROMMET	1	
22	99999-01505-00	CAP BODY & GSK.	1	
22	6H1-21771-01-00	.BODY CAP	1	
23	6H1-21771-01-00	.BODY CAP	1	
23	99999-01505-00	CAP BODY & GSK.	1	
24	6H1-24634-00-00	HOOK, CHAIN BALL	1	
25	6H1-24633-00-00	CHAIN, BALL	1	
26	6H1-21757-00-00	WASHER, SPECIAL 1	1	
27	6H1-24251-01-00	STRAINER 1	1	
28	90501-14M45-00	SPRING, COMPRESSION	1	
29	6H1-21766-01-00	PIPE, OIL	1	
30	90467-08004-00	CLIP	2	
31	97313-06025-00	BOLT	5	
32	90201-06050-00	WASHER, PLATE	5	
33	624-42542-00-00	PIPE	5	
34	6A0-82317-00-00	DAMPER, IGNITION COIL	5	
35	6H1-85720-10-00	OIL LVL GAUGE ASSEMBLY	1	
36	90464-07M05-00	CLAMP	1	
37	90201-08M93-00	WASHER, PLATE	1	
38	6H1-84301-00-00	OIL INDICATOR 2"	1	
39	6H1-81971-00-00	WIRE, LEAD	1	
40	6H1-84348-00-00	WIRE, LEAD 1	1	
41	93210-13595-00	O-RING	1	
42	6H1-81315-00-00	LEAD WIRE ASSEMBLY	1	
43	90445-07M87-00	HOSE (L110)	3	
44	6E5-13132-00-00	JOINT	3	
45	90468-07M02-00	CLIP	6	
46	90480-04M37-00	GROMMET	1	

Part Notes

90ETLK 1985 / OIL PUMP

PART NUMBER	NOTE TEXT
6H1-41237-00-00	OEM: This part number is among the Top 100 Most Popular Marine Maintenance Parts as of March 2014.



©2014 Yamaha Motor Corporation, U.S.A. All rights reserved.

90ETLK 1985 / STEERING GUIDE ATTACHMENT

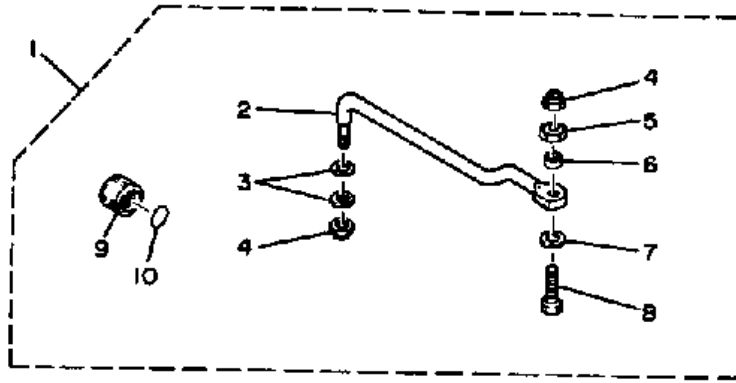

©2014 Yamaha Motor Corporation, U.S.A. All rights reserved.

Part List

90ETLK 1985 / STEERING GUIDE ATTACHMENT

REF - NO	PART NUMBER	PART NAME	QUANTITY	REMARKS
1	688-61350-10-00	STEERING GUIDE ATTACHMENT KIT	1	
2	688-61351-10-00	.ROD, STEERING LINK	1	
3	90201-10M20-00	.WASHER, PLATE	2	
4	90185-09M01-00	.NUT, SELF-LOCKING	2	
5	90170-09M03-00	.NUT	1	
6	90387-10M42-00	.COLLAR	1	
7	90201-10M63-00	.WASHER, PLATE	1	
8	6E5-61355-00-00	.BOLT	1	
9	6E5-43145-00-00	.CAP, CLAMP BRACKET	1	
10	93210-16275-00	.O-RING	1	

90ETLK 1985 / POWER TRIM TILT ASSY (- 453823)

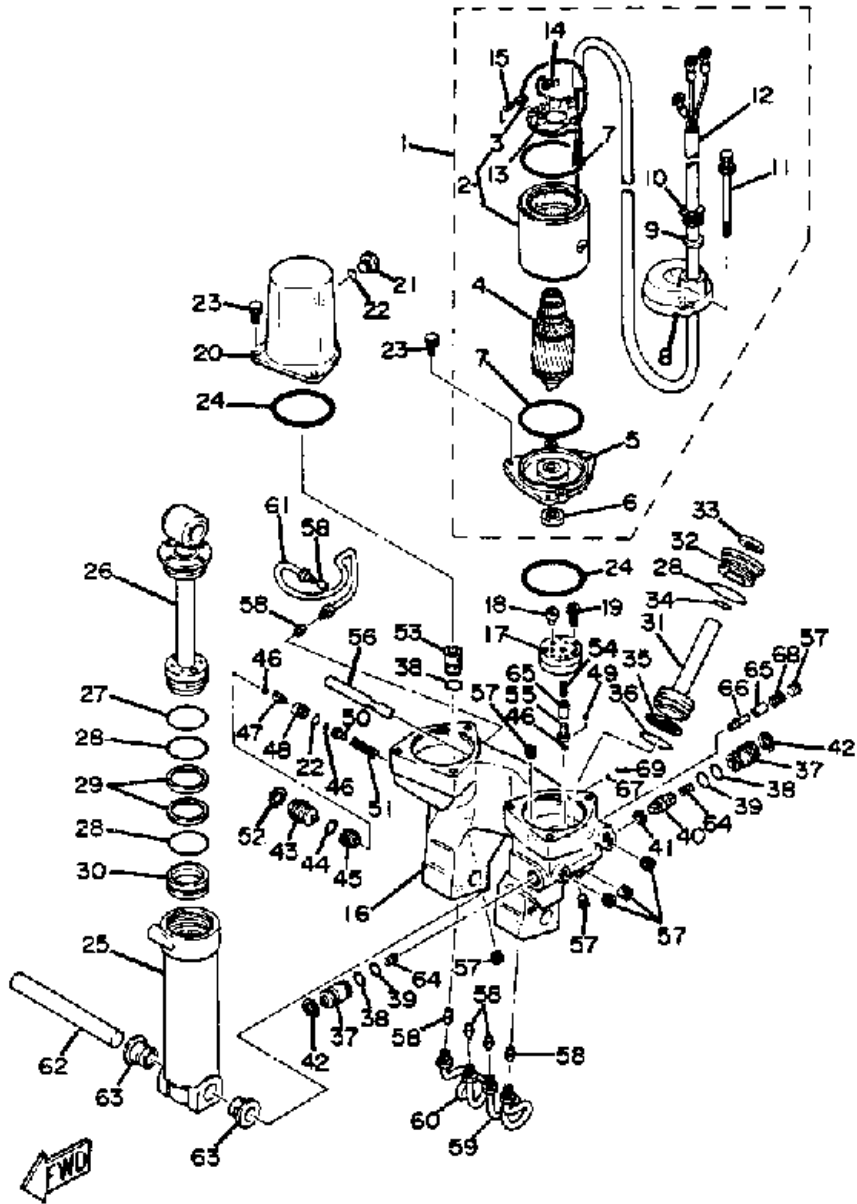

©2014 Yamaha Motor Corporation, U.S.A. All rights reserved.

Part List

90ETLK 1985 / POWER TRIM TILT ASSY (- 453823)

REF - NO	PART NUMBER	PART NAME	QUANTITY	REMARKS
1	688-43880-10-00	.MOTOR ASSEMBLY	1	
2	688-43804-01-00	..STATOR ASSEMBLY	1	
3	688-43891-01-00	..BRUSH 1	1	
4	(688-43805-01-00)	ARMATURE ASSY	1	
5	688-43881-01-00	..FRAME, END	1	
6	688-43882-00-00	..OIL SEAL	1	
7	688-43883-00-00	..O-RING	2	
8	688-43884-02-00	..FRAME, COMMUTATOR	1	
9	688-43885-01-00	..GROMMET	1	
10	688-43886-02-00	..BOLT	1	
11	688-43887-01-00	..BOLT	2	
12	688-43807-10-00	..WIRE SUB ASSEMBLY	1	
13	688-43806-01-00	..BRUSH HOLDER ASSEMBLY	1	
14	688-43891-01-00	..BRUSH 1	1	
15	90501-05M46-00	..SPRING, COMPRESSION	1	
16	6E5-43825-01-00	.HOUSING, TRIM&TILT	1	
17	688-43830-00-00	.GEAR PUMP ASSEMBLY	1	
18	688-43831-00-00	.CONNECTOR, SHAFT	1	
19	688-43878-00-00	.BOLT, SOCKET	3	
20	688-43828-00-00	.BODY, RESERVOIR	1	
21	688-43829-01-00	.PLUG, RESERVOR	1	
21	6H1-43800-00-EK	POWER TRIM TILT ASSY	1	
22	688-43869-00-00	.O-RING	2	
23	688-43879-00-00	.SCREW, W/WASHER	6	
24	688-43867-00-00	.O-RING	2	
25	6E5-43813-00-00	.CYLINDER, TILT	1	
26	688-43810-01-00	.PISTON SUB ASSEMBLY (TILT)	1	
27	688-43863-00-00	.O-RING	1	
28	688-43862-00-00	.O-RING	4	
29	688-43872-00-00	.RING, BACK UP	2	
30	6E5-43814-00-00	.PISTON, FREE	1	
31	6E5-43820-01-00	.PISTON SUB ASSEMBLY	2	
32	6E5-43821-00-00	.SCREW, TRIM CYLINDEREND	2	
33	6E5-43822-00-00	.SEAL, TRIM DUST	2	
34	93210-16275-00	.O-RING	2	
35	6E5-43874-00-00	.RING, BACK-UP	2	
36	93210-33M41-00	.O-RING	2	
37	688-43802-01-00	.VALVE SUB ASSEMBLY (MAIN)	2	
38	688-43864-00-00	.O-RING	3	
39	688-43865-00-00	.O-RING	2	
40	6E5-43841-00-00	.PISTON, SHUTTLE	1	
41	688-43873-00-00	.RING, BACK UP	1	
42	688-43876-00-00	.RING, SNAP	2	
43	688-43845-00-00	.SCREW, MANUAL REL	1	
44	688-43866-00-00	.O-RING	1	
45	688-43846-00-00	.SCREW, MANUAL VALVE	1	
46	688-43858-00-00	.BALL 1	3	
47	688-43848-00-00	.ROD, MANUAL RELEASE	1	
48	688-43847-00-00	.SEAT, MANUAL VALVE	1	
49	688-43868-00-00	.O-RING	1	
50	6E5-43849-00-00	.PIN, VALVE SUPPORT	1	
51	6E5-43854-00-00	.SRG, MANUAL RELEASE	1	

51	688-43835-09-00	.PIPE	1	
52	688-43875-00-00	.RING, SNAP	1	
53	6E5-43850-00-00	.VALVE SUB-ASSEMBLY (UPPER RELIEF)	1	
54	688-43856-02-00	.SPRING, DOWN RELIEF	1	
55	6E5-43844-01-00	.PIN, VLVSUPPORTK	1	
56	(688-43838-00-00)	PIPE, INTAKE	1	
57	688-43826-00-00	.PLUG, TAPER SCREW	7	
58	688-43832-00-00	.SEAT, UNION	6	
59	6E5-43833-00-00	.PIPE	1	
60	6E5-43834-00-00	.PIPE	1	
62	6E5-43818-00-00	.PIN, LOWER SHOCK MOUNT	1	
63	90386-18M14-00	.BUSH	2	
64	6E5-43894-00-00	.SPRING, SHUTTLE RETURN	2	
65	6E5-43898-00-00	.COLLAR, TENSION	2	
66	6E5-43823-00-00	.CHECK VALVE ASSEMBLY	1	
67	6E5-43877-00-00	.BALL	1	
68	6E5-43824-00-00	.SPRING	1	
69	6E5-43827-00-00	.RING SET	1	

90ETLK 1985 / POWER TRIM TILT ASSY (453824 -)

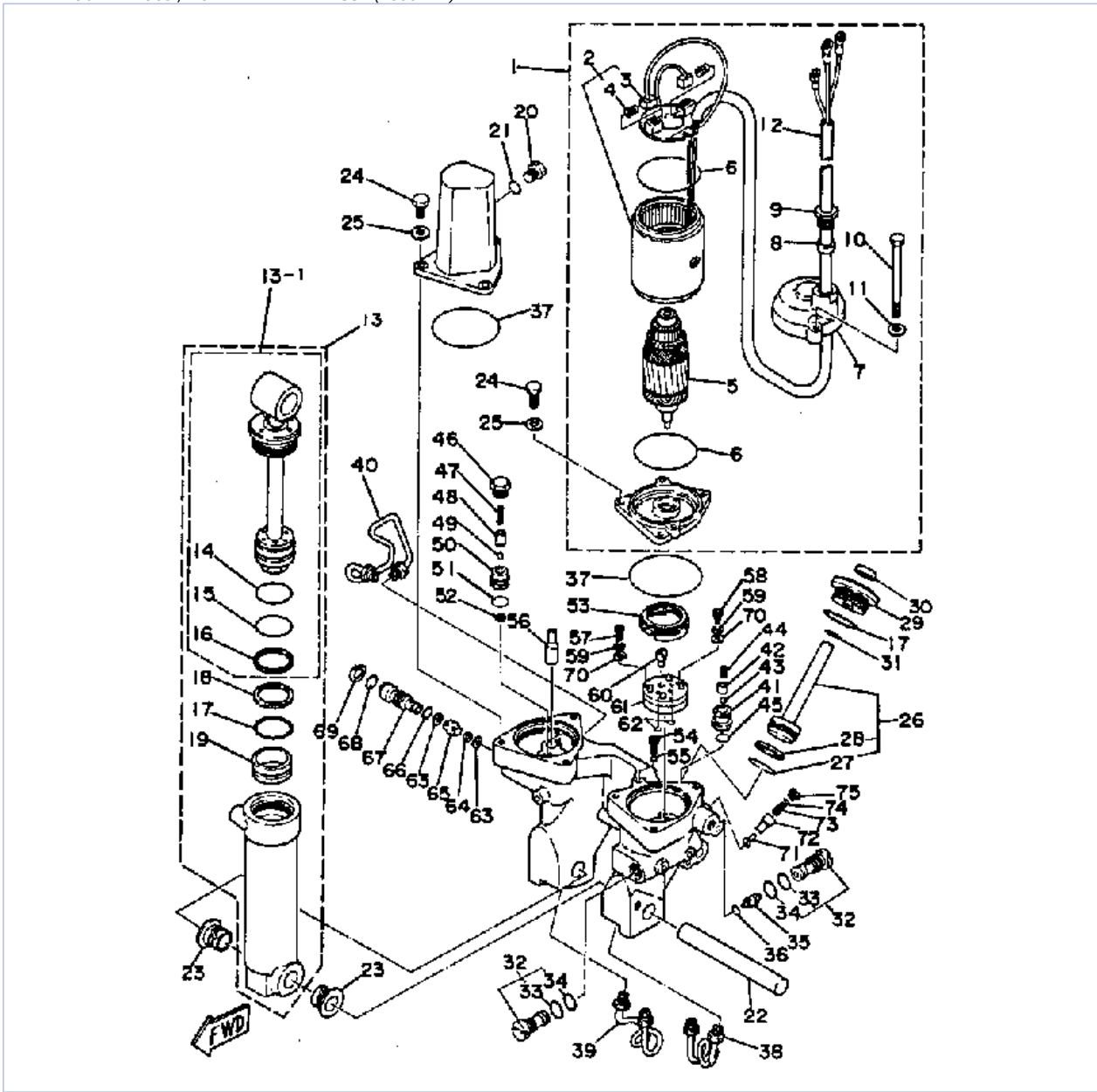

©2014 Yamaha Motor Corporation, U.S.A. All rights reserved.

Part List

90ETLK 1985 / POWER TRIM TILT ASSY (453824 -)

REF - NO	PART NUMBER	PART NAME	QUANTITY	REMARKS
1	688-43880-11-00	.MOTOR ASSEMBLY	1	
1	688-43810-02-00	..PISTON SUB ASSEMBLY (TILT)	1	
2	6E5-43804-00-00	..STATOR ASSEMBLY	1	
3	6E5-43891-00-00	..BRUSH 1	2	
4	90501-05M54-00	..SPRING	2	
5	6E5-43805-00-00	..ARMATURE ASSEMBLY	1	
6	93210-71M76-00	..O-RING	2	
7	6E5-43884-00-00	..FRAME, COMMUTATOR END	1	
8	6E5-43885-00-00	..GROMMET	1	
9	6E5-43886-00-00	..BOLT	1	
10	6E5-43887-00-00	..BOLT	2	
11	90201-05M01-00	..WASHER	2	
12	688-43807-11-00	..WIRE SUB ASSEMBLY	1	
13	688-4380E-00-00	.TILT CYLINDERASSEMBLY (86)	1	
14	6E5-43861-00-00	..O-RING	1	
15	6E5-43862-00-00	..O-RING	1	
16	6E5-43872-00-00	..RING, BACK UP	1	
17	6E5-43862-00-00	..O-RING	3	
18	6E5-43872-00-00	..RING, BACK UP	1	
19	6E5-43814-01-00	..PISTON, FREE	1	
20	6E5-43829-00-00	.PLUG, RESERVOIR	1	
21	6E5-43863-00-00	.O-RING	1	
22	6E5-43818-00-00	.PIN, LOWER SHOCK MOUNT	1	
23	90386-18M14-00	.BUSH	2	
24	(90101-06M85-00)	BOLT	6	
25	90209-06M09-00	.WASHER	6	
26	6E5-43820-02-00	.PISTON SUB ASSEMBLY	2	
27	6E5-43864-00-00	..O-RING	2	
28	6E5-43874-01-00	..RING, BACK UP	2	
29	6E5-43821-01-00	.SCREW, TRIM CYLINDER END	2	
29	6E5-43834-01-00	.PIPE	1	
30	6E5-43822-01-00	.SEAL, TRIM DUST	2	
31	6E5-43865-00-00	.O-RING	2	
32	6E5-43802-00-00	.VALVE SUB ASSEMBLY	2	
33	6E5-43866-00-00	..O-RING	2	
34	6E5-43867-00-00	..O-RING	2	
35	6E5-43841-01-00	.PISTON, SHUTTLE	1	
36	6E5-43868-00-00	.O-RING	1	
37	6E5-43869-00-00	.O-RING	2	
38	6E5-43833-01-00	.PIPE	1	
40	6E5-43835-01-00	.PIPE	1	
41	6E5-43851-01-00	.SEAT, RELIEF VALVE	1	
42	6E5-43844-02-00	.PIN, VALVE SUPPORT	1	
43	6E5-43858-00-00	.BALL	1	
44	6E5-43856-00-00	.SPRING, DOWN RELIEF	1	
45	6E5-43883-00-00	.O-RING	1	
46	6E5-43843-00-00	.SCREW, VALVE LOCK	1	
47	6E5-43855-00-00	.SPRING, UP RELIEF	1	
48	6E5-43859-00-00	.PIN, VALVE SUPPORT	1	
49	6E5-43877-01-00	.BALL	1	
50	6E5-43895-00-00	.O-RING	1	

51	6E5-43896-00-00	.O-RING	1	
52	6E5-43816-10-00	.FILTER 1	1	
53	6E5-43817-10-00	.FILTER 2	1	
54	90109-06M21-00	.BOLT	1	
55	6E5-43897-00-00	.O-RING	1	
56	6E5-43880-00-0	.UNAVAILABLE IN PRICE BOOK	1	
57	6E5-43878-01-00	.BOLT, SOCKET	2	
58	6E5-43888-01-00	.BOLT, SOCKET	1	
59	90209-05M10-00	.WASHER	3	
60	6E5-43831-00-00	.CONNECTOR, SHAFT	1	
61	6E5-43830-00-00	.GEAR PUMP ASSEMBLY	1	
62	93210-07M78-00	.O-RING	2	
63	6E5-43847-00-00	.SEAT, MANUAL VALVE	2	
64	6E5-43854-01-00	.SPRING, MANUAL RELEASE	1	
65	6E5-4382A-00-00	.ADAPTER 1	1	
66	93210-10M74-00	.O-RING	1	
67	6E5-43845-01-00	.SCREW, MANUAL RELEASE	1	
68	93210-18M75-00	.O-RING	1	
69	6E5-43838-00-00	PIPE, INTAKE	1	
69	6H1-43875-00-00	.RING, SNAP	1	
70	90201-05M00-00	.WASHER, PLATE	3	
71	6E5-4381A-00-00	.SHAFT	1	
72	6E5-43849-01-00	.PIN, VALVE SUPPORT	1	
73	6E5-43824-01-00	.SPRING, COMPRESSION	1	
74	93210-06M77-00	.O-RING	1	
75	6E5-43842-00-00	.SCREW, VALVE SEAT	1	

90ETLK 1985 / REPAIR KIT

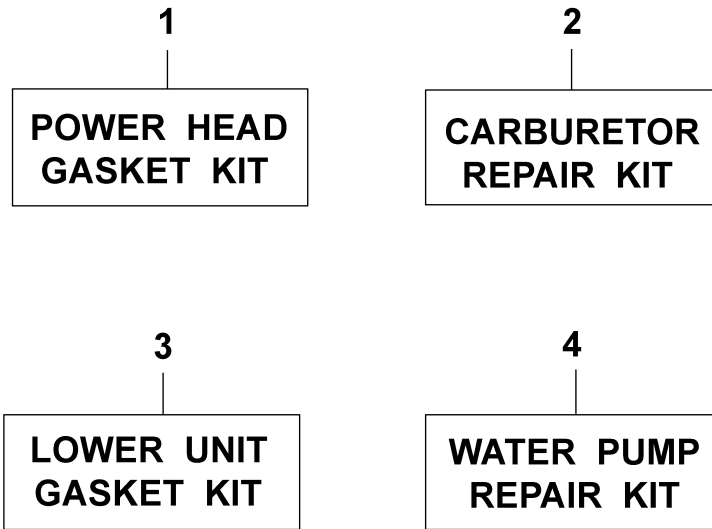

©2014 Yamaha Motor Corporation, U.S.A. All rights reserved.

Part List

90ETLK 1985 / REPAIR KIT

REF - NO	PART NUMBER	PART NAME	QUANTITY	REMARKS
1	6H1-W0001-00-00	POWER HEAD GASKET KIT	1	
2	6H1-W0093-01-00	CARBURETOR REPAIR KIT	1	
3	688-W0001-20-00	LOWER UNIT GASKET KIT	1	
4	692-W0078-00-00	WATER PUMP REPAIR KIT	1	

©2014 Yamaha Motor Corporation, U.S.A. All rights reserved.