

V8-380-CE-A

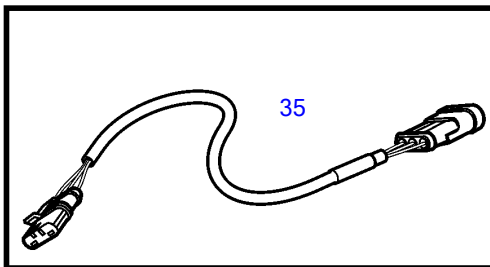
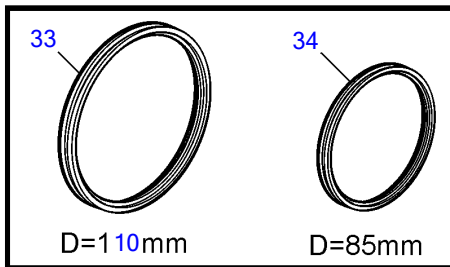
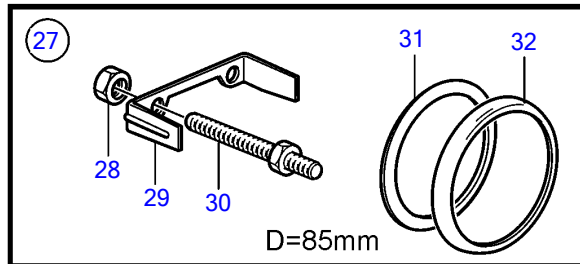
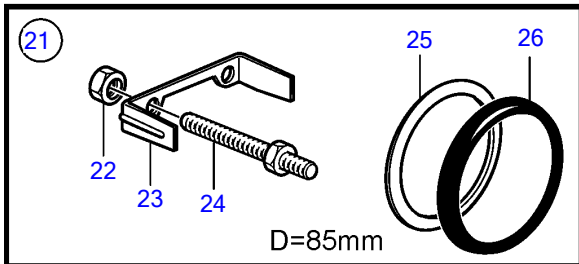
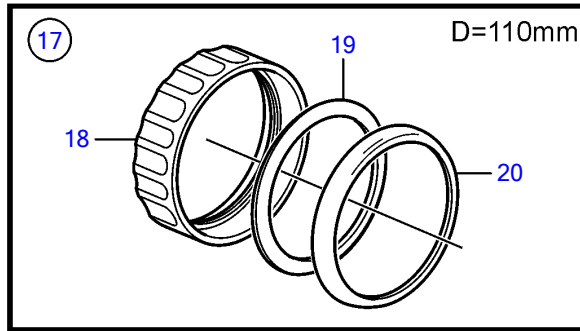
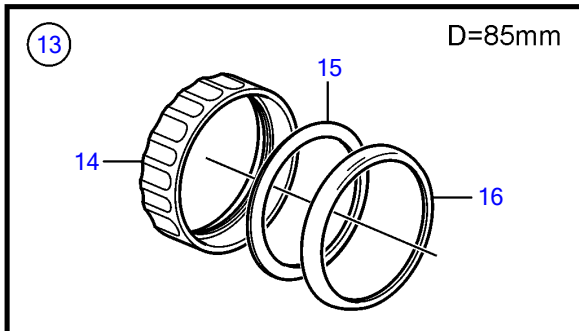
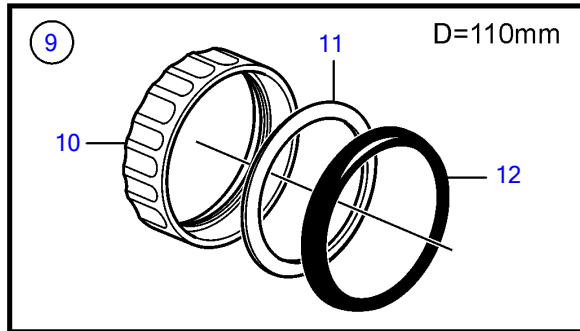
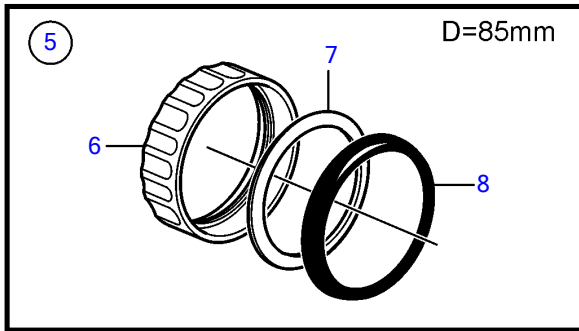
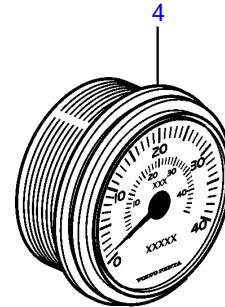
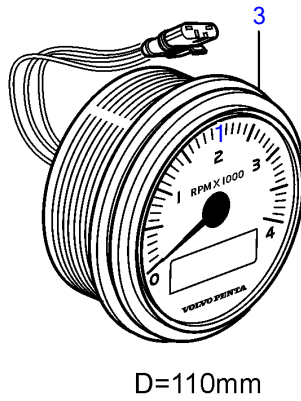
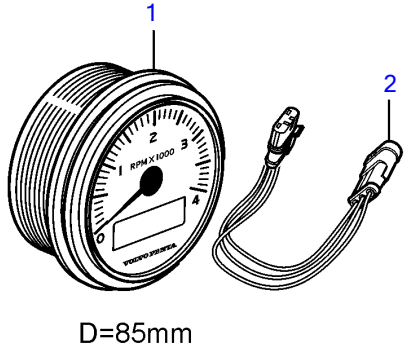

V8-380-CE-A

REF	PART NO.	QTY	DESCRIPTION	SEE SEC.	NOTES
1	21509646	1	Tachometer		6000 rpm, Black, replaced by next part number
	21628158	1	Tachometer		6000 rpm, Black
	21509644	1	Tachometer		6000 rpm, White, replaced by next part number
	21628157	1	Tachometer		6000 rpm, White
2	3884843	1	• Wiring harness		
3	21234545	1	Tachometer kit		6000 rpm, Black
	21511183	1	Tachometer kit		6000 rpm, Black
	21234544	1	Tachometer kit		6000 rpm, White, replaced by next part number
	21511180	1	Tachometer kit		
4	874930	1	Speedometer		White 0-40 Knots, 0-45 mph
	874917	1	Speedometer		Black 0-40 knots, 0-45 mph
	881650	1	Speedometer		White 0-60 Knots, 0-70 mph
	881645	1	Speedometer		Black 0-60 knots, 0-70 mph
	3807508	1	Speedometer		Black, 0-45 mph
	3807510	1	Speedometer		Black, 0-70 mph
	3807513	1	Speedometer		White, 0-70 mph
	21265104	1	Speedometer		Unit neutral, D=110mm, Black 0-60 knots
5	874708	1	Mounting kit		Black
6	874449	1	• Attaching ring		
7	874706	1	• Gasket		
8	874447	1	• Ring		
9	3847888	1	Mounting kit		Black
			• Bulletin P-36-9-3	P-36-9-3-EN	New products in the EVC family
10	(3884098)	1	• Attaching ring		Obsolete part
11	3884103	1	• Gasket		
12	3847887	1	• Ring		
13	874732	1	Mounting kit		Chrome
14	874449	1	• Attaching ring		
15	874706	1	• Gasket		
16	874730	1	• Ring		
17	3885216	1	Mounting kit		Chrome
			• Bulletin P-36-9-3	P-36-9-3-EN	New products in the EVC family
18	(3884098)	1	• Attaching ring		Obsolete part
19	3884103	1	• Gasket		
20	3884096	1	• Ring		
21	881612	1	Brace kit		Black
22	881610	2	• Nut		
23	881608	1	• Brace		
24	881609	2	• Stud		
25	874706	1	• Gasket		
26	874447	1	• Ring		
27	881614	1	Brace kit		Chrome
28	881610	2	• Nut		
29	881608	1	• Brace		
30	881609	2	• Stud		
31	874706	1	• Gasket		
32	874730	1	• Ring		
33	3886791	1	X-ring		For flush mounting.
			• Bulletin P-36-9-3	P-36-9-3-EN	New products in the EVC family
34	874844	1	X-ring		For flush mounting.
35	874759	1	Extension cable\verl		L=1000mm
	3807043	1	Extension cable\verl		L=3000mm