

DP-TRANSOM SHIELD WITH MOUNTING COMPONENTS

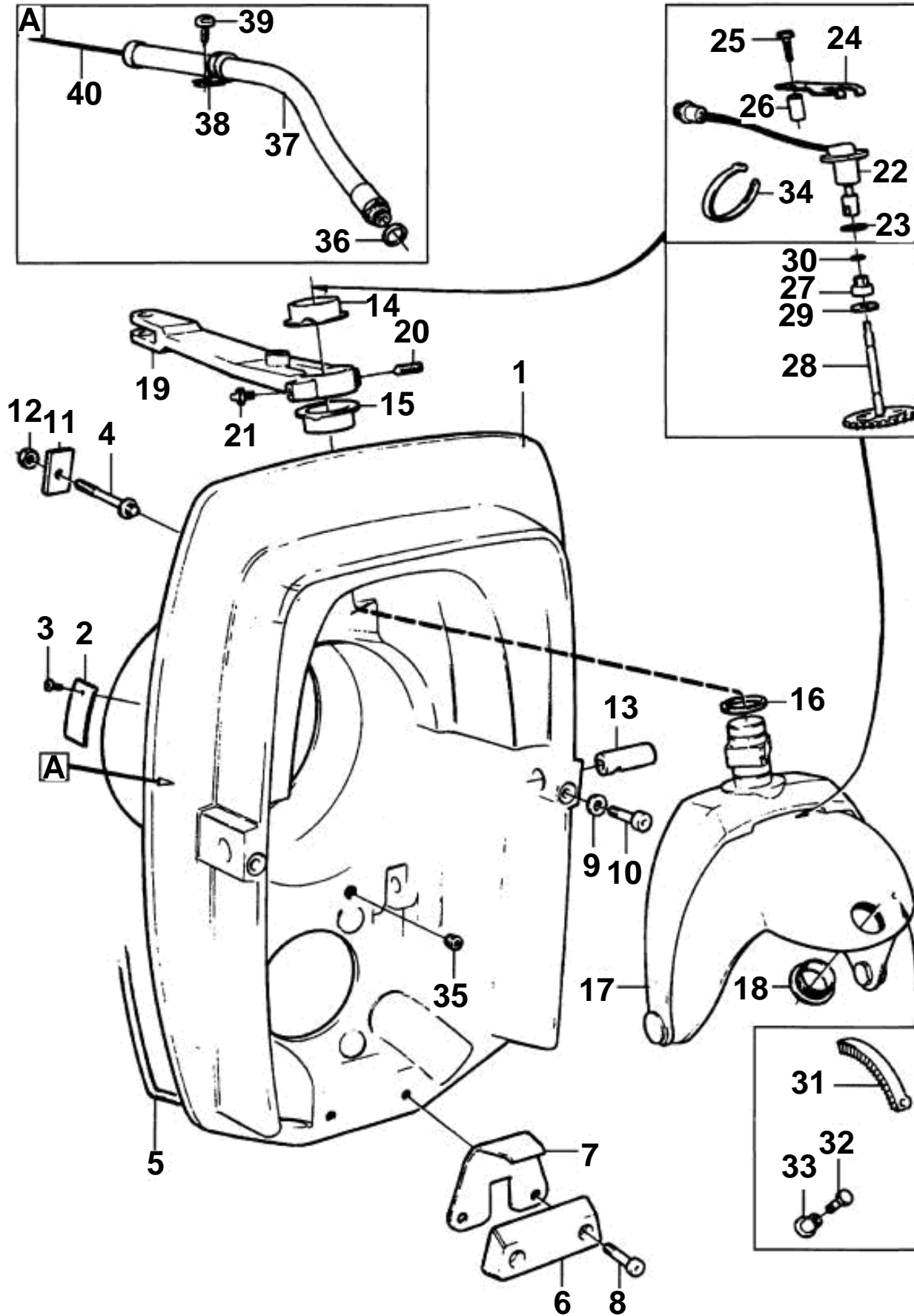

DP-TRANSOM SHIELD WITH MOUNTING COMPONENTS

REF	PART NO.	QTY	DESCRIPTION
1	876630	1	Shield
2	853706	1	· Type plate
3	804269	2	· Drive screw
4	853595	6	Stud
5	852868	X	Sealing strip, L=1750 mm
6	852835	1	Zinc electrode
7	872963	1	Support plate
8	946541	2	Screw
9	941670	2	Washer
10	963699	2	Screw
11	852866	6	Washer
12	963108	6	Nut
13	872493	2	Pin
14	854705	1	Bushing
15	854704	1	Bushing
16	977313	1	Sealing ring
17	872845	1	Steering fork kit
18	853048	1	· Bushing
19	872722	1	Spindle arm
20	947904	1	Set screw
21	3850675	1	Nipple
22	828726	1	Potentiometer
23	955991	1	O-ring
24	853039	1	Bracket
25	955298	1	Screw
26	872355	1	Spacer sleeve
27	851430	1	Bushing
28	852984	1	Drive gear
29	966207	1	Sealing ring
30	925050	1	O-ring
31	872812	1	Gear segment
32	853759	1	Screw
33	853760	1	Rivet nut
34	948210	1	Strip clamp
35	853215	2	Plug
36	897745	1	Gasket
37	839091	1	Hose
38	952635	1	Clamp
39	955512	1	Screw
40		X	CONTROL CABLE