

1

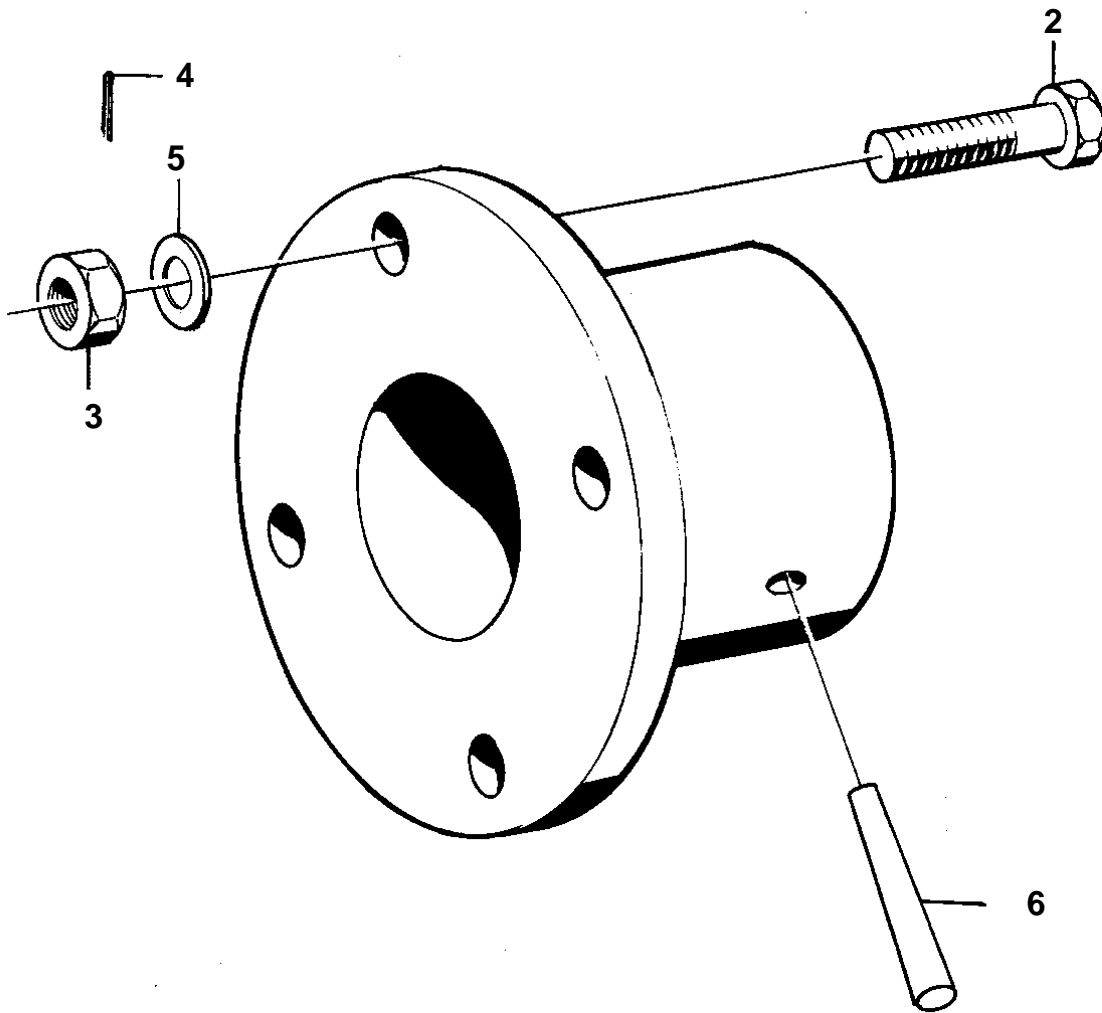

4624

BB231A, BB261A

REF	PART NO.	QTY	DESCRIPTION	NOTES
1	829281	1	Companion flange	40MM HOLE FOR PROPELLER SHAFT.
2	955692	4	· Screw	L = 32 MM
	955691	4	· Screw	L = 25 MM
3	955883	4	· Nut	
4	907834	4	· Cotter pin	
5	941909	4	· Spring washer	
6	907617	1	· Pin	