

AQ290A

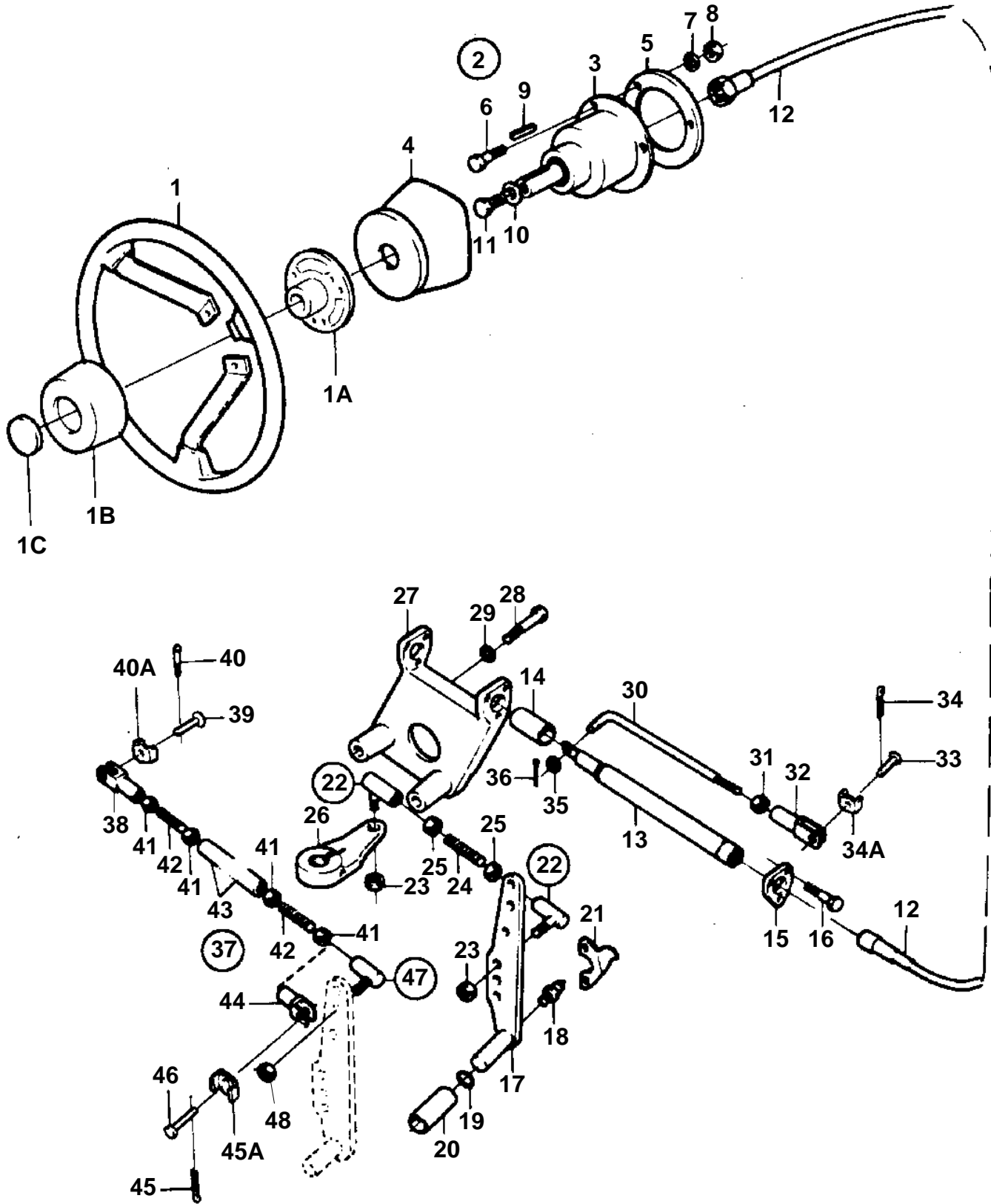

AQ290A

REF	PART NO.	QTY	DESCRIPTION	NOTES
1	850936	1	Steering wheel	
1A	850937	1	• Steering wheel hub	
1B	828943	1	• Steering wheel pad	
1C	850938	1	• Steering wh emblem	
2	851056	1	Steering head	
3		1	• STEERING GEAR	
4	851057	1	• Cover	
5	851069	1	• Washer	
6	940101	3	• Screw	
7	955892	3	• Washer	
8	955781	3	• Nut	
9	851349	1	• Key	
10	948823	1	• Washer	
11	940148	1	• Screw	
12	852035	X	Steering cable	L = 800 MM
	851017	X	Steering cable	L = 2750 MM
	851018	X	Steering cable	L = 3000 MM
	851019	X	Steering cable	L = 3250 MM
	851020	X	Steering cable	L = 3500 MM
	851021	X	Steering cable	L = 3750 MM
	851022	X	Steering cable	L = 4000 MM
	851023	X	Steering cable	L = 4250 MM
	851024	X	Steering cable	L = 4500 MM
	851025	X	Steering cable	L = 4750 MM
	851026	X	Steering cable	L = 5000 MM
	851027	X	Steering cable	L = 5250 MM
	851028	X	Steering cable	L = 5500 MM
	851029	X	Steering cable	L = 5750 MM
	851030	X	Steering cable	L = 6000 MM
	851031	X	Steering cable	L = 6500 MM
	851032	X	Steering cable	L = 7000 MM
	851033	X	Steering cable	L = 7500 MM
	851034	X	Steering cable	L = 8000 MM
13	851059	1	Steering cylinder	FOR PORT MOUNTING.
	851147	1	Steering cylinder	FOR STARBOARD MOUNTING.
14	851094	1	• Sleeve	
15	850961	1	• Washer	
16	955286	3	• Screw	
17	851385	1	Link arm	(850480)
18	914169	1	Lubricating nipple	
19	955906	1	Washer	
20	850653	1	Bushing	SEE GROUP 4A
21	850489	1	Stop arm	
22	875772	2	Ball joint kit	
23	851326	2	• Lock nut	
24	850736	1	Control rod	
25	940152	2	Nut	
26	850488	1	Spindle arm	SEE GROUP 4A
27	850958	1	Guide bracket	
28	955541	2	Screw	
29	942336	2	Spring washer	
30	850478	1	Link rod	
31	940154	1	Nut	
32	956511	1	Fork	
33	913158	1	Clevis pin	
34	907856	1	Cotter pin	
35	940097	1	Washer	
36	964960	1	Cotter pin	
37	828913	1	Link stay	ONLY FOR TWIN INSTALLATION.. ADJUSTABLE BETWEEN 610-1000 MM
38	956511	1	• Fork	
39	913158	1	• Clevis pin	
40	907856	1	• Cotter pin	
41	940154	4	• Nut	

