

AQ225D

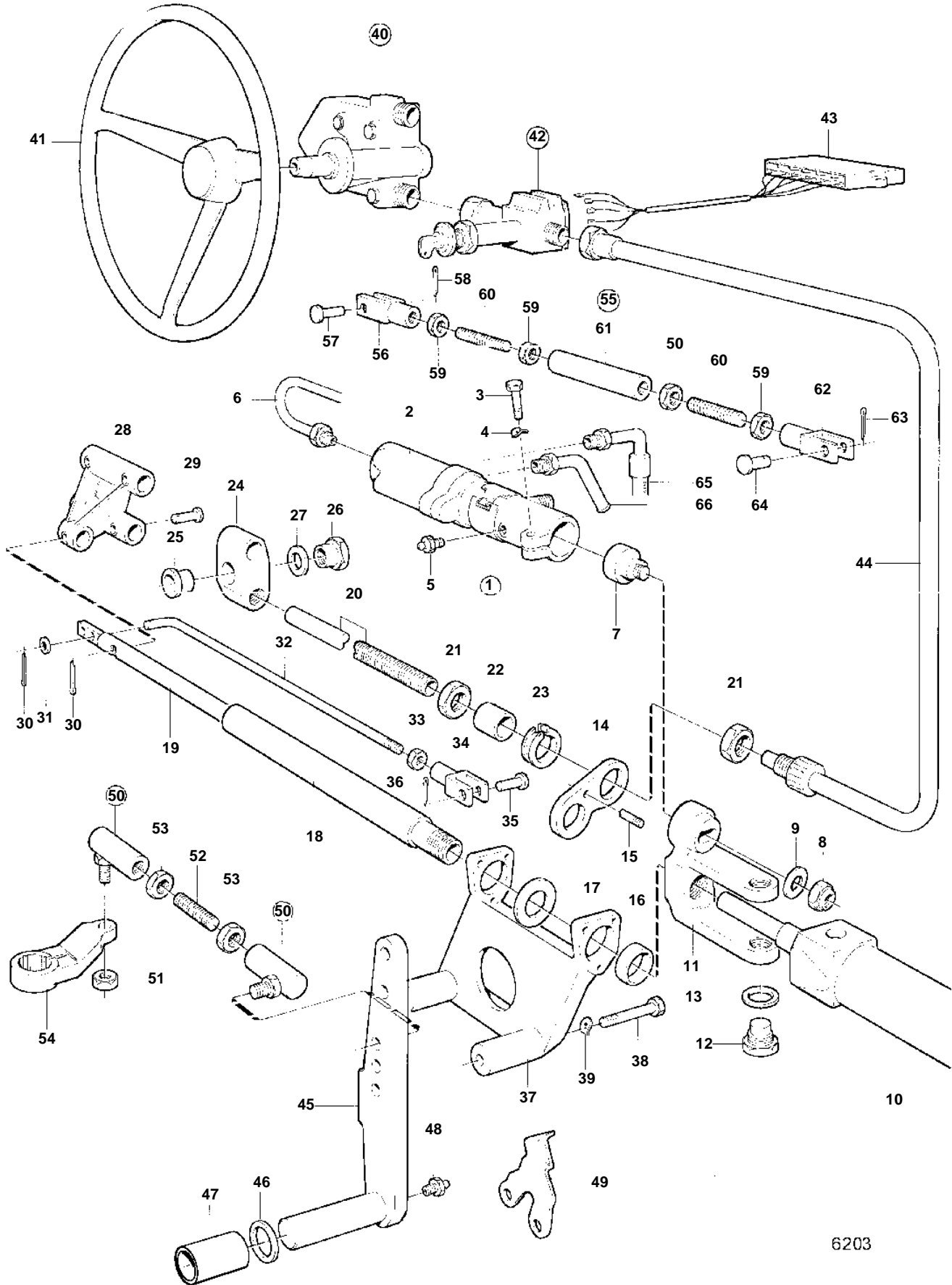

6203

AQ225D

REF	PART NO.	QTY	DESCRIPTION	SEE SEC.	NOTES
1		1	Cylinder		
2		1	• Servo valve	17301	
3	955535	1	• Hexagon screw		
4	942336	1	• Spring washer		
5		1			
6		1	• Oil pressure pipe		
		1	• Oil pressure pipe		
7		1	• Shoulder screw		
8	950386	1	• Lock nut		
9	955898	1	• Washer		
10		1	• Hydraulic cylinder		
11		1	• Bracket		
12		2	• Shoulder screw		
13	941912	2	• Spring washer		
14		1	• Guide		
15		1	• Guide pin		
16		1	• Bushing		
17	955904	1	• Washer		
18		1	• Tube		
19	851355	1	• Piston rod		
20	850771	1	• Anchorage		FOR FLY BRIDGE INSTALLATION USE 2PC ATTACHMENT PIPE FOR FLYING BRIDGE INSTALLATION USE 2PC ATTACHMENT PIPE 850771. AND 6EA NUT 850778. 850771, AND 6EA NUT 850778.
21	850778	2	• Nut		
22		1	• Guide tube		
23		1	• Guide bushing		
24		1	• Bracket		
25		1	• Bushing		
26		1	• Shoulder screw		
27	941914	1	• Spring washer		
28		1	• End piece		
29		3	• Clevis pin		
30	964960	5	• Split pin		
31	940097	1	Washer		
32		1	Link rod		
33	940154	1	Hexagon nut		
34	956511	1	Fork		
35	913158	1	Clevis pin		
36	907856	1	Split pin		
37		1	Guide bracket		
38	955541	2	Hexagon screw		
39	942336	2	Spring washer		
40	850809	1	Steering head		
				17304	
41	850936	1	Steering wheel		
42		1	Steering lock		
				17305	
43		1	Extension cable\verl		
44	853185	X	Steering cable		L = 3000 MM
	850811	X	Steering cable		L = 3300 MM
	853188	X	Steering cable		L = 3750 MM
	853189	X	Steering cable		L = 4000 MM
	853190	X	Steering cable		L = 4250mm
	850815	X	Steering cable		L = 4500 MM
	850816	X	Steering cable		L = 4800 MM
	853193	X	Steering cable		L = 5000 MM
	853194	X	Steering cable		L = 5500 MM
	853195	X	Steering cable		L = 6000mm
	828866	X	Steering cable		L = 6750mm
	853287	X	Steering cable		L = 8000 MM
	853288	X	Steering cable		L = 8500 MM
45		1	Link arm		
46	955906	1	Washer		

AQ225D

REF	PART NO.	QTY	DESCRIPTION	SEE SEC.	NOTES
47	850653	1	Bushing		SEE GROUP 4A
48	914169	1	Lubricating nipple		
49	850489	1	Stop arm		
50		2	Ball joint kit		
51	851326	2	• Nut		
52	850736	1	Control rod		
53	940152	2	Hexagon nut		
54	850488	1	Spindle arm		SEE GROUP 4A
55		1	Link stay		ONLY FOR TWIN INSTALLATION., ADJUSTABLE BETWEEN 610-970 MM.
56	956511	1	• Fork		
57	913158	1	• Clevis pin		
58	907856	1	• Split pin		
59	940154	4	• Hexagon nut		
60		2	• Rod		
61		1	• Tube		L = 560 MM
		1	• Tube		ONLY INCLUDED IN 850776., L = 360 MM
62	956511	1	• Fork		
63	907856	1	• Split pin		
64	913158	1	• Clevis pin		
65	851526	1	Pressure hose, HOSE		L = 1400 MM
				17301	
66		1	Hose coupling	17301	