

AQ225D

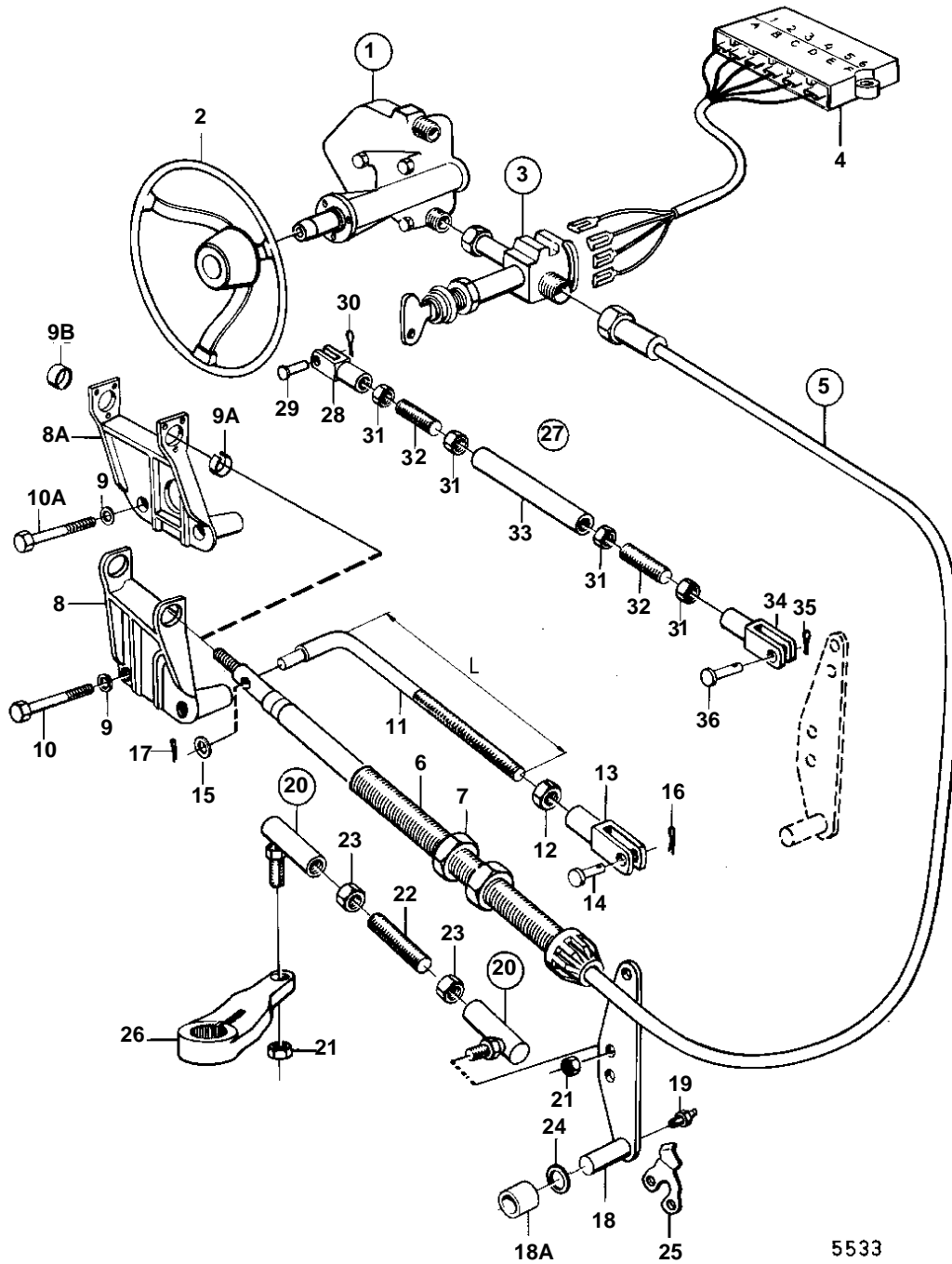

5533

AQ225D

REF	PART NO.	QTY	DESCRIPTION	SEE SEC.	NOTES
1	850809	1	Steering head		
				17304	
2	850936	1	Steering wheel		(814138)
3		1	Steering lock		
				17305	
4		1	Extension cable\verl		
5	853185	X	Steering cable		L = 3000 MM
	850811	X	Steering cable		L = 3300 MM
	853188	X	Steering cable		L = 3750 MM
	853189	X	Steering cable		L = 4000 MM
	853190	X	Steering cable		L = 4250mm
	850815	X	Steering cable		L = 4500 MM
	850816	X	Steering cable		L = 4800 MM
	853193	X	Steering cable		L = 5000 MM
	853194	X	Steering cable		L = 5500 MM
	853195	X	Steering cable		L = 6100 MM
	828866	X	Steering cable		L = 6750mm
	853287	X	Steering cable		L = 8000 MM
	853288	X	Steering cable		L = 8500 MM
6	850771	1	Anchorage		(835693)
7	850778	4	Nut		(955861)
8		1	BRACKET		REPLACED BY 1EA BRACKET 850958, 2EA BOLT 955541, 1EA BUSHING 850959, 1EA BUSHING 850960.
8A		1	Guide bracket		
9	942336	2	Spring washer		
9A		1	Bushing		
9B		1	Bushing		
10	955542	2	Hexagon screw		L = 83 MM
10A	955541	2	Hexagon screw		L = 76 MM
11		1	Link rod		L = 318 MM
		1	Link rod		L = 195 MM
12	940154	1	Hexagon nut		
13	956511	1	Fork		
14	913158	1	Clevis pin		
15	940097	1	Washer		
16	907856	1	Split pin		
17	964960	1	Split pin		
18		1	Link arm		(850480)
18A	850653	1	Bushing		SEE GROUP 4A
19	914169	1	Lubricating nipple		
20		2	Ball joint kit		
21	851326	2	• Nut		
22	850736	1	Control rod		
23	940152	2	Hexagon nut		
24	955906	1	Washer		
25	850489	1	Stop arm		
26	850488	1	Spindle arm		SEE GROUP 4A
27		1	Link stay		ONLY FOR TWIN INSTALLATION., ADJUSTABLE BETWEEN 610-970 MM.
28	956511	1	• Fork		
29	913158	1	• Clevis pin		
30	907856	1	• Split pin		
31	940154	4	• Hexagon nut		
32		2	• Rod		
33		1	• Tube		L = 560 MM
		1	• Tube		ONLY INCLUDED IN 850776., L = 360 MM
34	956511	1	• Fork		
35	907856	1	• Split pin		
36	913158	1	• Clevis pin		