

AQ225D

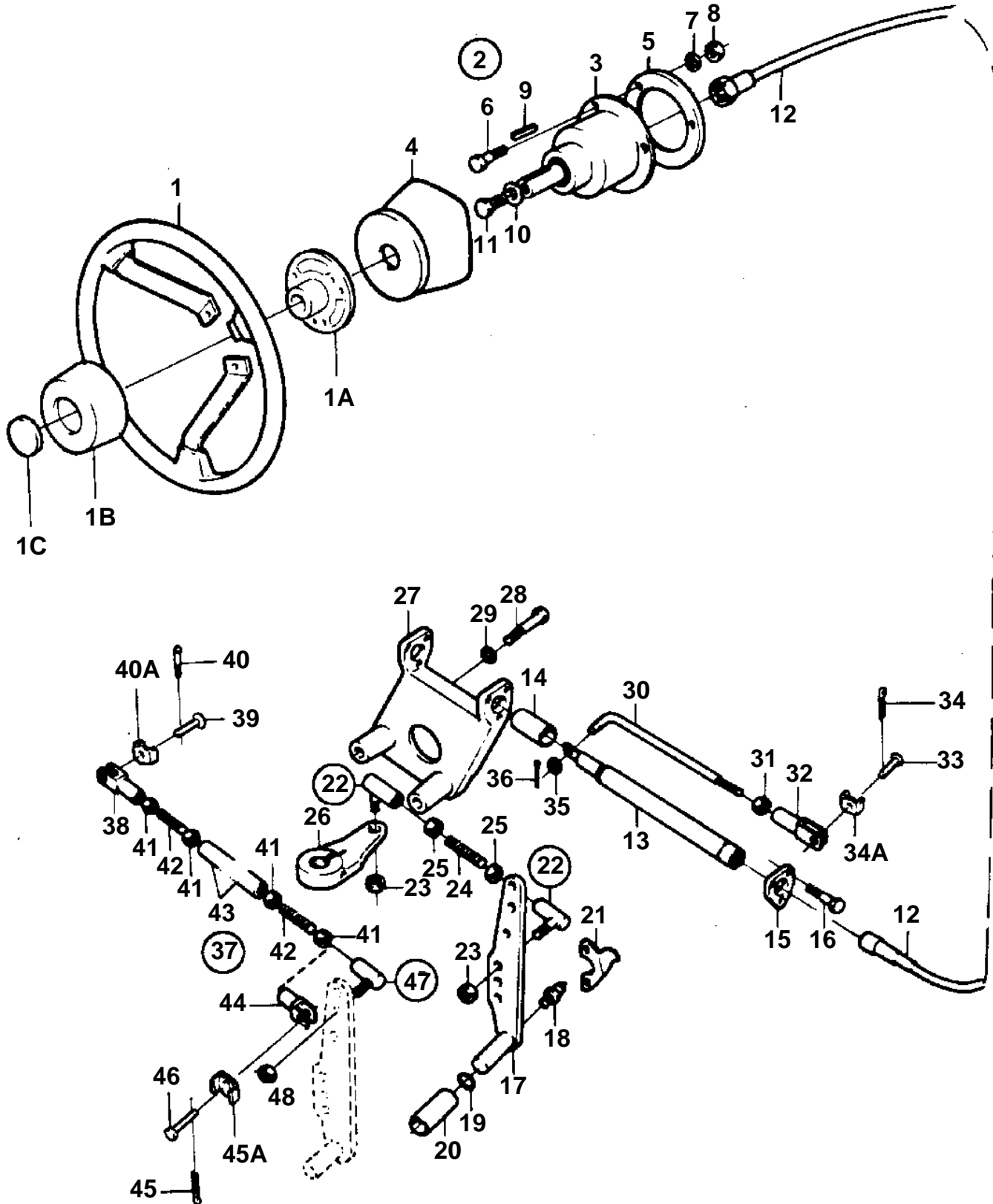

AQ225D

REF	PART NO.	QTY	DESCRIPTION	NOTES
1	850936	1	Steering wheel	
1A		1	• Steering wheel hub	
1B		1	• Steering wheel pad	
1C		1	• Emblem	
2		1	Steering gear	
3		1	• STEERING GEAR	
4		1	• Cover	
5		1	• Washer	
6	940101	3	• Hexagon screw	
7	955892	3	• Washer	
8	955781	3	• Hexagon nut	
9		1	• Key	
10		1	• Washer	
11	940148	1	• Hexagon screw	
12		X	Steering cable	L = 800 MM
		X	Steering cable	L = 2750mm
		X	Steering cable	L = 3000 MM
		X	Steering cable	L = 3250mm
		X	Steering cable	L = 3500mm
		X	Steering cable	L = 3750 MM
		X	Steering cable	L = 4000 MM
		X	Steering cable	L = 4250 MM
		X	Steering cable	L = 4500 MM
		X	Steering cable	L = 4750mm
		X	Steering cable	L = 5000 MM
		X	Steering cable	L = 5250mm
		X	Steering cable	L = 5500 MM
		X	Steering cable	L = 5750mm
		X	Steering cable	L = 6000 MM
		X	Steering cable	L = 6500mm
		X	Steering cable	L = 7000 MM
		X	Steering cable	L = 7500 MM
		X	Steering cable	L = 8000 MM
13		1	Steering cylinder	FOR PORT MOUNTING.
		1	Steering cylinder	FOR STARBOARD MOUNTING.
14		1	• Spacer sleeve	
15		1	• Washer	
16		3	• Hexagon screw	
17		1	Link arm	(850480)
18	914169	1	Lubricating nipple	
19	955906	1	Washer	
20	850653	1	Bushing	SEE GROUP 4A
21	850489	1	Stop arm	
22		2	Ball joint kit	
23	851326	2	• Nut	
24	850736	1	Control rod	
25	940152	2	Hexagon nut	
26	850488	1	Spindle arm	SEE GROUP 4A
27		1	Guide bracket	
28	955541	2	Hexagon screw	
29	942336	2	Spring washer	
30		1	Link rod	
31	940154	1	Hexagon nut	
32	956511	1	Fork	
33	913158	1	Clevis pin	
34	907856	1	Split pin	
35	940097	1	Washer	
36	964960	1	Split pin	
37		1	Link stay	ONLY FOR TWIN INSTALLATION., ADJUSTABLE BETWEEN 610-1000 MM
38	956511	1	• Fork	
39	913158	1	• Clevis pin	
40	907856	1	• Split pin	
41	940154	4	• Hexagon nut	

AQ225D

REF	PART NO.	QTY	DESCRIPTION	NOTES
42		2	• Rod	
43		1	• Tube	
44	956511	1	• Fork	
45	907856	1	• Split pin	
46	913158	1	• Clevis pin	
47		1	• Ball joint	
48	950386	1	• • Lock nut	ONLY INCLUDED IN 850673.