

AQ225D

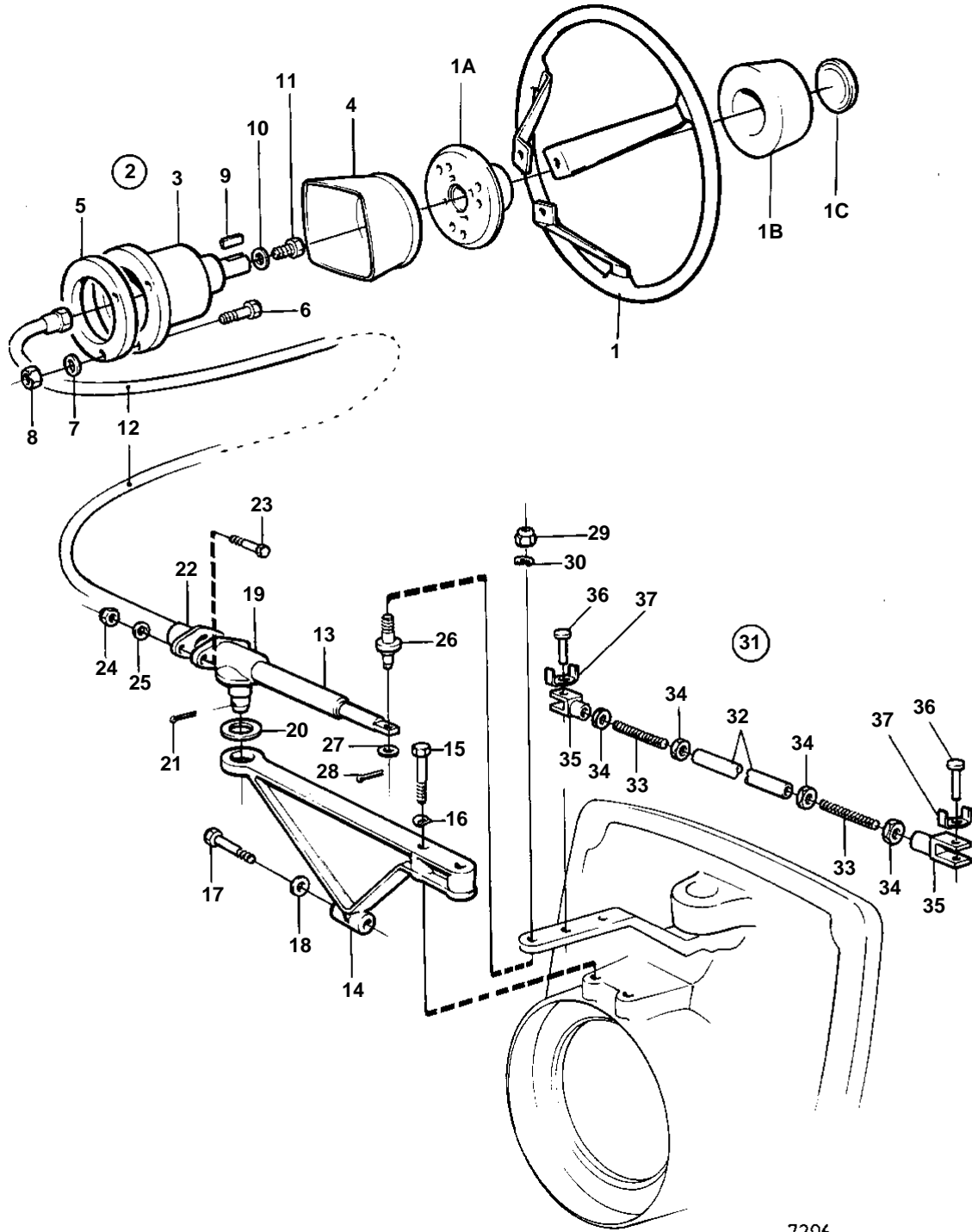

AQ225D

REF	PART NO.	QTY	DESCRIPTION	NOTES
1	850936	1	Steering wheel	
1A		1	• Steering wheel hub	
1B		1	• Steering wheel pad	
1C		1	• Emblem	
2		1	Steering gear	
3		1	• STEERING GEAR	
4		1	• Cover	
5		1	• Washer	
6	940101	3	• Hexagon screw	
7	941906	3	• Spring washer	
8	955781	3	• Hexagon nut	
9		1	• Key	
10		1	• Washer	
11	940148	1	• Hexagon screw	
12		X	Steering cable	L = 800 MM
		X	Steering cable	L = 2750mm
		X	Steering cable	L = 3000 MM
		X	Steering cable	L = 3250mm
		X	Steering cable	L = 3500mm
		X	Steering cable	L = 3750 MM
		X	Steering cable	L = 4000 MM
		X	Steering cable	L = 4250 MM
		X	Steering cable	L = 4500 MM
		X	Steering cable	L = 4750mm
		X	Steering cable	L = 5000 MM
		X	Steering cable	L = 5250mm
		X	Steering cable	L = 5500 MM
		X	Steering cable	L = 5750mm
		X	Steering cable	L = 6000 MM
		X	Steering cable	L = 6500mm
		X	Steering cable	L = 7000 MM
		X	Steering cable	L = 7500 MM
		X	Steering cable	L = 8000 MM
		X	Steering cable	L = 8500 MM
		X	Steering cable	L = 9000 MM
		X	Steering cable	L = 9500 MM
13		1	Steering cylinder	FOR STARBOARD MOUNTING.
		1	Steering cylinder	FOR PORT MOUNTING.
14		1	Guide bracket	
15	955324	2	Hexagon screw	
16	941908	2	Spring washer	
17	940142	1	Hexagon screw	
18	960141	1	Washer	
19		1	Anchorage	
20	955904	1	Washer	
21		1	Split pin	
22		1	Cardboard tube	
23	940101	2	Hexagon screw	
24	963105	2	Lock nut	
25	949607	2	Spring washer	
26	853077	1	Stud	
27	940097	1	Washer	
28	907844	1	Split pin	
29	963108	1	Lock nut	
30	949608	1	Spring washer	
31		1	Link stay	ONLY FOR TWIN INSTALLATION., ADJUSTABLE BETWEEN 610-970 MM.
32		1	• Tube	
33		2	• Rod	
34	940154	4	• Hexagon nut	
35	956511	2	• Fork	
36	913158	2	• Clevis pin	
37	853160	2	• Lock washer	