

AQ225F

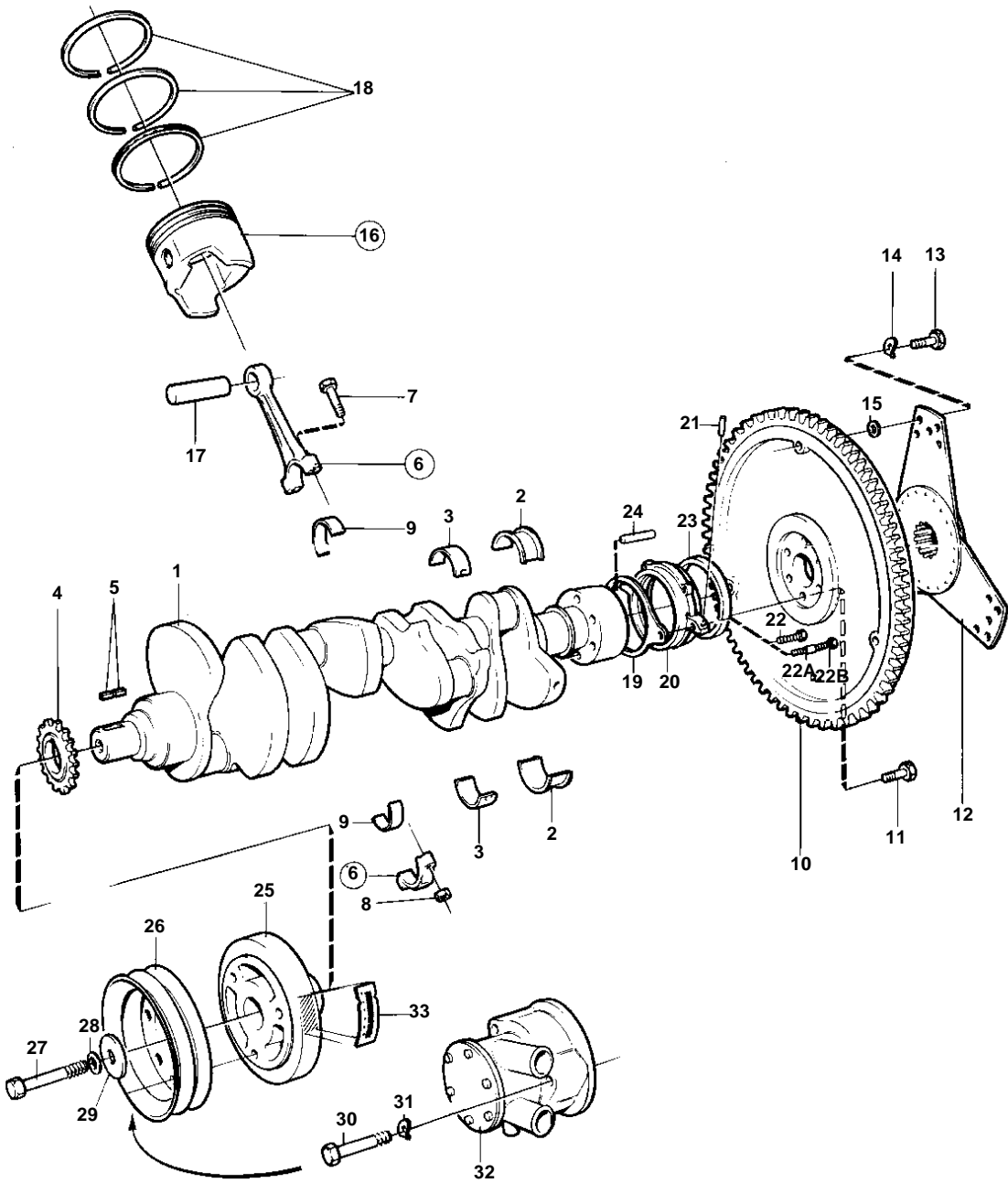

7956

**AQ225F**

REF	PART NO.	QTY	DESCRIPTION	SEE SEC.	NOTES
1		1	Crankshaft		
2	835052	1	Main bearing		INCL.IN CYLINDERBLOCK., STD
	835055	1	Main bearing		UNDER SIZE 0,010"
	835065	1	Thrust bearing		UNDER SIZE 0,020"
3	835051	3	Main bearing		INCL.IN CYLINDERBLOCK., STD
	835053	4	Main bearing		UNDER SIZE 0,010"
	835054	4	Main bearing		UNDER SIZE 0,020"
	841254	1	Main bearing, MAIN BEARING SHELL		INCL.IN CYLINDERBLOCK., FRONT MAIN BEARING., STD
					UPPER
	841255	1	Main bearing, MAIN BEARING SHELL		INCL.IN CYLINDERBLOCK., FRONT MAIN BEARING., STD
					LOWER
4		1	SPROCKET	17184	
5	835059	2	Key		
6	841867	8	Connecting rod		
7	835066	16	· Screw		
8	835473	16	· Nut		
9	835273	8	Bearing shell		STD
	835396	8	Bearing		UNDER SIZE 0,010"
	835070	8	Bearing		UNDER SIZE 0,020"
10	855814	1	Flywheel		
11	855815	6	Screw		
12	855694	1	Absorber		
13	835482	3	Screw		
14	942336	3	Spring washer		
15	940097	3	Washer		
16	826465	8	Piston		INCL.IN CYLINDERBLOCK., STD
	826466	8	Piston		OVER SIZE 0,030"
17		8	· GUDGEON PIN		
18	826469	8	Piston ring kit		INCL.IN CYLINDERBLOCK., STD
	826470	8	Piston ring kit		OVER SIZE 0,030"
19	855810	1	Gasket		
20	855907	1	Retainer		(855807)
21	855808	2	Stud		
22	855811	2	Screw		
	855812	1	Screw		
22A	855813	1	Stud		
22B		1	Flange nut		
23	855809	1	Crankshaft seal		
24	835057	1	Pin		
25	826477	1	Vibration damper		
26	835407	1	Pulley		
27	949518	1	Hexagon screw		
28		1	Lock washer		
29	835409	1	Washer		
30	948324	3	Hex. socket screw		
31	942336	3	Spring washer		
32		1	SEA WATER PUMP		SEE GROUP 2B
33	834842	1	Decal		