

AQ225D

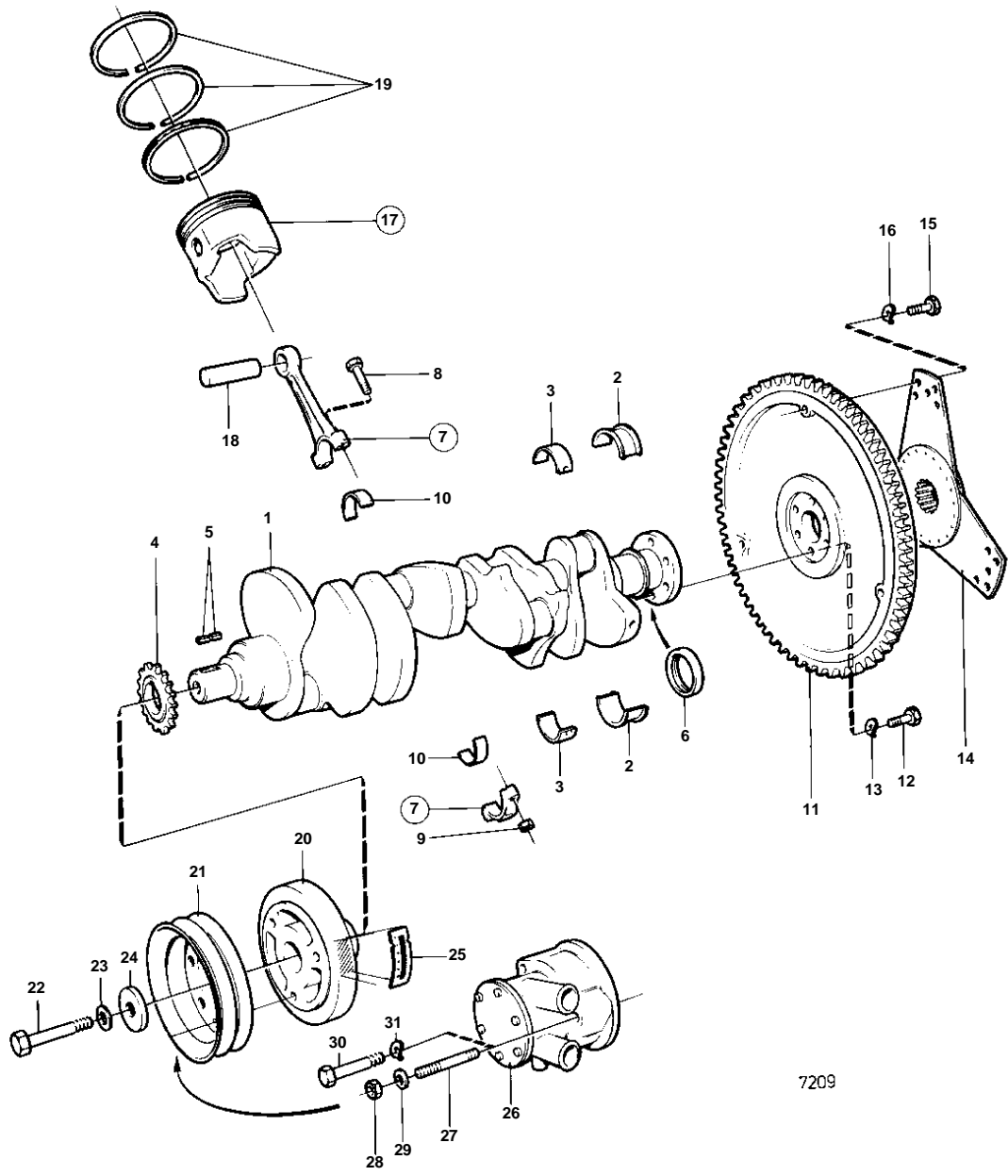

7209

AQ225D

REF	PART NO.	QTY	DESCRIPTION	SEE SEC.	NOTES
1		1	Crankshaft		
2	835052	1	Main bearing		INCL.IN CYLINDERBLOCK., STD
	835055	1	Main bearing		UNDER SIZE 0,010"
	835065	1	Thrust bearing		UNDER SIZE 0,020"
3	835051	3	Main bearing		INCL.IN CYLINDERBLOCK., STD
	835053	4	Main bearing		UNDER SIZE 0,010"
	835054	4	Main bearing		UNDER SIZE 0,020"
	841254	1	Main bearing, MAIN BEARING SHELL		INCL.IN CYLINDERBLOCK., FRONT MAIN BEARING., STD
	841255	1	Main bearing, MAIN BEARING		UPPER INCL.IN CYLINDERBLOCK., FRONT MAIN BEARING., STD
					LOWER
4		1	SPROCKET	17182	
5	835059	2	Key		
6	841240	1	Crankshaft seal		INCL.IN CYLINDERBLOCK.
		2	Sealing		FOR ENGINE WITH OPPOSITE ROTATION.
7	841867	8	Connecting rod		
8		16	· Hex. socket screw		
9	835473	16	· Nut		
10	835273	8	Bearing shell		STD
	835396	8	Bearing		UNDER SIZE 0,010"
	835070	8	Bearing		UNDER SIZE 0,020"
11	835432	1	Flywheel		
12	835439	6	Screw		
13	941909	6	Spring washer		
14	855694	1	Absorber		
15	835482	3	Screw		
16	942336	3	Spring washer		
17	826465	8	Piston		INCL.IN CYLINDERBLOCK., STD
	826466	8	Piston		OVER SIZE 0,030"
18		8	· GUDGEON PIN		
19	826469	8	Piston ring kit		INCL.IN CYLINDERBLOCK., STD
	826470	8	Piston ring kit		OVER SIZE 0,030"
20	826477	1	Vibration damper		
21	835407	1	Pulley		
22	949518	1	Hexagon screw		
23		1	Lock washer		
24	835409	1	Washer		
25	834842	1	Decal		
26		1	SEA WATER PUMP		SEE GROUP 2B
27	826500	3	Stud		EARLY TYPE
28		3	Lock nut		EARLY TYPE
29	941907	3	Spring washer		EARLY TYPE
30	948324	3	Hex. socket screw		LATE TYPE
31	942336	3	Spring washer		LATE TYPE