

AQ211A

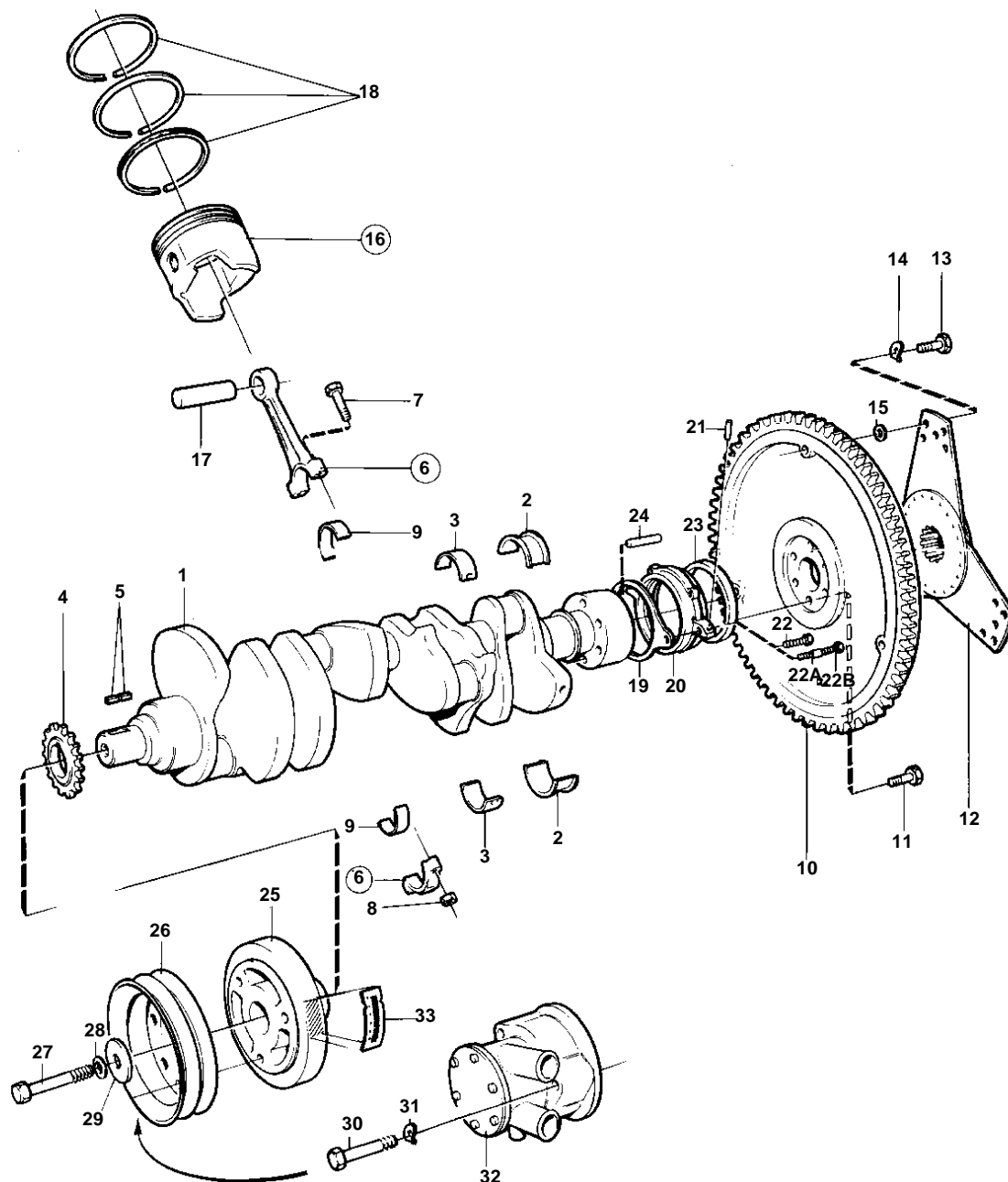

7956

AQ211A

REF	PART NO.	QTY	DESCRIPTION	SEE SEC.	NOTES
1		1	Crankshaft		
2	856439	1	Thrust bearing		STD (835052)
	856666	1	Thrust bearing		UNDER SIZE 0,010" (83505)
	856765	1	Main bearing		UNDER SIZE 0,020" (83506)
3	856739	6	Main bearing		STD (835051)
	841254		· Main bearing, MAIN BEARING SHELL		STD, REPL BY 856739
					UPPER
	841255		· Main bearing, MAIN BEARING SHELL		STD, REPL BY 856739
					LOWER
	856342	6	Main bearing		UNDER SIZE 0,010" (83505)
	856764	6	Main bearing		UNDER SIZE 0,020" (83505)
4		1	SPROCKET	17356	
5	835059	2	Key		
6	841867	8	Connecting rod		
7	835066	16	· Screw		
8	835473	16	· Nut		
9	856669	8	Rod bearing		STD (835273)
	856740	8	Main bearing		UNDER SIZE 0,010" (83539)
	856738	8	Rod bearing		UNDER SIZE 0,020" (83507)
10	855814	1	Flywheel		
11	835439	6	Screw		(855815)
12	855694	1	Absorber		(855648)
13	835482	3	Screw		
14	942336	3	Spring washer		
15	940097	3	Washer		
16	856061	8	Piston		WHEN ORDERING SEPARATE PISTONS, NOTE THE MARKING ON THE UNDERSIDE OF THE CYLINDER BLOCK., ALT, FGH 305-87 S4
	856062	8	Piston		WHEN ORDERING SEPARATE PISTONS, NOTE THE MARKING ON THE UNDERSIDE OF THE CYLINDER BLOCK., ALT, JKL 305-87 S5
					REPL BY 856061
	856063	8	Piston		OVER SIZE 0,030"
17		8	· GUDGEON PIN		
18	826469	8	Piston ring kit		INCL.IN CYLINDERBLOCK., STD
	826470	8	Piston ring kit		OVER SIZE 0,030"
19	855810	1	Gasket		
20	855907	1	Retainer		(855807)
21	855808	2	Stud		
22	855811	2	Screw		
	855812	1	Screw		
22A	855813	1	Stud		
22B		1	Flange nut		
23	855809	1	Crankshaft seal		
24	835057	1	Pin		
25	856420	1	Vibration damper		(826477)
26	835407	1	Pulley		
27	949518	1	Hexagon screw		
28		1	Lock washer		
29	835409	1	Washer		
30	948324	3	Hex. socket screw		
31	942336	3	Spring washer		
32		1	SEA WATER PUMP		SEE GROUP 2B
33		1	Decal		