

COMMON

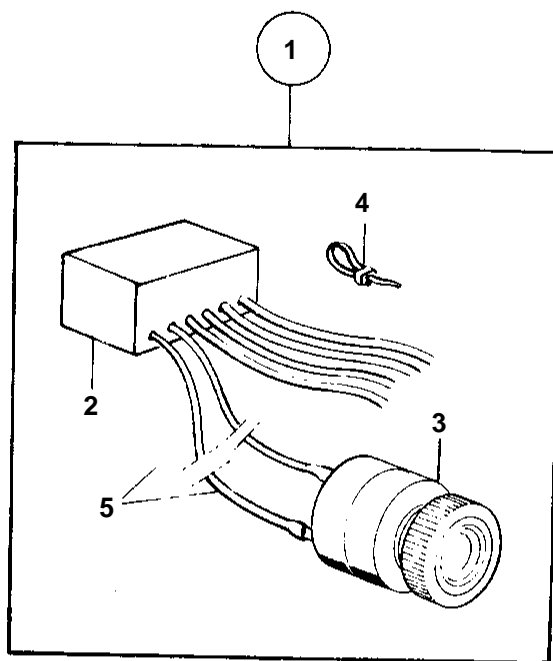

30 24

COMMON

REF	PART NO.	QTY	DESCRIPTION	NOTES
1	827941	1	Alarm kit	24V
2	831627	1	• Thermo monitor	24V
3	827597	1	• Horn unit	
4	948210	2	• Strip clamp	(827353)
5		X	• CABLES AND CABLE • TERMINALS	SEE GROUP 3