

COMMON

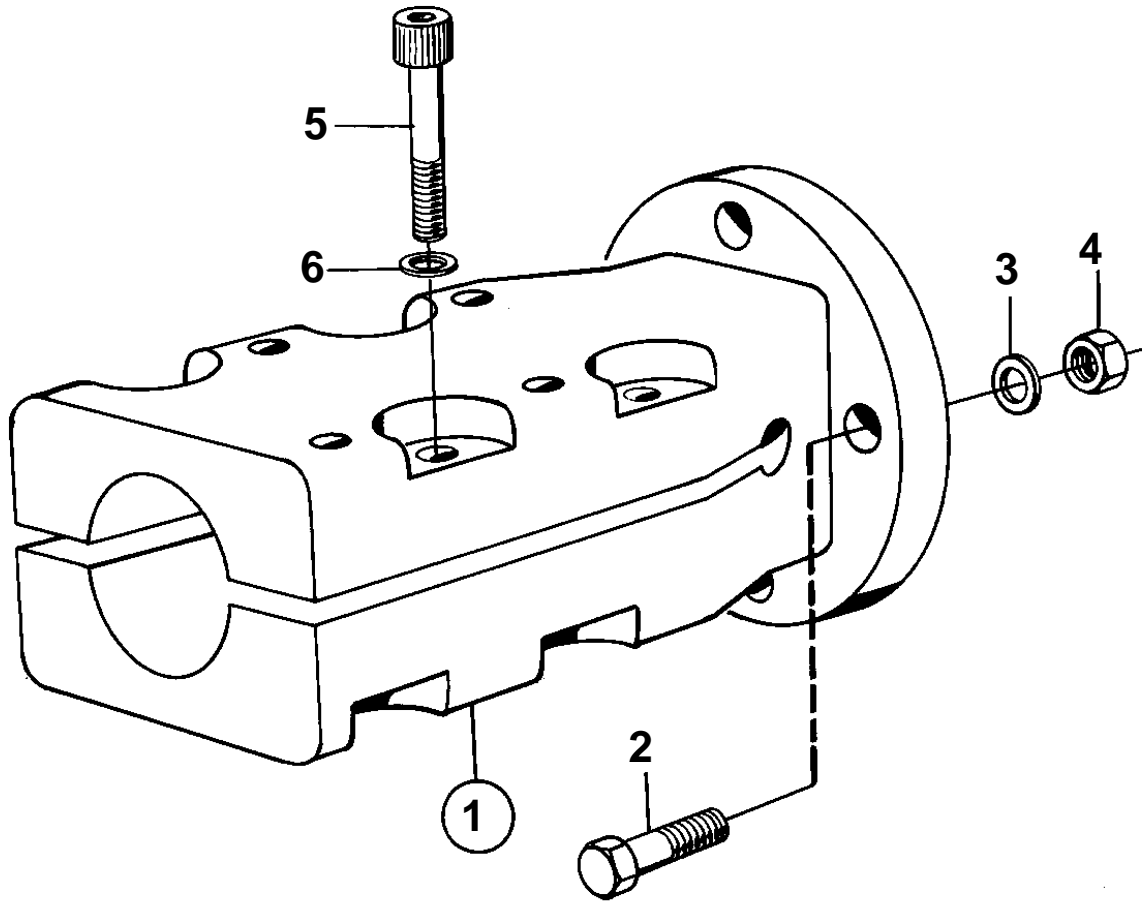

4623

COMMON

REF	PART NO.	QTY	DESCRIPTION	NOTES
1	828390	1	Clamp coupling	30MM HOLE FOR PROPELLER SHAFT.
2	955693	4	· Screw	L = 38 MM
	955691	4	· Screw	L = 25 MM
3	941909	4	· Spring washer	
4	950375	4	· Nut	
5	948670	8	· Screw	
6	947345	8	· Washer	