

8.1GiI-E, 8.1GXil-D

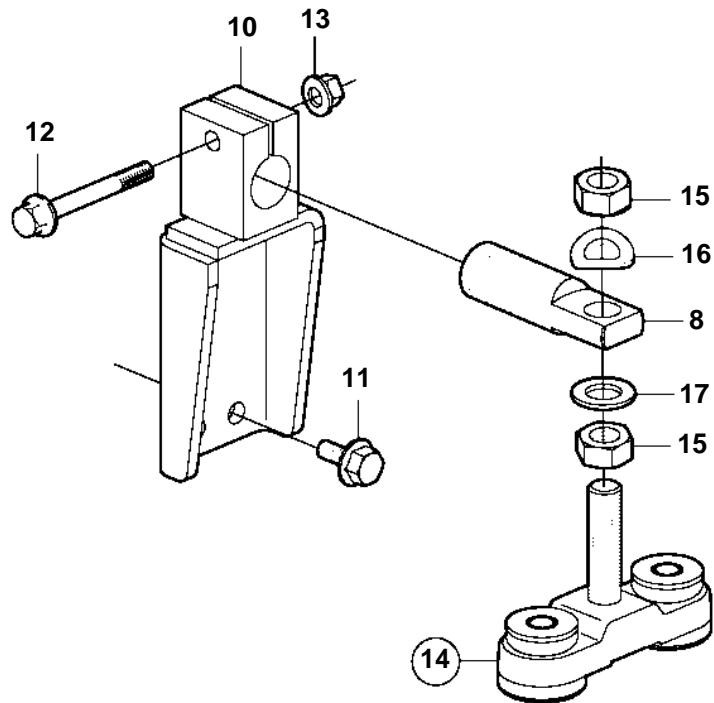
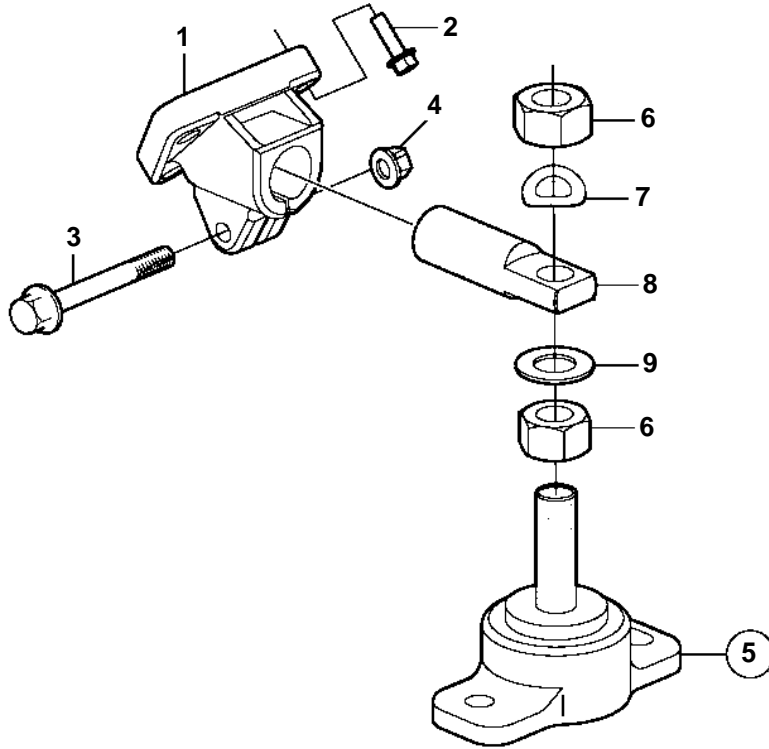

8.1GiI-E, 8.1GXii-D

REF	PART NO.	QTY	DESCRIPTION
1	3863314	2	Bracket
2	946472	6	Screw
3	3860499	2	Screw
4	3857181	2	Flange lock nut
5	857251	2	Rubber cushion
6	955860	4	· Nut
7	941914	2	Spring washer
8	3863365	4	Pin
9	3857588	2	Washer
10	3858473	2	Bracket
11	965191	8	Screw
12	3855595	2	Screw
13	946175	2	Nut
14	3858470	2	Rubber cushion
15	955860	4	· Nut
16	941914	2	· Spring washer
17	955902	2	· Washer