

8.1GiI-A, 8.1GiI-B, 8.1GiI-C, 8.1GiI-D, 8.1GSiI-A, 8.1GXii-A, 8.1GXii-B, 8.1GXii-C

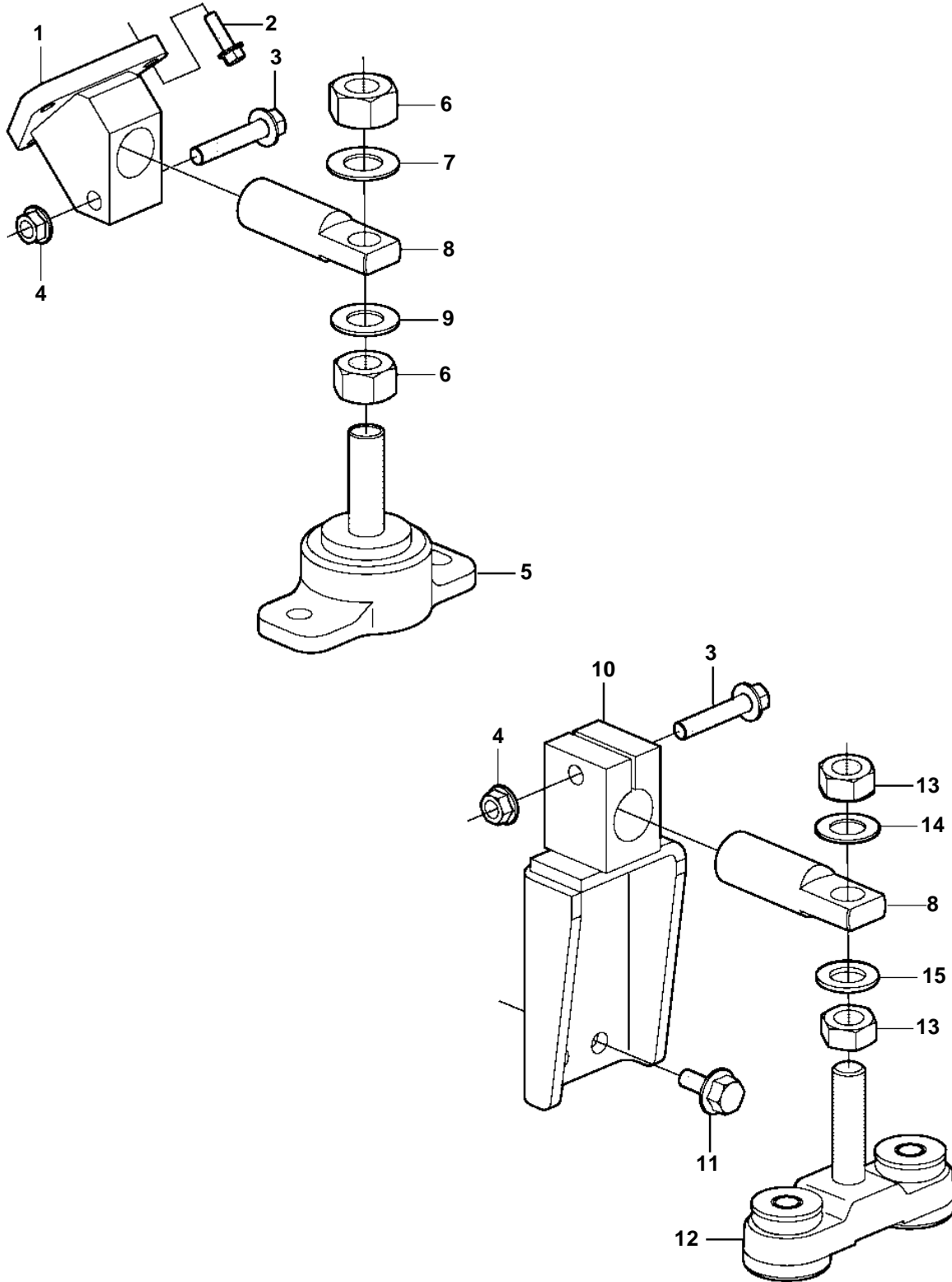

8.1GiI-A, 8.1GiI-B, 8.1GiI-C, 8.1GiI-D, 8.1GSiI-A, 8.1GXiI-A, 8.1GXiI-B, 8.1GXiI-C

REF	PART NO.	QTY	DESCRIPTION
1	3858471	2	Bracket
2	946472	6	Screw
3	3855595	4	Screw
4	946175	4	Nut
5	857251	2	Rubber cushion
6	955860	4	· Nut
7	941914	2	Spring washer
8	841247	2	Pin
9	955902	2	Washer
10	3860770	2	Bracket
11	965191	8	Screw
12	3858470	2	Rubber cushion
13	955860	4	· Nut
14	941914	2	· Spring washer
15	955902	2	· Washer