

500A, 501A

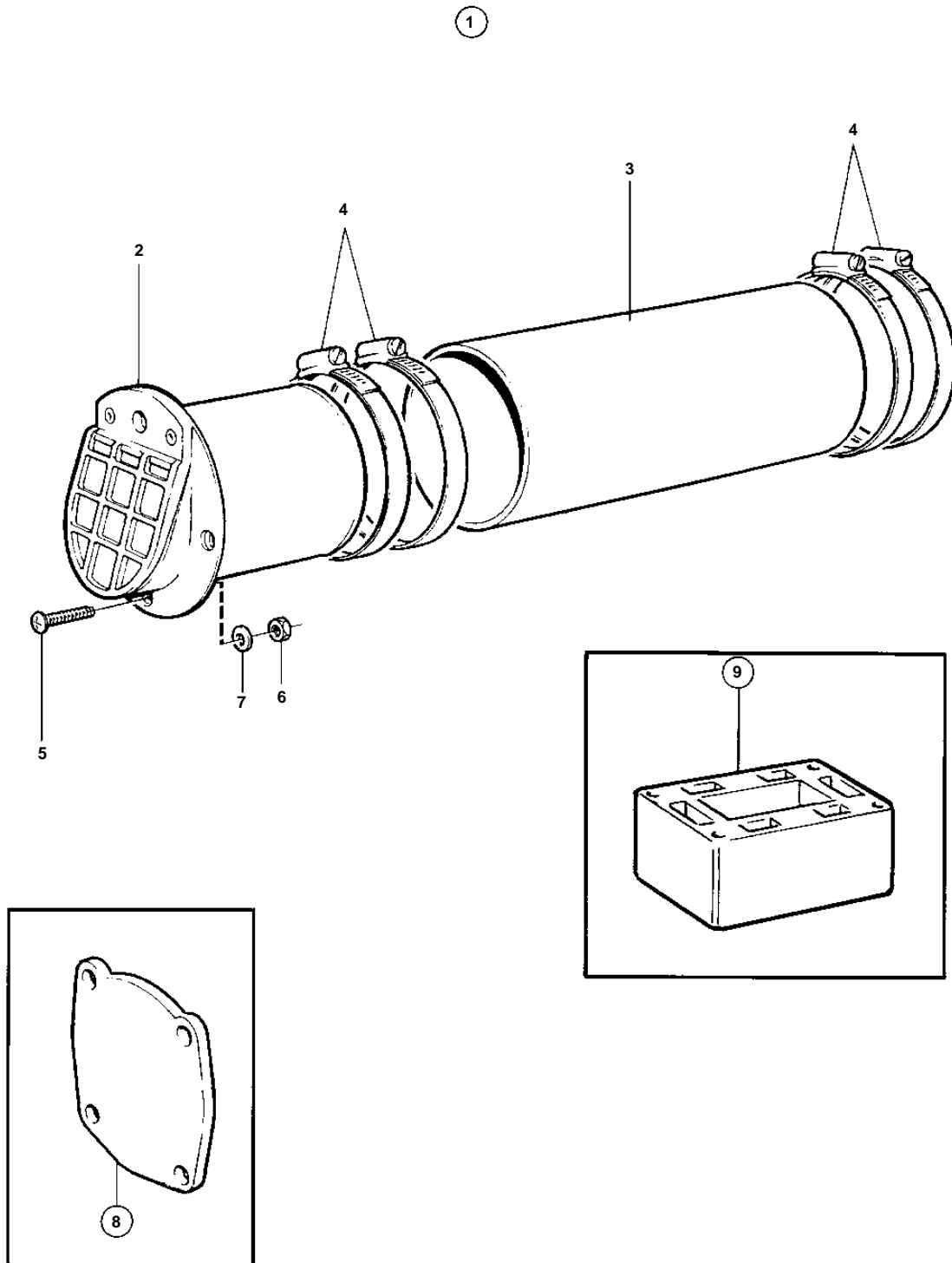

10014

