

TAMD74A-A, TAMD74A-B, TAMD74C-A, TAMD74L-A, TAMD74P-A, TAMD74C-B, TAMD74L-B, TAMD74P-B, TAMD75P-A

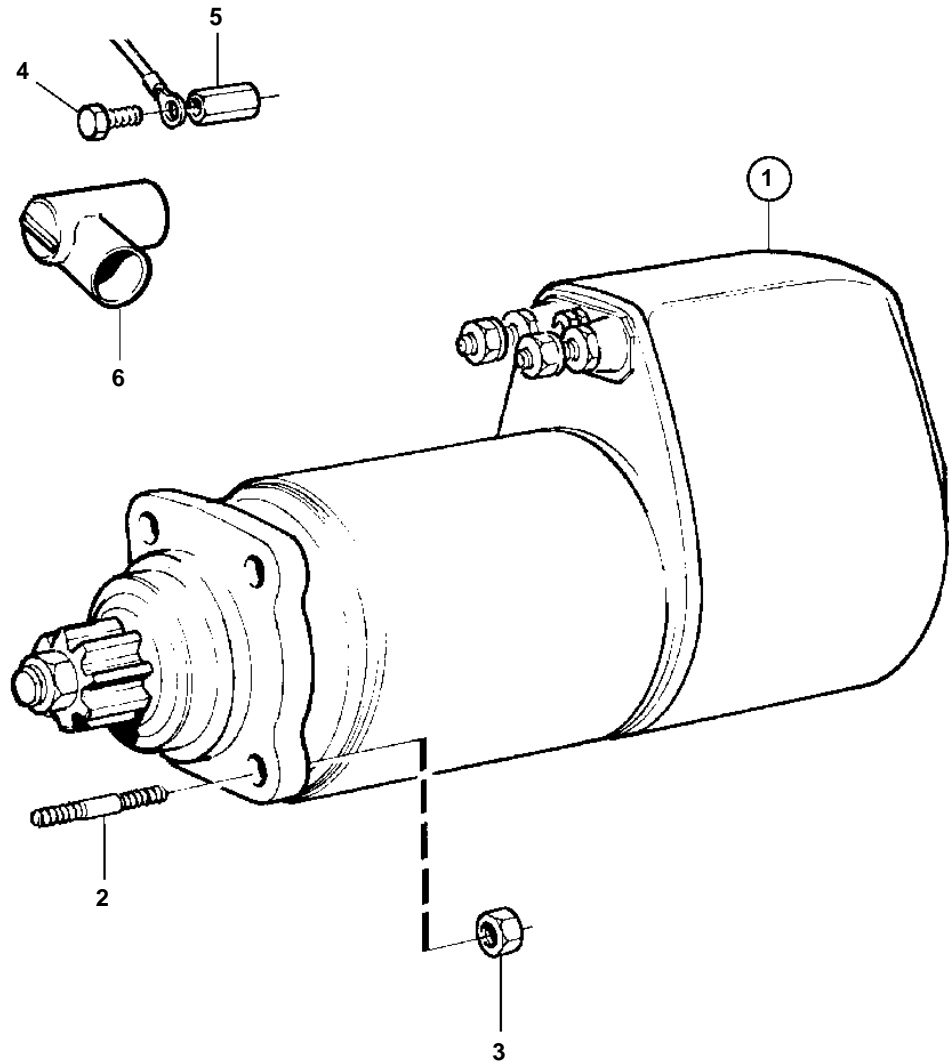

18235

TAMD74A-A, TAMD74A-B, TAMD74C-A, TAMD74L-A, TAMD74P-A, TAMD74C-B, TAMD74L-B, TAMD74P-B, TAMD75P-A

REF	PART NO.	QTY	DESCRIPTION	NOTES
1	881683	1	Starter motor	E.U=3803600
	3803600	1	Starter motor, exch	Exchange unit
			Comps. not spec.	
2	953069	3	Stud	
3	971095	3	Nut	
4	946670	2	Flange screw	
5	857180	2	Nut	
6	855798	2	Protecting sleeve	