

TAMD73P-A, TAMD74C-A, TAMD74L-A, TAMD74P-A, TAMD74C-B, TAMD74L-B, TAMD74P-B, TAMD75P-A

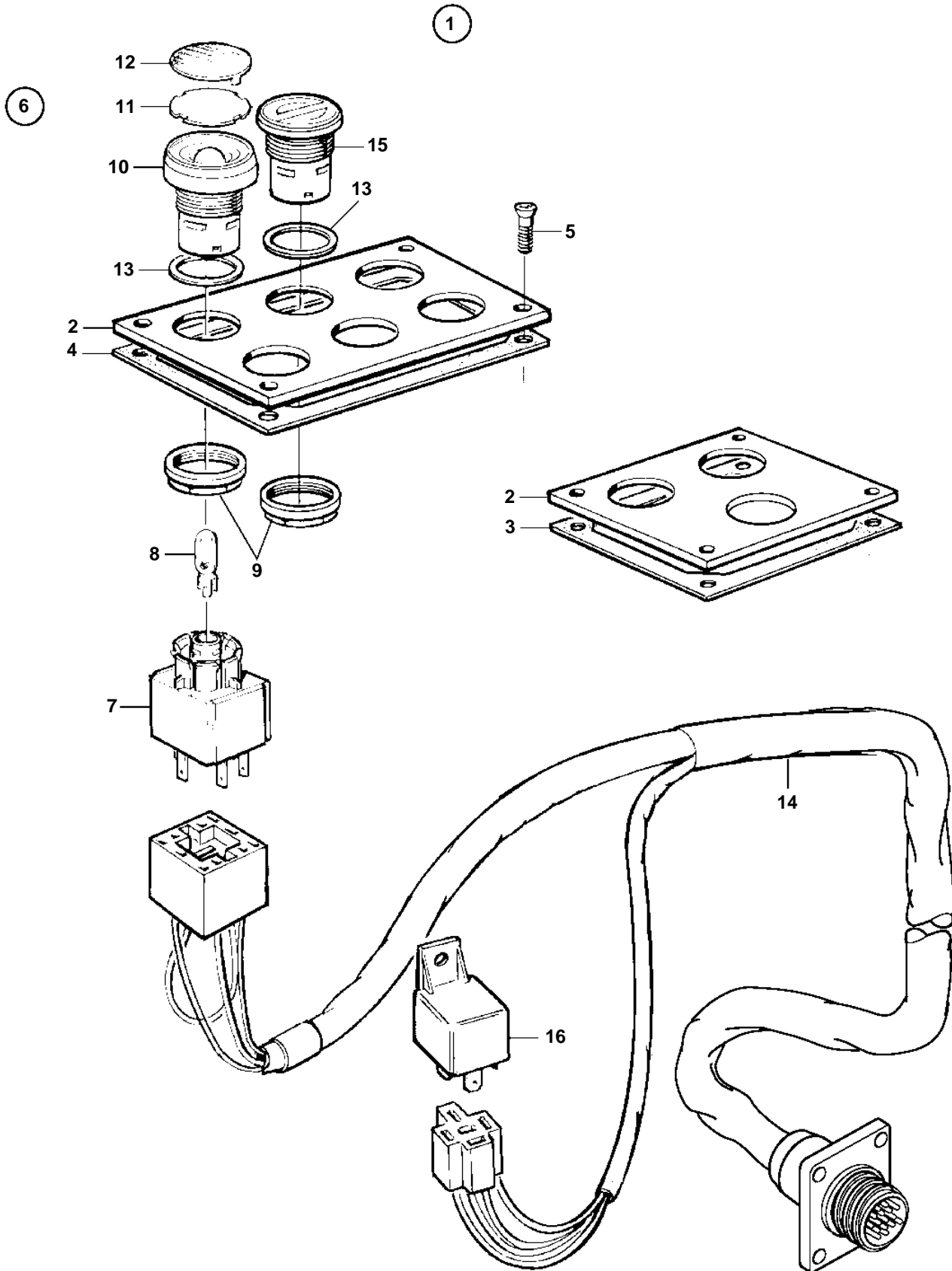

TAMD73P-A, TAMD74C-A, TAMD74L-A, TAMD74P-A, TAMD74C-B, TAMD74L-B, TAMD74P-B, TAMD75P-A

REF	PART NO.	QTY	DESCRIPTION	NOTES
1	873892	1	Control panel	6 HOLE, 12V. Twin engine installation. For single or multi stations.
2	873733	1	• Plate	6 HOLE. Twin engine installation. For single or multi stations.
3	828647	4	• Screw	
4	876950	6	• Push button	
5		6	• • Connector unit	
6	942327	6	• • Bulb	12V, 1,2W
	943638	6	• • Bulb	24V, 1,2W
7		6	• • Attaching ring	
8		6	• • Button	
9		36	• • Symbol strip	
10		6	• • Cover plate	GREEN
		6	• • Cover plate	YELLOW
		6	• • Cover plate	RED
		6	• • Cover plate	BLUE
11		6	• • Gasket	
12	873871	1	• Cable kit	
13	873750	X	• Plastic plug	
14	873765	1	• Relay	