

TAMD74A-A, TAMD74A-B, TAMD74C-A, TAMD74L-A, TAMD74P-A, TAMD74C-B, TAMD74L-B, TAMD74P-B, TAMD75P-A

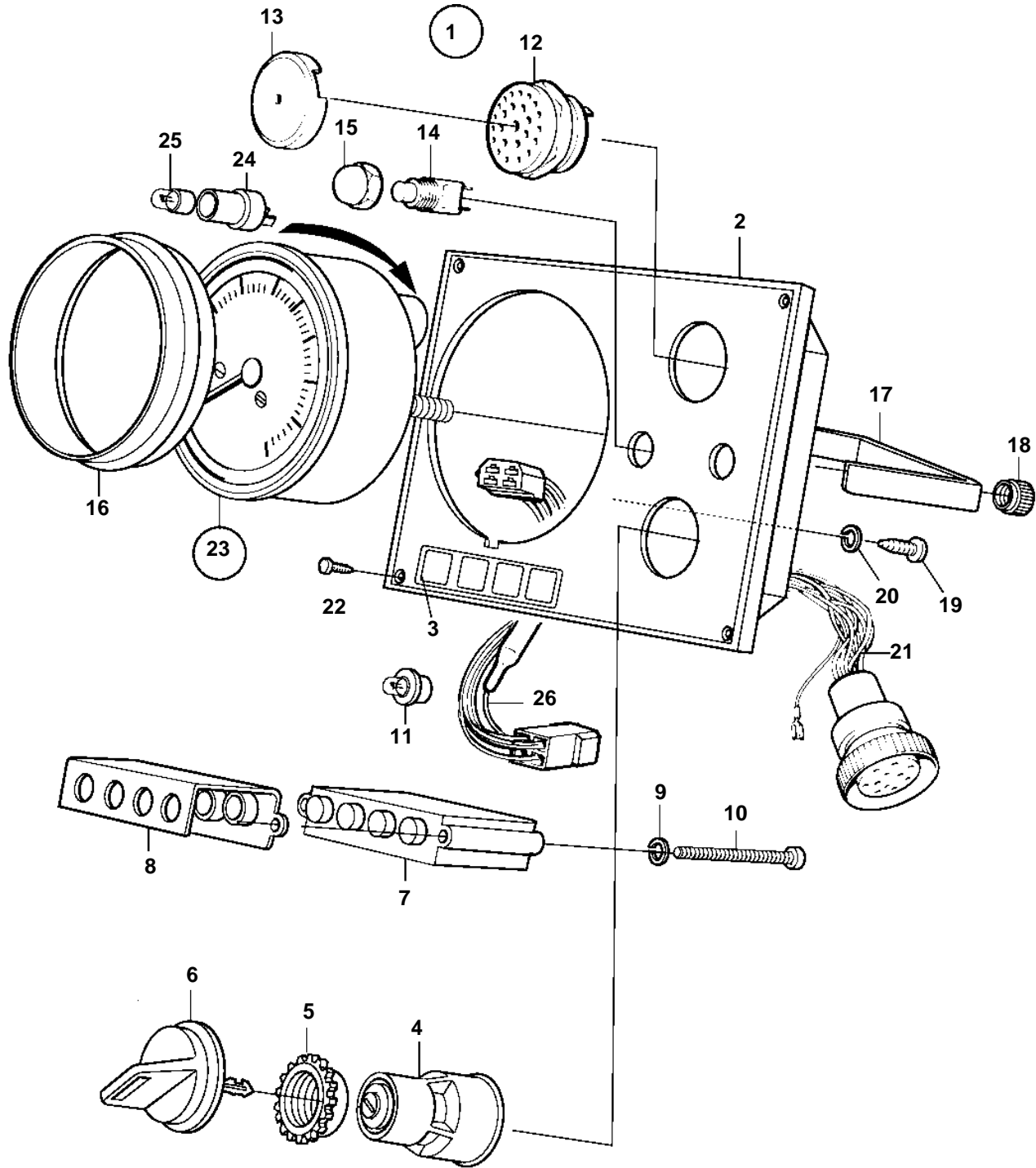

TAMD74A-A, TAMD74A-B, TAMD74C-A, TAMD74L-A, TAMD74P-A, TAMD74C-B, TAMD74L-B, TAMD74P-B, TAMD75P-A

REF	PART NO.	QTY	DESCRIPTION	SEE SEC.	NOTES
1	873592	1	Instrument panel		
2	860183	1	• Instrument panel		
3	858645	1	• Symbol strip		
4	864277	1	• Starter switch		
5	859955	1	• • Plastic nut		
6	859953	2	• • Key		State key code when ordering.
			• • Bulletin 49-30	49-30-EN	Key P/N 859953 (873209)
7	873737	1	• Electronic unit		
8	828784	1	• Reflector		
9	941904	2	• Spring washer		
10	941615	2	• Screw		
11	828818	4	• Bulb		24V
12	828587	1	• Buzzer		
13	858795	1	• Protecting casing		
14	828584	1	• Switch		ALARM TEST
	828585	1	• Switch		INSTR. LIGHT
15	828586	2	• Nut		
16	873517	1	• Front ring		
17	873208	1	• Retainer		
18		2	• • Nut		
19	949947	1	• Screw		
20	941904	1	• Spring washer		
21	828648	1	• Cable kit		
22	828647	4	• Screw		
23	873998	1	Rev counter kit		3400 RPM,12/24V (873586) (876750)
24	863945	1	• Bulb socket		
25	863946	1	• Bulb		12V, 1,2W
	863947	1	• Bulb		24V, 1,2W
26	873695	1	• Diode cable		