

TAMD72P-A

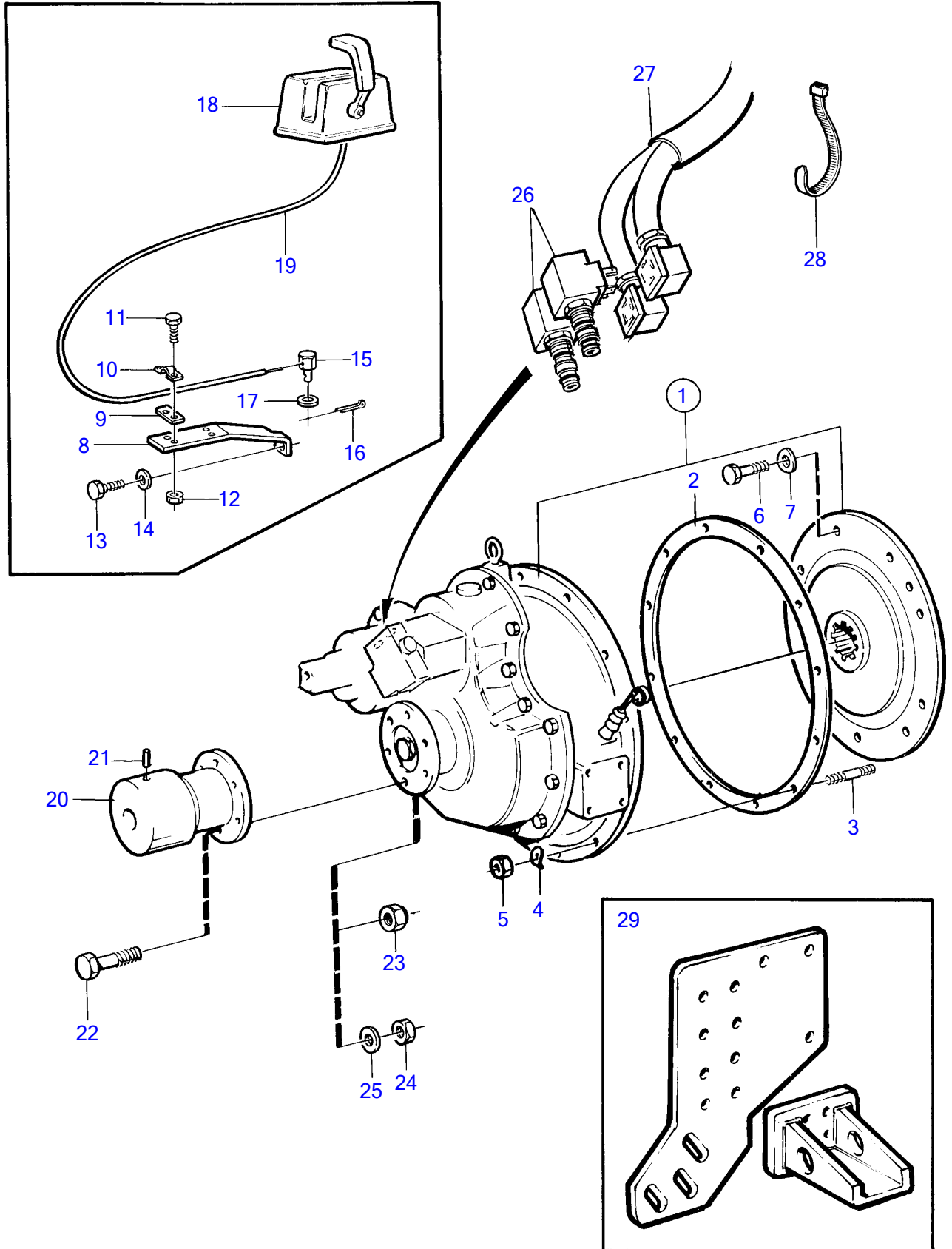

TAMD72P-A

REF	PART NO.	QTY	DESCRIPTION	NOTES
1		1	Reversing gear • parts not sold separately	Ratio -2.99:1
2	862623	1	Gasket	
3	953486	11	Stud	
4	942336	11	Spring washer	
5	955827	11	Hexagon nut	
6	956582	8	Hex. socket screw	
7	942336	8	Spring washer	
8	863483	1	Bracket	
9	819068	1	Washer	
10	21471054	1	Bracket	For control cable 333, 33C.
	6853782	1	Cable clamp	For control cable 443, 43C.
11	956079	2	Cross recessed screw	
12	963104	2	Lock nut	
13	970948	1	Hexagon screw	
14	941908	1	Spring washer	
15	853217	1	Cube	
16	17253	1	Split pin	
17	940191	1	Washer	
18		X	Control	See group 27
19		X	Control cable	See group 27
20	842106	1	Companion flange	For reverse gear ratio -1.98:1.
	(865434)	1	Clutch flange	For reverse gear ratio 2.98:1-., Obsolete part
21	(965011)	2	Pin	For reverse gear ratio 2.98:1-., Obsolete part
22	955739	6	Hexagon screw	For reverse gear ratio -1.98:1., L=64mm
	955751	6	Hexagon screw	For reverse gear ratio 2.98:1-., L=64mm
23	950379	6	Lock nut	For reverse gear ratio 2.98:1-.
24	950378	6	Lock nut	For reverse gear ratio -1.98:1.
25	941912	6	Spring washer	For reverse gear ratio -1.98:1.
	941914	6	Spring washer	For reverse gear ratio 2.98:1-., Obsolete part
26	3825653	1	Actuator solenoid	12V
	3825654	1	Control magnet kit	24V
27	873827	1	Cable kit	(873659)
28	948211	2	Cable tie	
29		2	Engine suspension	See group 21