

TAMD72P-A

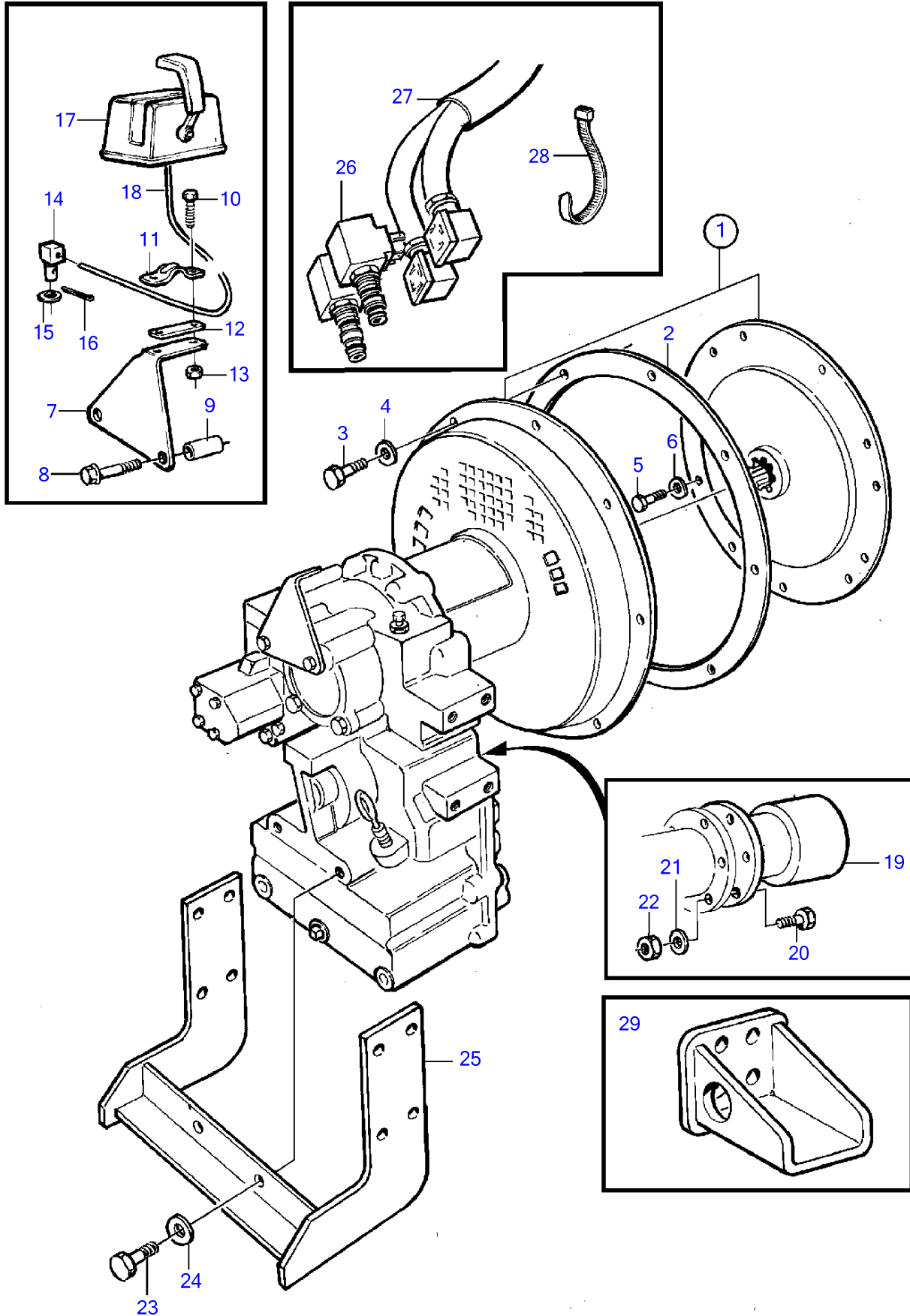

TAMD72P-A

REF	PART NO.	QTY	DESCRIPTION	NOTES
1		1	Reversing gear • parts not sold separately	Ratio 2.07:1, Ratio 1.83:1
2	862623	1	Gasket	
3	955535	12	Hexagon screw	L=32mm
	956582	12	Hex. socket screw	L=19mm, alt
4	942336	12	Spring washer	
5	956582	8	Hex. socket screw	
6	942336	8	Spring washer	
7	864242	1	Bracket	
8	955570	2	Hexagon screw	
9	830672	2	Spacer sleeve	
10	956079	2	Cross recessed screw	
11	21471054	1	Bracket	For control cable 333, 33C.
	6853782	1	Cable clamp	For control cable 443, 43C.
12	819068	1	Washer	
13	963104	2	Lock nut	
14	853217	1	Cube	
15	940191	1	Washer	
16	17253	1	Split pin	
17		X	Control	See group 27
18		X	Control cable	See group 27
19	842106	1	Companion flange	
20	955739	6	Hexagon screw	
21	941912	6	Spring washer	
22	950378	6	Lock nut	
23	955589	2	Hexagon screw	
24	941912	2	Spring washer	
25		1	Bracket	See group 21
26	3825653	1	Actuator solenoid	12V
	3825654	1	Control magnet kit	24V
27	873827	1	Cable kit	
28	948211	2	Cable tie	
29		2	Engine suspension	See group 21