

TAMD73P-A

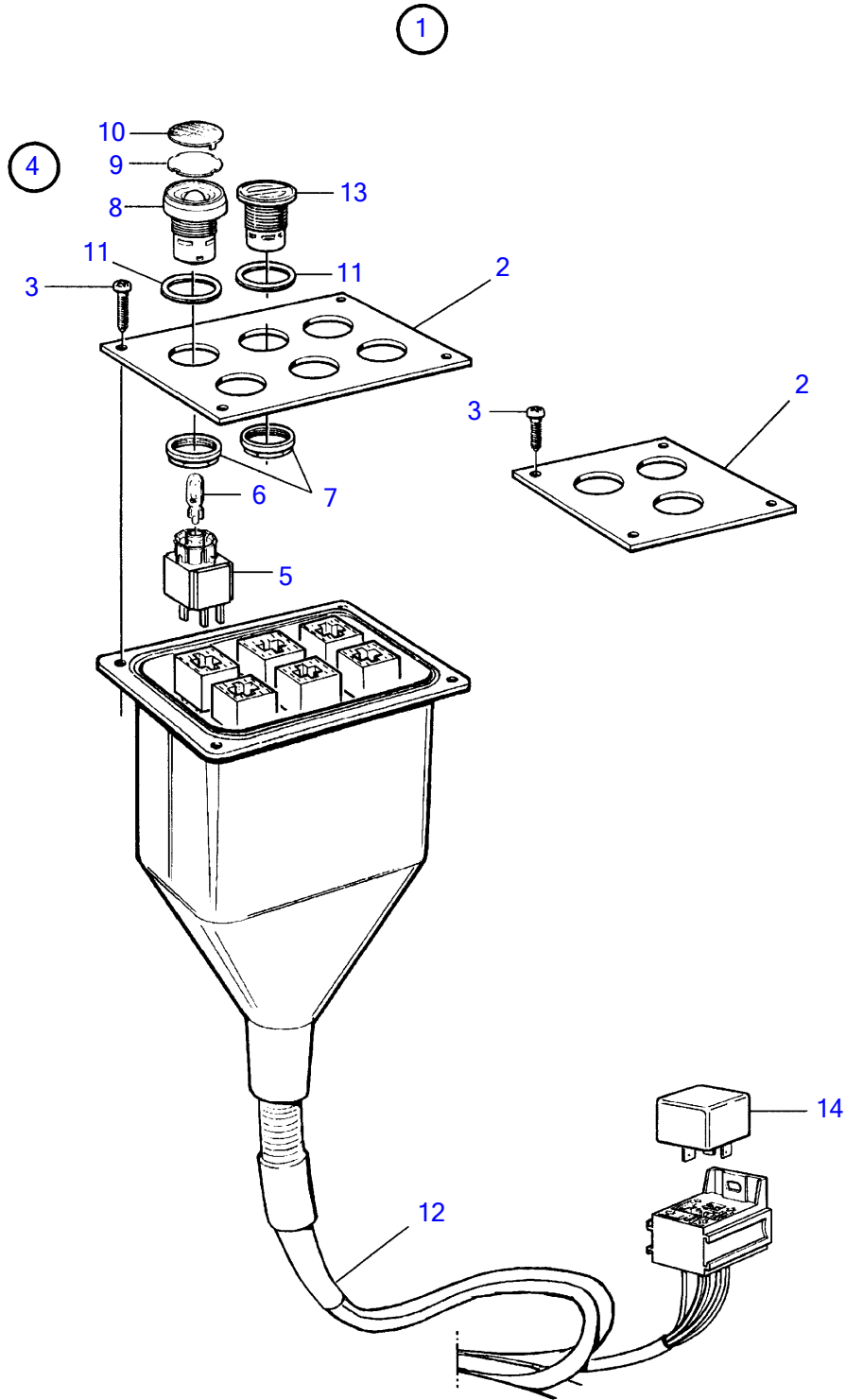

17080

TAMD73P-A

REF	PART NO.	QTY	DESCRIPTION	NOTES
1	873892	1	Control panel	Twin engine installation. For single or multi stations., 6 hole, 12V
2	873733	1	• Plate	Twin engine installation. For single or multi stations., 6 hole
3	828647	4	• Screw	
4	876950	6	• Push button kit	
5		6	• • Connector unit	
6	942327	6	• • Bulb	12V, 1,2W
	943638	6	• • Bulb	24V, 1,2W
7		6	• • Attaching ring	
8		6	• • Button	
9		36	• • Symbol strip	
10		6	• • Cover plate	Green
		6	• • Cover plate	Yellow
		6	• • Cover plate	Red
		6	• • Cover plate	Blue
11		6	• • Gasket	
12	873871	1	• Cable kit	
13	873750	X	• Plastic plug	
14	873765	1	• Relay	