

TAMD63P-A

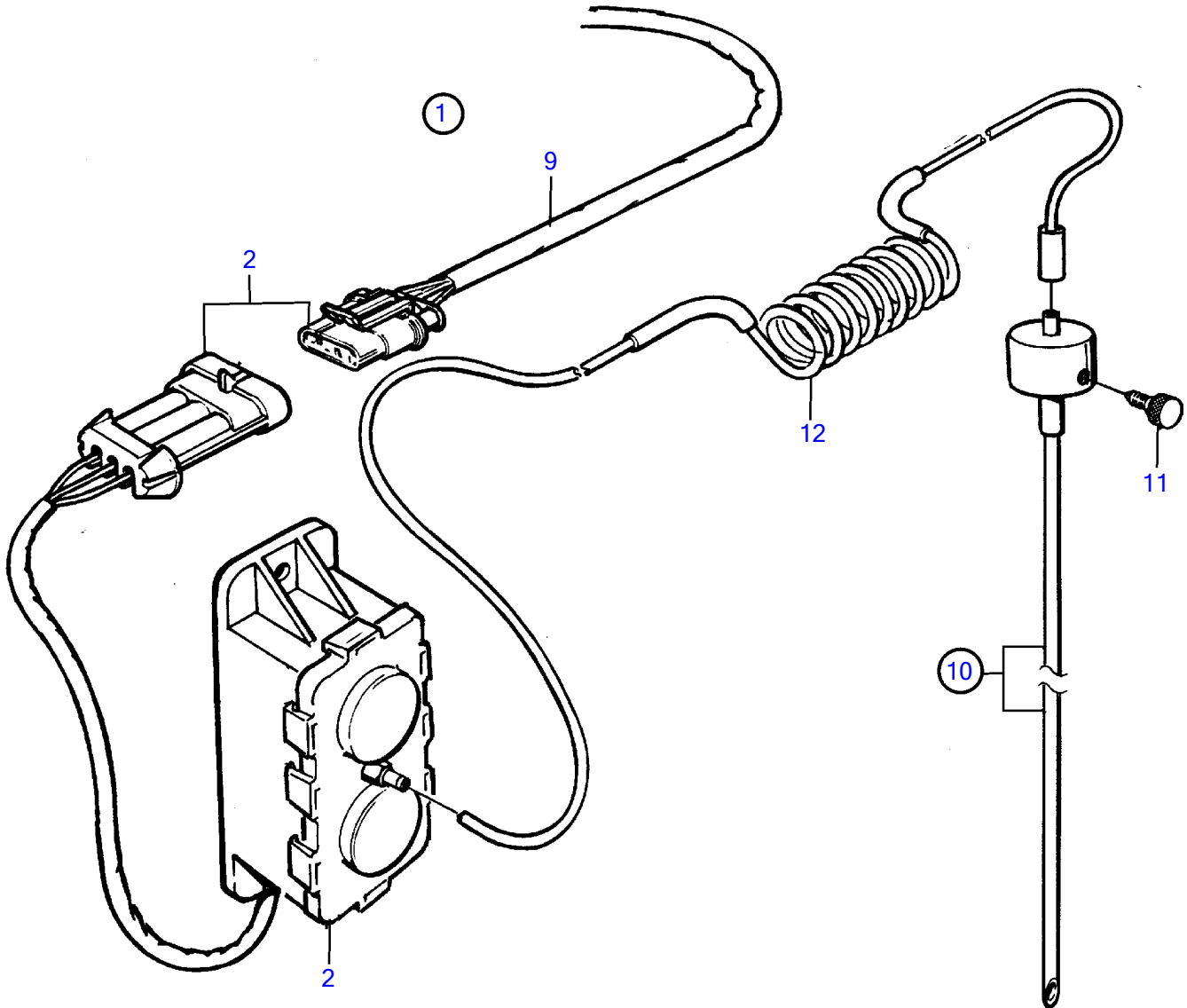
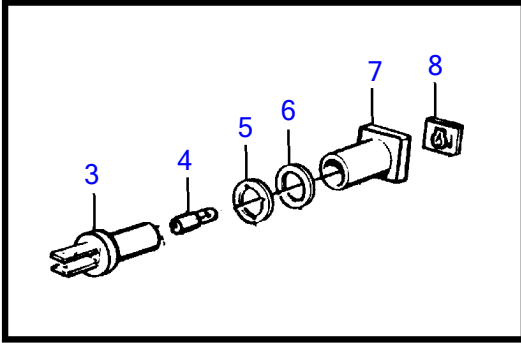

TAMD63P-A

REF	PART NO.	QTY	DESCRIPTION	NOTES
1	(866854)	1	Oil level sensor	12V, Obsolete part
2	(866831)	1	• Electronic unit	Obsolete part
3	808175	1	• Lamp socket	
4	19923	1	• Bulb	12V
5	967583	1	• Retainer	
6	829714	1	• Sealing ring	
7	838455	1	• Retainer	
8	866853	1	• Symbol strip	
9		X	electrical materials	See group 30
		X	cables and terminals	See group 30
10	(3825085)	1	Oil dipstick	Obsolete part
11		1	• Screw	
12		1	• Hose	