

DPX

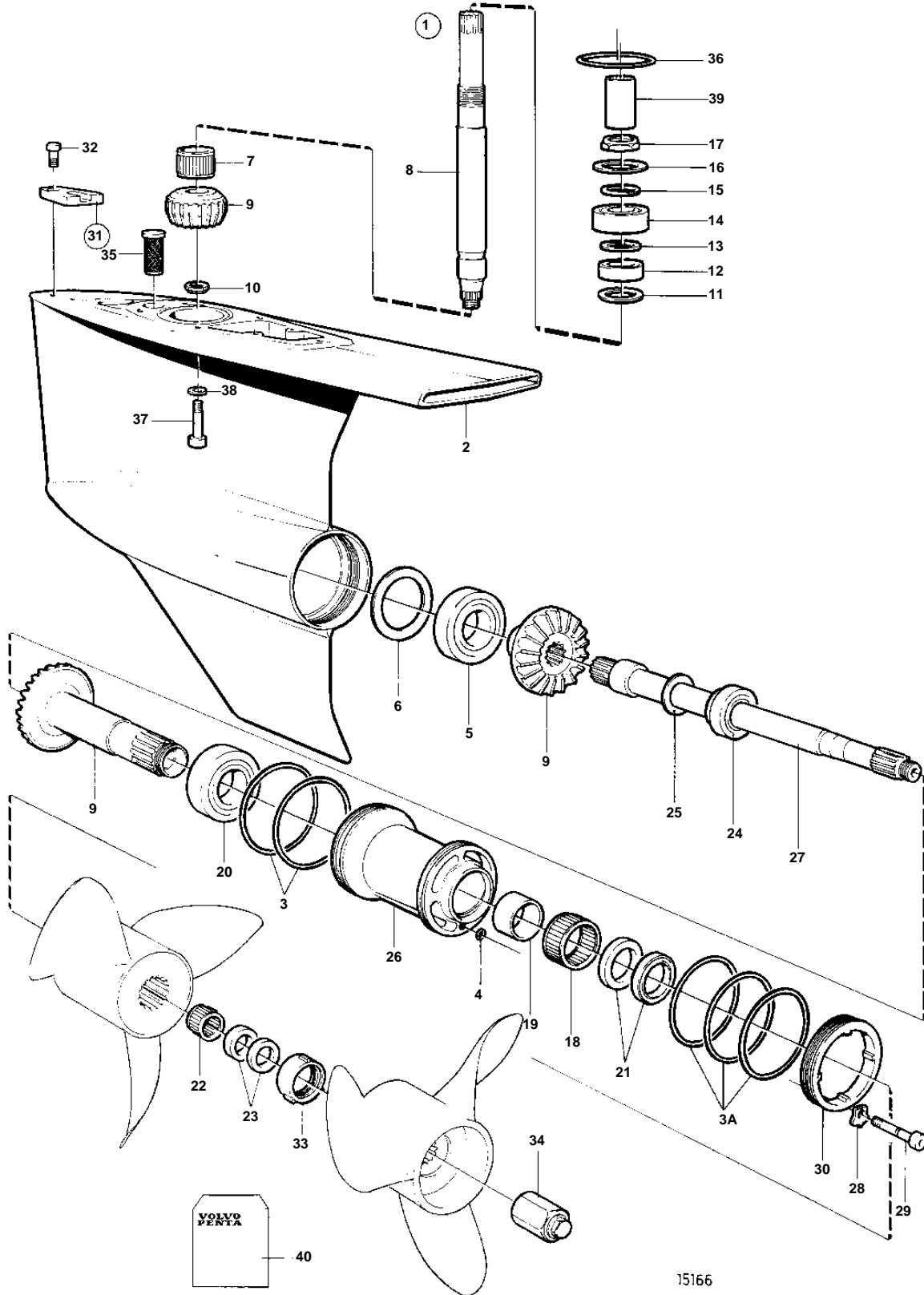

DPX

REF	PART NO.	QTY	DESCRIPTION	SEE SEC.	NOTES
1	872297	1	Gear under		RATIO 1.78:1
2	872134	1	• Gear housing		
3	873232	2	• O-ring		Included in gasket kit.
3A	946438	3	• O-ring		Included in gasket kit.
4	955981	1	• O-ring		Included in gasket kit.
5	11044	1	• Bearing		
6	967352	X	• Shim		TH=0,05mm
	941823	X	• Shim		TH = 0,10mm
	967351	X	• Shim		TH = 0.15mm
	941824	X	• Shim		TH=0,20mm
	941825	X	• Shim		TH=0,40mm
7	184654	1	• Needle bearing		
8	872293	1	• Countershaft		
9	872404	1	• Gear set		RATIO 1.78:1
10	852212	1	• Nut		Included in gasket kit.
11	941832	X	• Shim		TH=0,05mm
	941833	X	• Shim		TH=0,20mm
12	183374	1	• Ball bearing		
13	944970	1	• Shim		TH = 1,6mm
14	11072	1	• Roller bearing		
15	897387	1	• Spacer ring		
16	944522	X	• Shim		TH=0,05mm
	42981	X	• Shim		TH = 0,10mm
	968057	X	• Shim		TH=0,20mm
	42980	X	• Shim		TH=0.35mm
17	969071	1	• Round nut		Included in gasket kit.
18	183859	1	• Needle bearing		
19	184683	1	• Inner ring		
20	184765	1	• Roller bearing		
21	851407	2	• Sealing ring		Included in gasket kit.
22	183272	1	• Needle bearing		
23	853871	1	• Sealing ring kit		Included in gasket kit.
24	184691	1	• Bearing		
25	191834	X	• Shim		TH = 0,10mm
	191835	X	• Shim		TH = 0.15mm
	191837	X	• Shim		TH = 0,25mm
26	872136	1	• Bearing housing		
27	872393	1	• Driveshaft		
28	872403	1	• Washer		Included in gasket kit.
29	872174	1	• Lock screw		
30	872172	1	• Thrust ring		
31	876638	1	• Zinc anode kit		
32	963684	2	• • Screw		
33	3851335	1	• Propeller nut		FRONT, (872760)
34	872179	1	• Propeller nut		REAR
35	814482	1	• Oil pump screen		
36	925256	1	O-ring		Included in gasket kit.. Included in complete drive.
37	959457	4	Screw		Included in complete drive.
38	853095	4	Washer		Included in complete drive.
39	854553	1	Splined sleeve		Included in complete drive.
			Bulletin P-44-1-6	P-44-1-6-EN	Lower Gear Unit
40	876267	1	Gasket kit		