

D4-210A-A, D4-210I-A, D4-260A-A, D4-260I-A

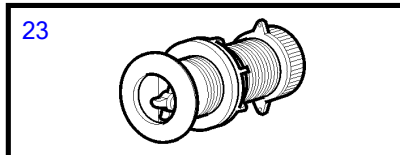
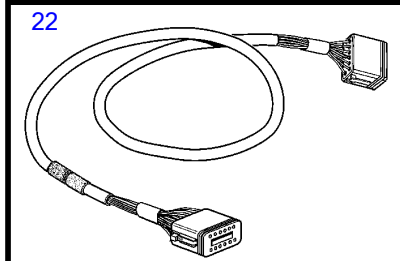
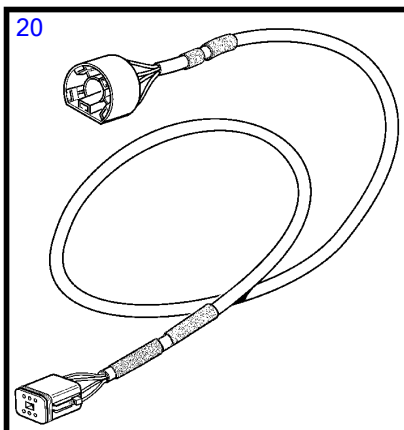
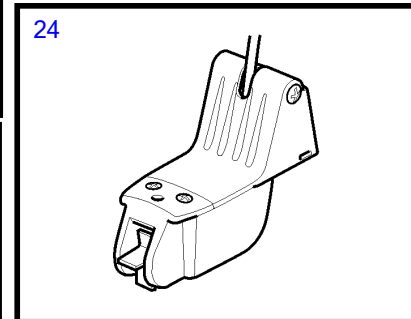
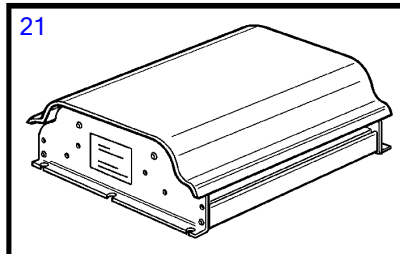
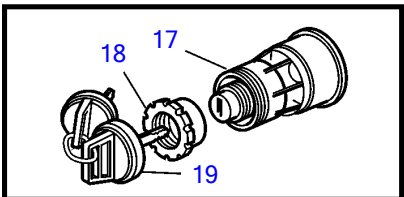
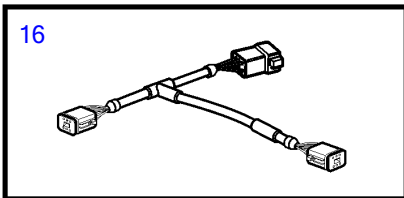
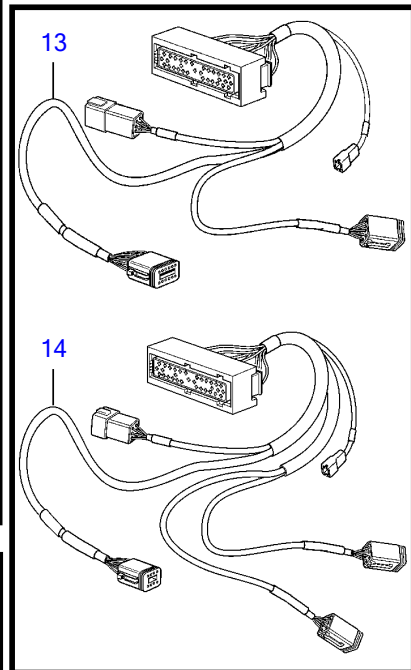
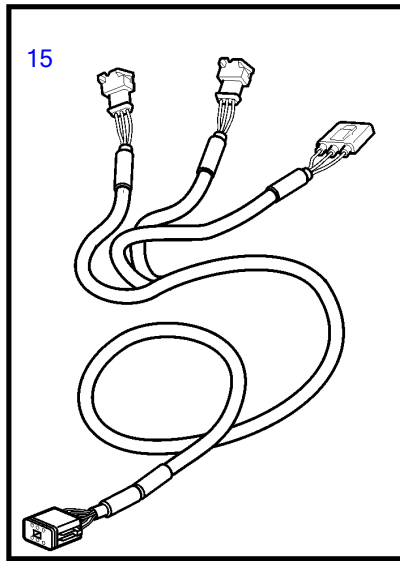
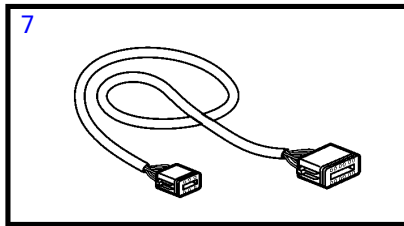
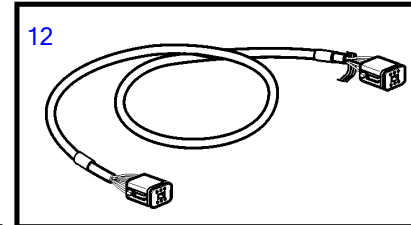
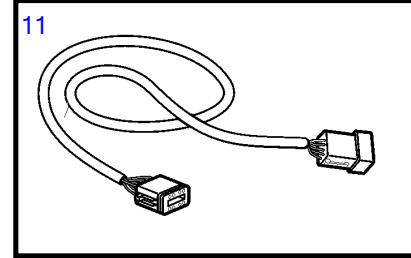
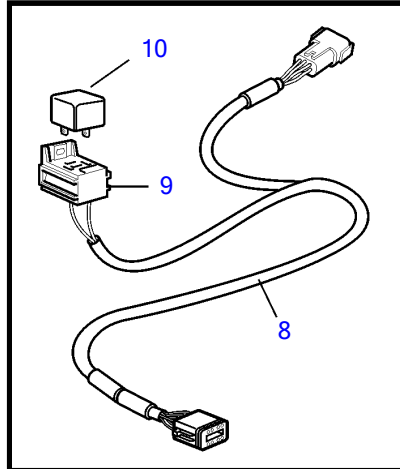
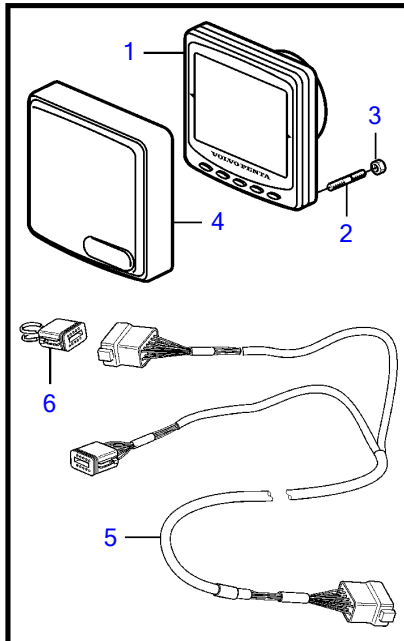

24751

D4-210A-A, D4-210I-A, D4-260A-A, D4-260I-A

REF	PART NO.	QTY	DESCRIPTION	SEE SEC.	NOTES
1	3807827	1	Display		(3587933)
2	830928	4	• Stud		
3	830930	4	• Nut		
4	(830929)	1	• Cardboard tube		Obsolete part
5	881785	1	• Cable kit		
6	881829	1	Resistor		
7	874414	1	Extension cable\verl		Extension cable, 8-pole HCU-EVC control panel.
8	881786	1	Cable kit		
9	977184	1	Housing		
10	873765	1	Relay		12V
	20374662	1	Relay		24V
11	3889410	1	Extension cable\verl		L=1.5m, (874752)
	3842733	1	Extension cable\verl		L=3.0m
	3842734	1	Extension cable\verl		L=5.0m
	3842735	1	Extension cable\verl		L=7.0m
	3842736	1	Extension cable\verl		L=9.0m
	3842737	1	Extension cable\verl		L=11m
12	874789	1	Cable kit		PCU-HCU, 6 pole, L=5.0m
	889550	1	Cable		PCU-HCU, 6 pole, L=7.0m
	889551	1	Cable		PCU-HCU, 6 pole, L=9.0m
	889552	1	Cable		PCU-HCU, 6 pole, L=11m
	888013	1	Cable		PCU-HCU, 6 pole, L=13m
13	21122603	1	Cable		Inboard, Engine-PCU cable., L=3.0m
	21122605	1	Cable		Inboard, Engine-PCU cable., L=5m, (3801224)
14	3808576	1	Wiring harness		AQ, Engine-PCU cable., L=3.0m
	3808577	1	Wiring harness		AQ, Engine-PCU cable., L=4.65m, (874819)
15	874676	1	Cable kit		EVC control lever cable, 6-pole., L=1.5m
16	3588972	1	Cable kit		T-connector bus cable, 6-pole., L=0.5m
17	3587070	1	Starter switch		Kit with 2 key switch with identical key.
	3587071	1	Starter switch		
18	859955	1	• Plastic nut		
19	859953	1	• Key		State key code when ordering.
			• Bulletin 49-30	49-30-EN	Key P/N 859953
20	881849	1	Wiring harness, starter switch		L=1,0m
21	888006	X	Control unit, not programmed		HCU. Software ordered separately or downloaded with Vodia.
	3586261	X	Software		Warehouse programming. This p/n can not be ordered, but will be used for invoicing.
	3586259	X	Software		Vodia-programming. This p/n can not be ordered, but will be used for invoicing.
	3586778	X	Control unit, not programmed		PCU. Software ordered separately or downloaded with Vodia.
	3586267	X	Software		Warehouse programming. This p/n can not be ordered, but will be used for invoicing.
	3586266	X	Software		Vodia-programming. This p/n can not be ordered, but will be used for invoicing.
22	874785	1	Cable kit		Synchronizing cabel for twin installation. 12 pole.
23	3587054	1	Sensor		Through hull
24	3587055	1	Sensor		Mounted on transom