

D3-110i-A, D3-130i-A, D3-160i-A, D3-130A-A, D3-160A-A

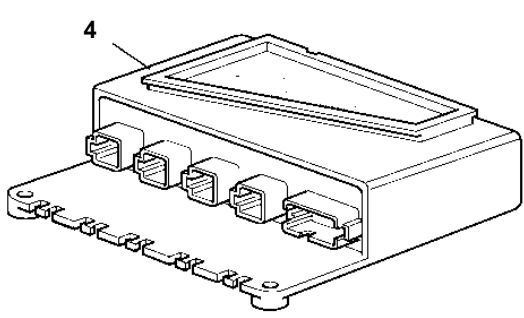
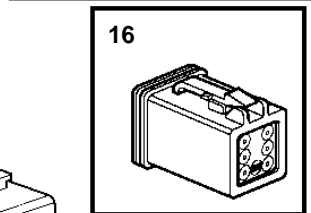
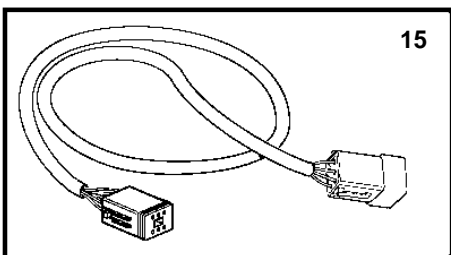
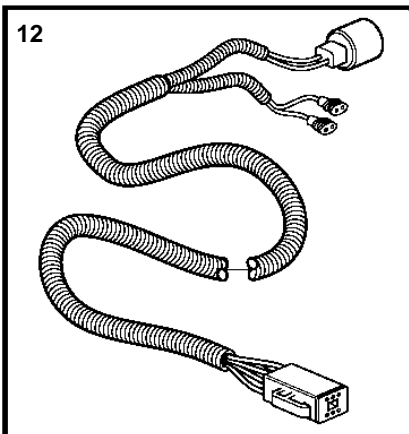
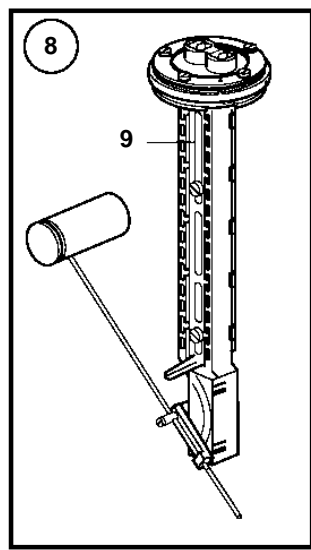
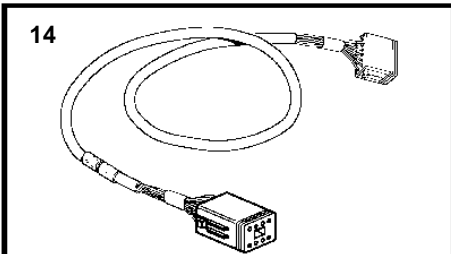
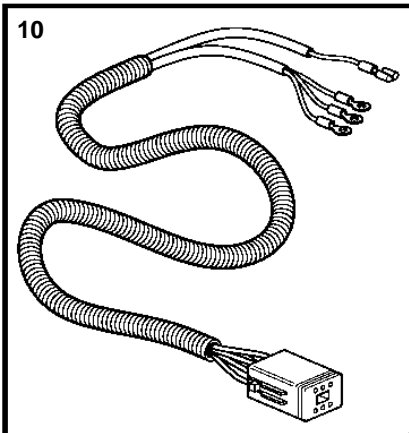
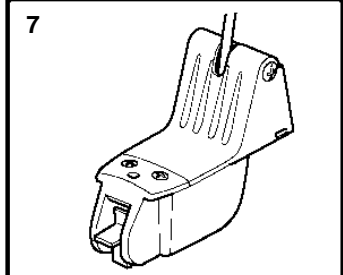
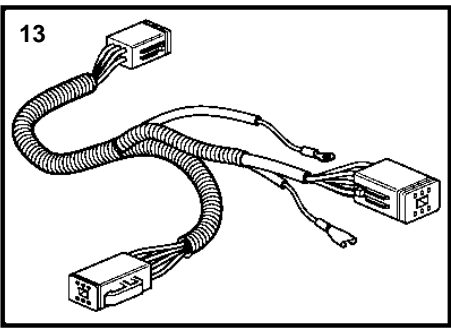
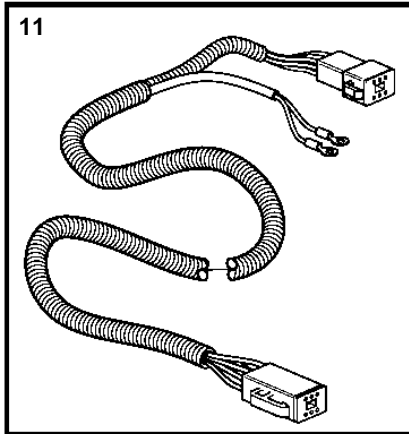
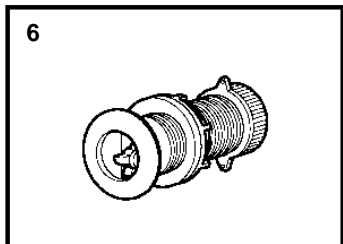
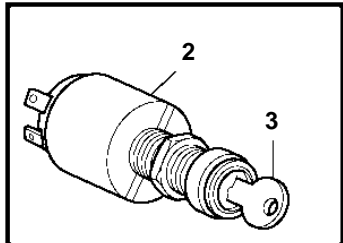
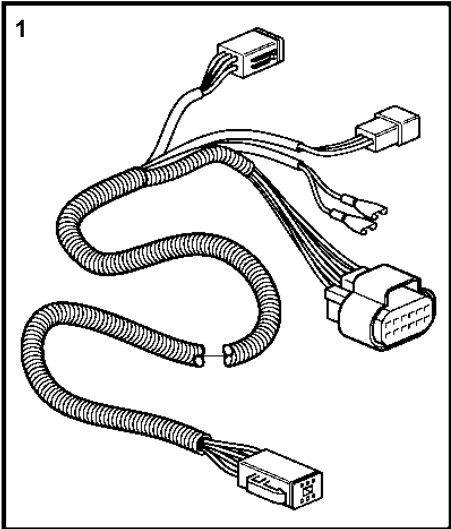
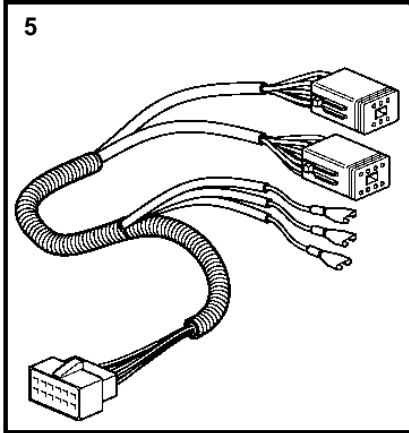

19944

D3-110i-A, D3-130i-A, D3-160i-A, D3-130A-A, D3-160A-A

REF	PART NO.	QTY	DESCRIPTION	SEE SEC.	NOTES
1	881801	1	Cable harness		L=2,0m. Included in EVC cabel kit 3587052.
2	856659	1	Starter switch		
			Bulletin 42-35	42-35-EN	Ignition Switch (P/N 856659-8)
3		1	· Key		State key code when ordering.
4	3807345	1	Control unit, hiu		HIU. For SX Drive.
	3807347	1	Control unit, hiu		HIU. For reverse gear
5	881800	1	Cable harness		ECU to Engine. Included in EVC cabel kit 3587052.
6	3587054	1	Sender		
7	3587055	1	Sender		
8	874840	1	Sender		
9	873772	1	· Tank sensor		
10	881803	1	Cable harness		L=0,5m. For Trim instrument and Instrument light. Included in EVC cabel kit 3587052.
11	881802	1	Cable		L=5,0m. For fuel level sender
12	881804	1	Cable harness		L=5,0m. For trim pump and trim sender. Included in EVC cabel kit 3587052.
13	881805	1	Cable		L=0,5m
14	888248	1	Cable		L=3,0m
	888249	1	Cable		L=5,0m
	888250	1	Cable		L=7,0m
	888251	1	Cable		L=9,0m
	888253	1	Cable		L=11,0m
15	888243	1	Cable		L=3,0m
	888244	1	Cable		L=5,0m
	888245	1	Cable		L=7,0m
	888246	1	Cable		L=9,0m
	3842737	1	Extension cable\verl		L=11,0m
16	3840433	1	Plug		Plug for connection in HIU when reverse gear is used.