

TAMD120B

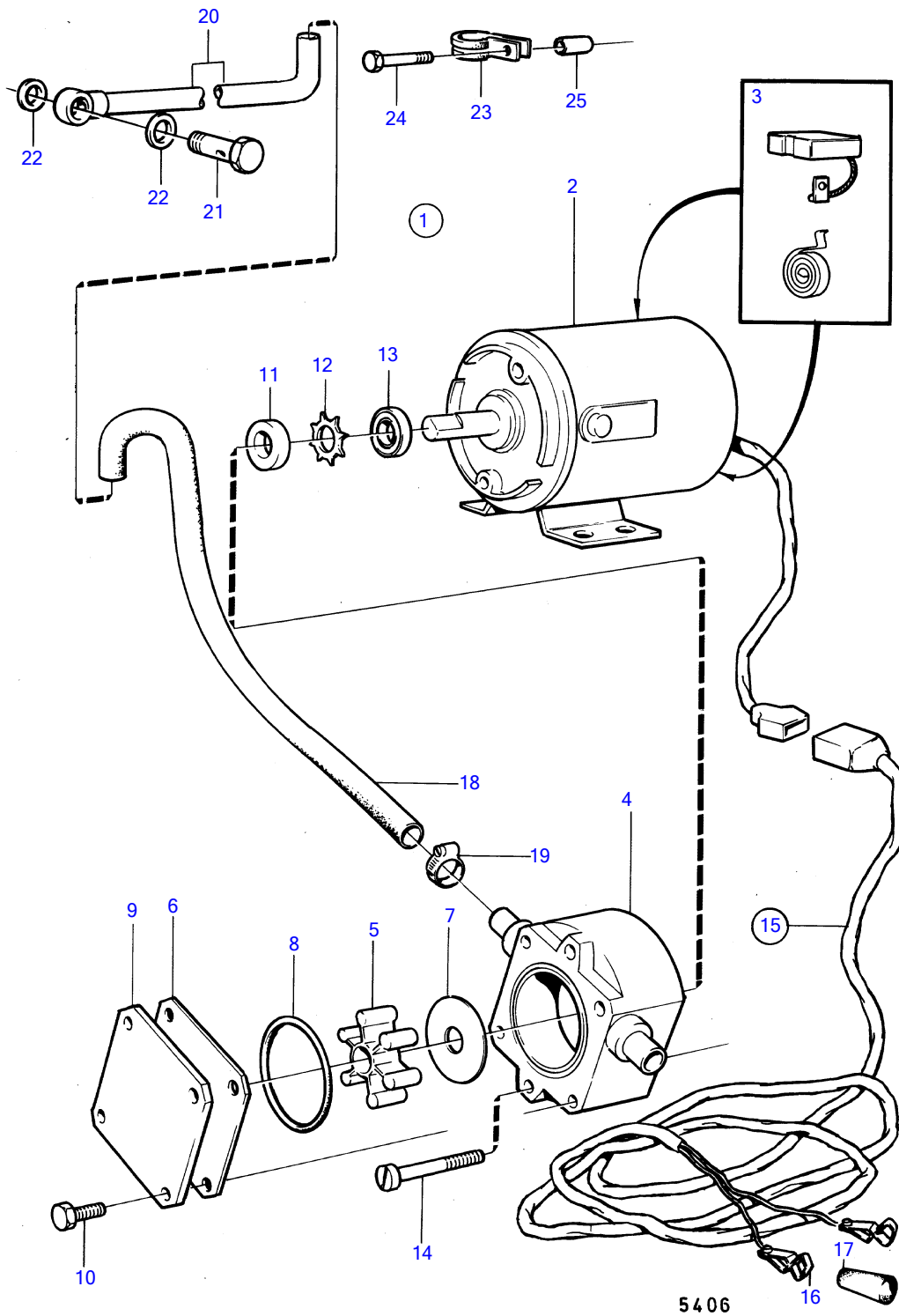

TAMD120B

REF	PART NO.	QTY	DESCRIPTION	NOTES
1	843114	1	Oil bilge pump	12V
2		1	• el.motor	
3	(844014)	2	• Carbon brush set	Obsolete part
4	(844015)	1	• Pump housing	Obsolete part
5	844022	1	• Impeller kit	
6	844017	1	• Wear washer	
7	844016	1	• Wear washer	
8		1	• o-ring	
9	844018	1	• Cardboard tube	
10	844021	4	• Screw	
11		1	• seal ring	
12		1	• lock washer	
13	844019	1	• Deflector ring	
14	844020	2	• Screw	
15	843113	1	• Cable trunk	
16	844280	2	• • Clip	
17	(844279)	1	• • Isolation	Black, Obsolete part
	(844278)	1	• • Isolation	Red, Obsolete part
18	943707	X	• Hose	L=3000mm
19	943471	3	• Hose clamp	
20	844870	1	Oil scavenging pipe	
21	26013	1	Hollow screw	
22	957181	2	Gasket	
23	941950	1	Clamp	
24	940161	1	Hexagon screw	
25	807182	1	Spacer sleeve	