

KAD42A, KAMD42A

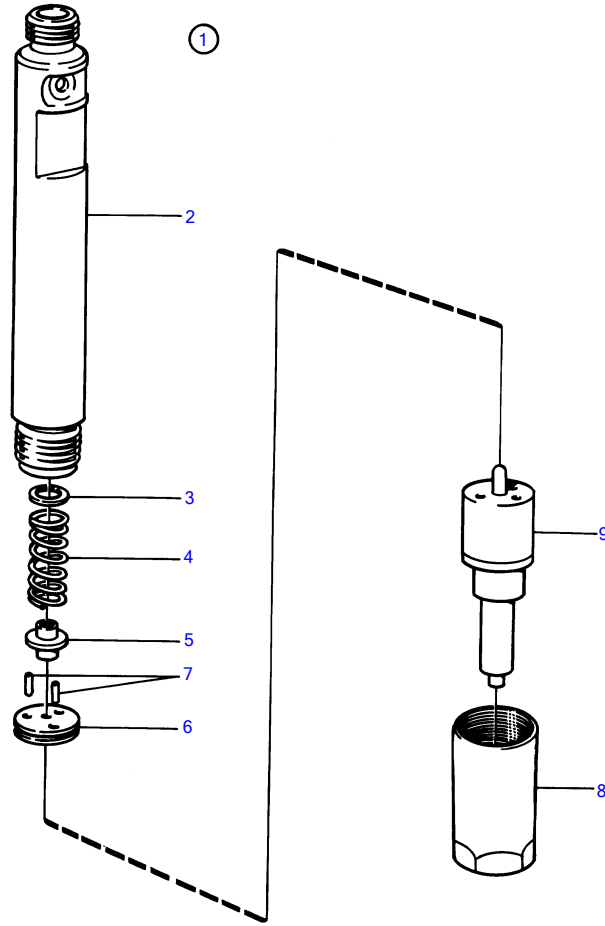

8353

KAD42A, KAMD42A

REF	PART NO.	QTY	DESCRIPTION	NOTES
1	861103	1	Injector	
	3803238	1	Injector, exch, exch	
2		1	• nozzle holder	
3	243467	X	• • Adjusting washer	TH=1.00mm
	243468	X	• • Adjusting washer	TH=1.05mm
	6885721	X	• • Shim	TH=1.08mm
	243469	X	• • Adjusting washer	TH=1.10mm
	243470	X	• • Adjusting washer	TH=1.15mm
	243471	X	• • Adjusting washer	TH=1,20mm
	243472	X	• • Adjusting washer	TH=1,25mm
	6885724	X	• • Shim	TH=1,28mm
	243473	X	• • Adjusting washer	TH=1,30mm
	243474	X	• • Adjusting washer	TH=1,35mm
	243475	X	• • Adjusting washer	TH=1,40mm
	243476	X	• • Adjusting washer	TH=1,45mm
	6885727	X	• • Shim	TH=1,48mm
	243477	X	• • Adjusting washer	TH=1,50mm
	243478	X	• • Adjusting washer	TH=1,55mm
	243479	X	• • Adjusting washer	TH=1,60mm
	243480	X	• • Adjusting washer	TH=1,65mm
	6885730	X	• • Shim	TH=1,68mm
	243481	X	• • Adjusting washer	TH=1,70mm
	243482	X	• • Adjusting washer	TH=1,75mm
	243483	X	• • Adjusting washer	TH=1,80mm
	6885739	X	• • Shim	TH=1,84mm
	6885740	X	• • Shim	TH=1,88mm
	243485	X	• • Adjusting washer	TH=1,90mm
	243486	X	• • Adjusting washer	TH=1,95mm
4	6885720	1	• • Compression spring	
5		1	• • bolt	
6		1	• • washer	
7	244907	2	• • Locating pin	
8	243489	1	• • Nut	
9	861117	1	• Nozzle	