

D65A-MT, D65A-MS

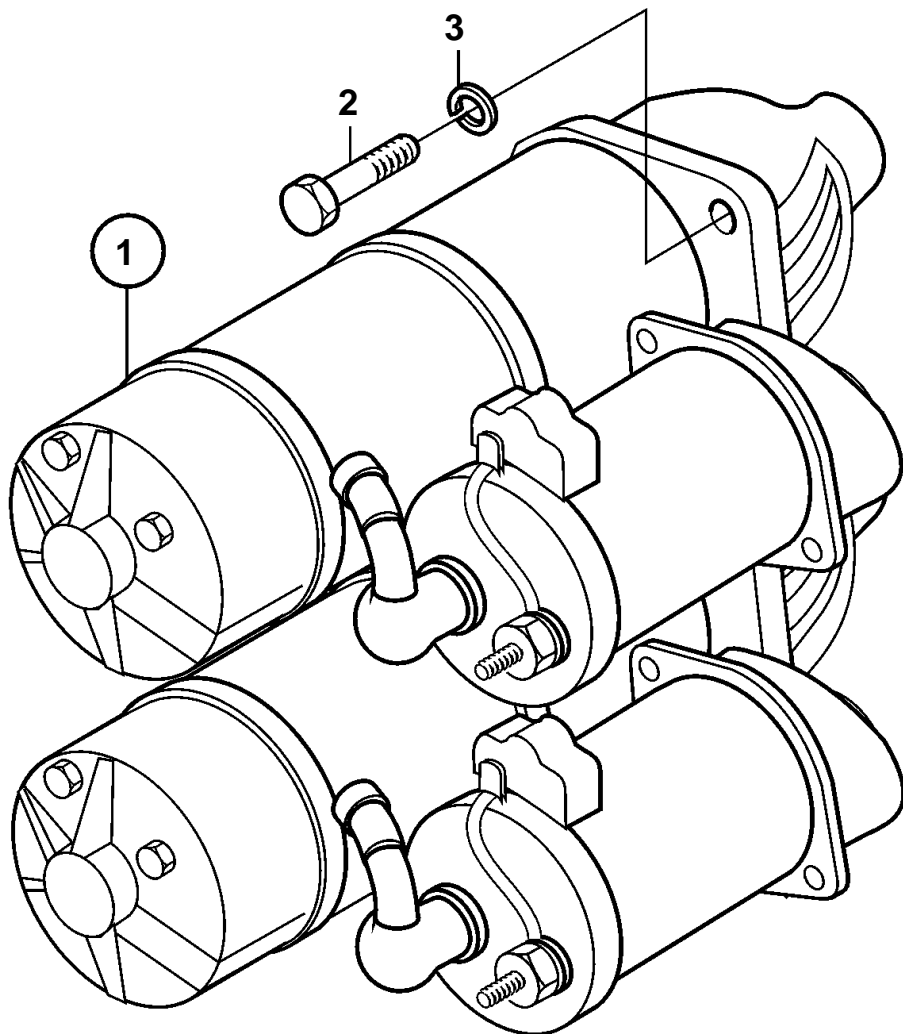

D65A-MT, D65A-MS

REF	PART NO.	QTY	DESCRIPTION	SEE SEC.
1	3835776	2	Starter motor	
				4997
2	3832063	6	Screw	
3	3832245	6	Spring washer	