

D65A-MT, D65A-MS

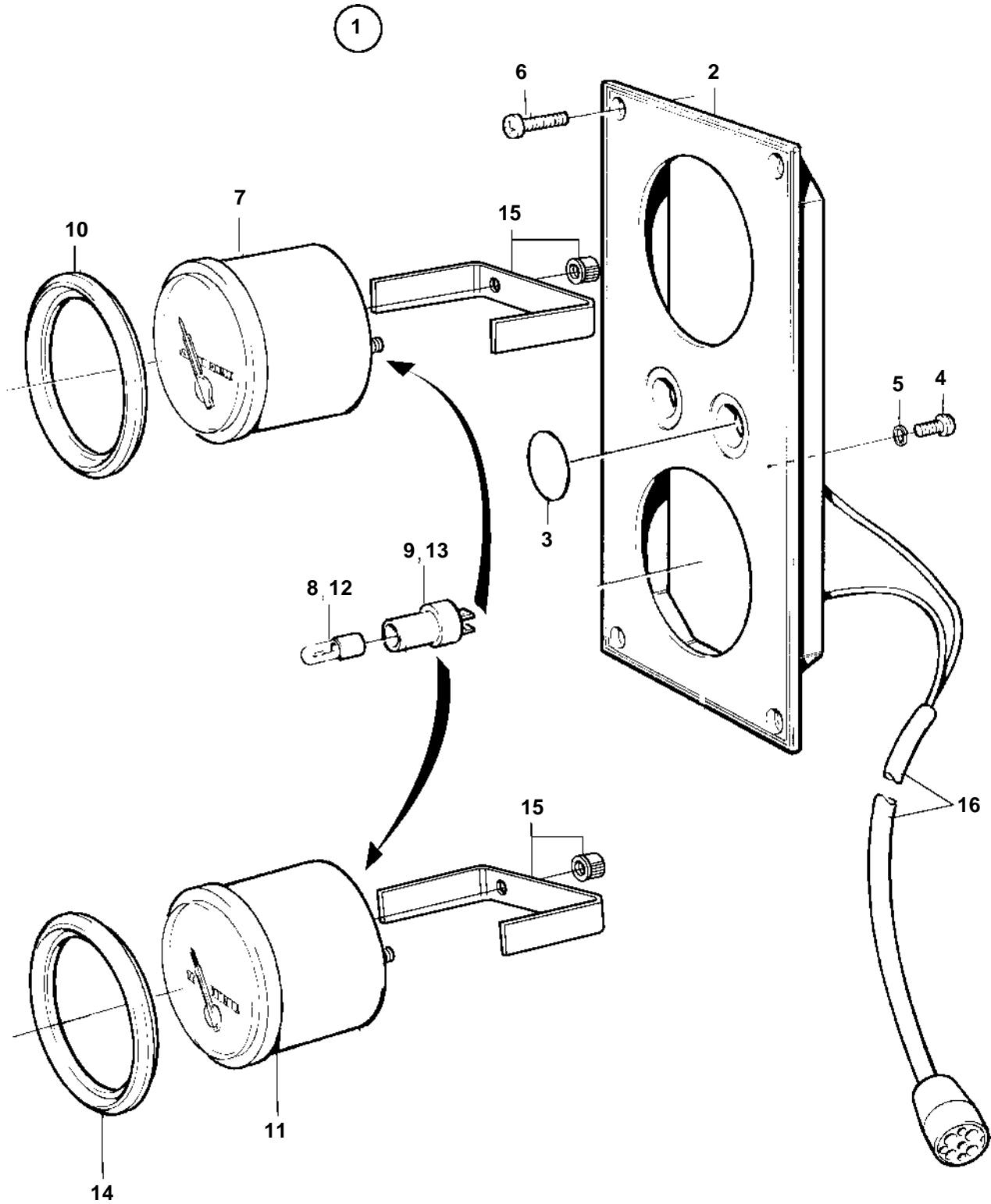

D65A-MT, D65A-MS

REF	PART NO.	QTY	DESCRIPTION	SEE SEC.	NOTES
1	864053	1	Instrument panel		
2		1	· Instrument panel		
3	828607	2	· · Cover plate		
4	949947	1	· · Screw		
5	941904	1	· · Spring washer		
6	828647	4	· · Screw		
7	873202	1	· Oil pressure gauge		
8	863947	1	· · Bulb		RED, 24V, 1,2W W2x4,6d. Withe bulb 943638 can be mounted in bulb socket 863945.
9	863945	1	· · Bulb socket		
10	858643	1	· Front ring		
11	873206	1	· Turbo pressure gauge		
12	863947	1	· · Bulb		RED, 24V, 1,2W W2x4,6d. Withe bulb 943638 can be mounted in bulb socket 863945.
13	863945	1	· · Bulb socket		
14	858643	1	· Front ring		
15	873207	2	· Retainer		
16		1	· Cable trunkElectrical materials	1963	Turbocharge-reverse gear.