

D65A-MT AUX, D65A-MS AUX

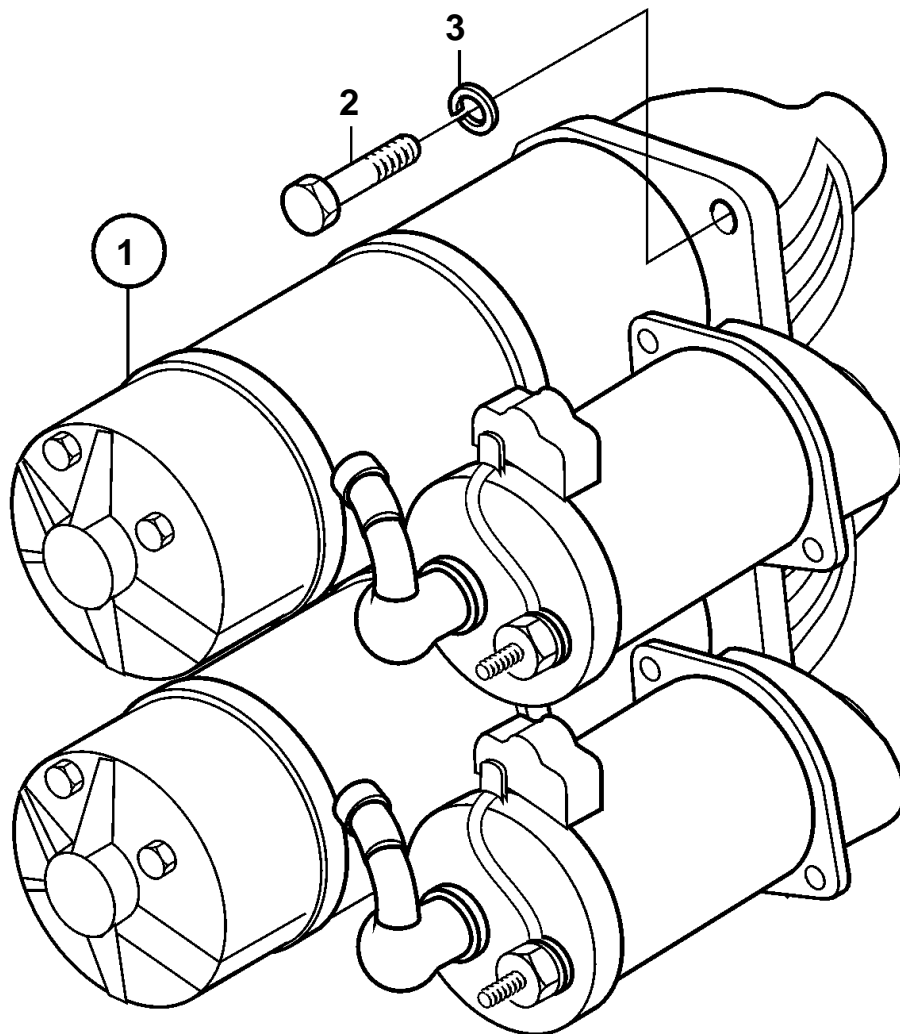

D65A-MT AUX, D65A-MS AUX

REF	PART NO.	QTY	DESCRIPTION	SEE SEC.
1	3835776	2	Starter motor	
				4997
2	3832063	6	Screw	
3	3832245	6	Spring washer	