

D65A-MT AUX, D65A-MS AUX

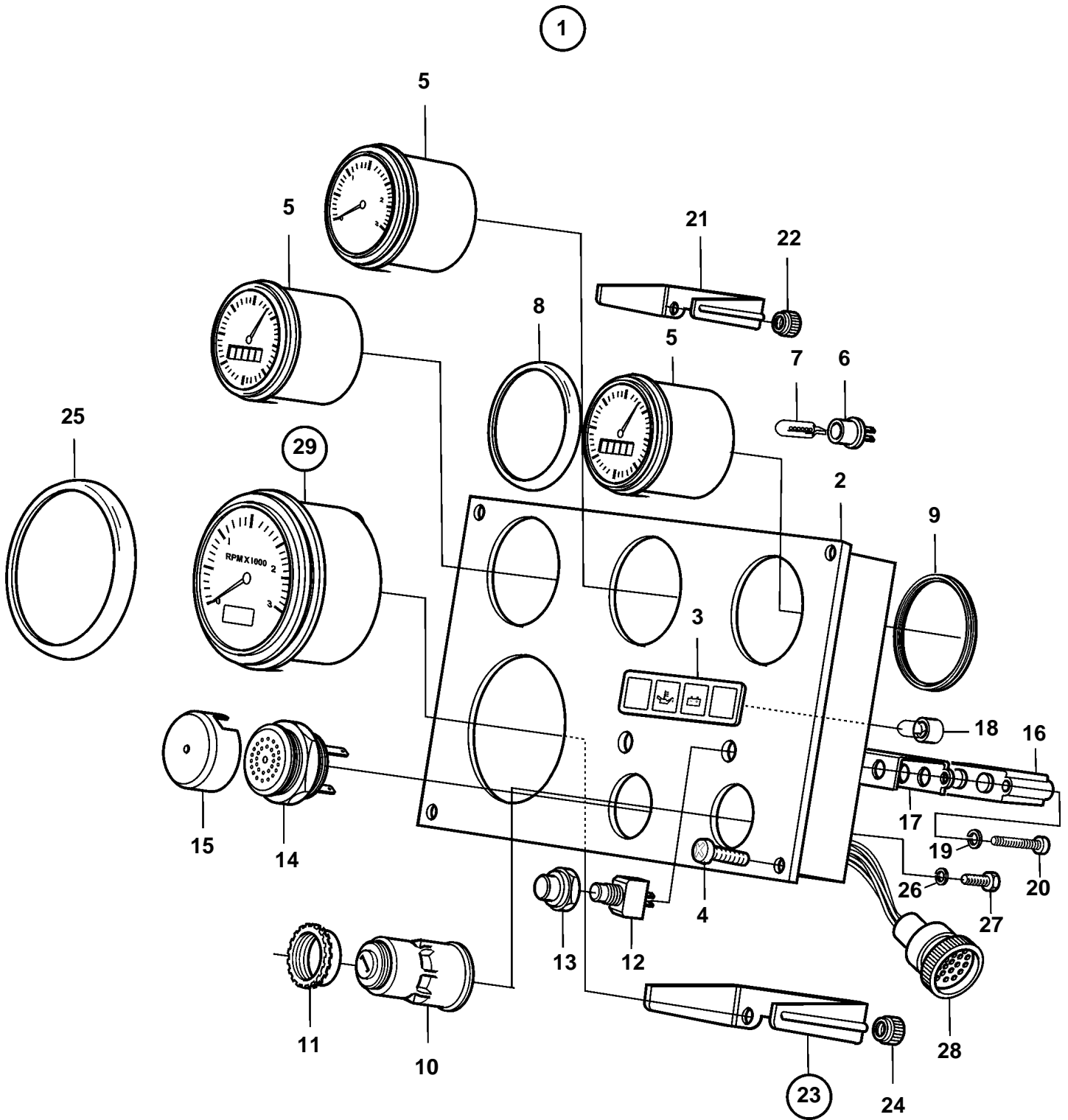

20806

D65A-MT AUX, D65A-MS AUX

REF	PART NO.	QTY	DESCRIPTION	NOTES
1	3587075	1	Instrument panel	
2		1	· Instrument panel	
3	858645	1	· Symbol strip	
4	828647	4	· Screw	
5	873196	1	· Temperature gauge	
	873198	1	· Oil pressure gauge	
	873200	1	· Voltmeter	
6	863945	3	· · Bulb socket	
7	863947	3	· · Bulb	
8	858643	3	· Front ring	D=52mm
9	828803	3	· Ring	
10		1	· Starter switch	
11	859955	1	· Plastic nut	
12	828584	1	· Switch	TEST ALARM
	828585	1	· Switch	INSTR. LIGHT
13	828586	2	· Nut	
14	828587	1	· Buzzer	
15	858795	1	· Protecting casing	
16	873737	1	· Electronic unit	(873209)
17	828784	1	· Reflector	
18	828818	4	· Bulb	24V
19	941904	2	· Spring washer	
20	941615	2	· Screw	
21	873207	3	· Retainer	
22		6	· · Nut	
23	873208	1	· Retainer	
24		2	· · Nut	
25	873517	1	· Front ring	D=72mm
26	941904	1	· Spring washer	
27	949947	1	· Screw	
28	828646	1	· Cable trunk	
29		1	Tachometer	