

D5A-A T, D5A-A TA, D5A-B TA, D5A-B TA, D5A-B TA

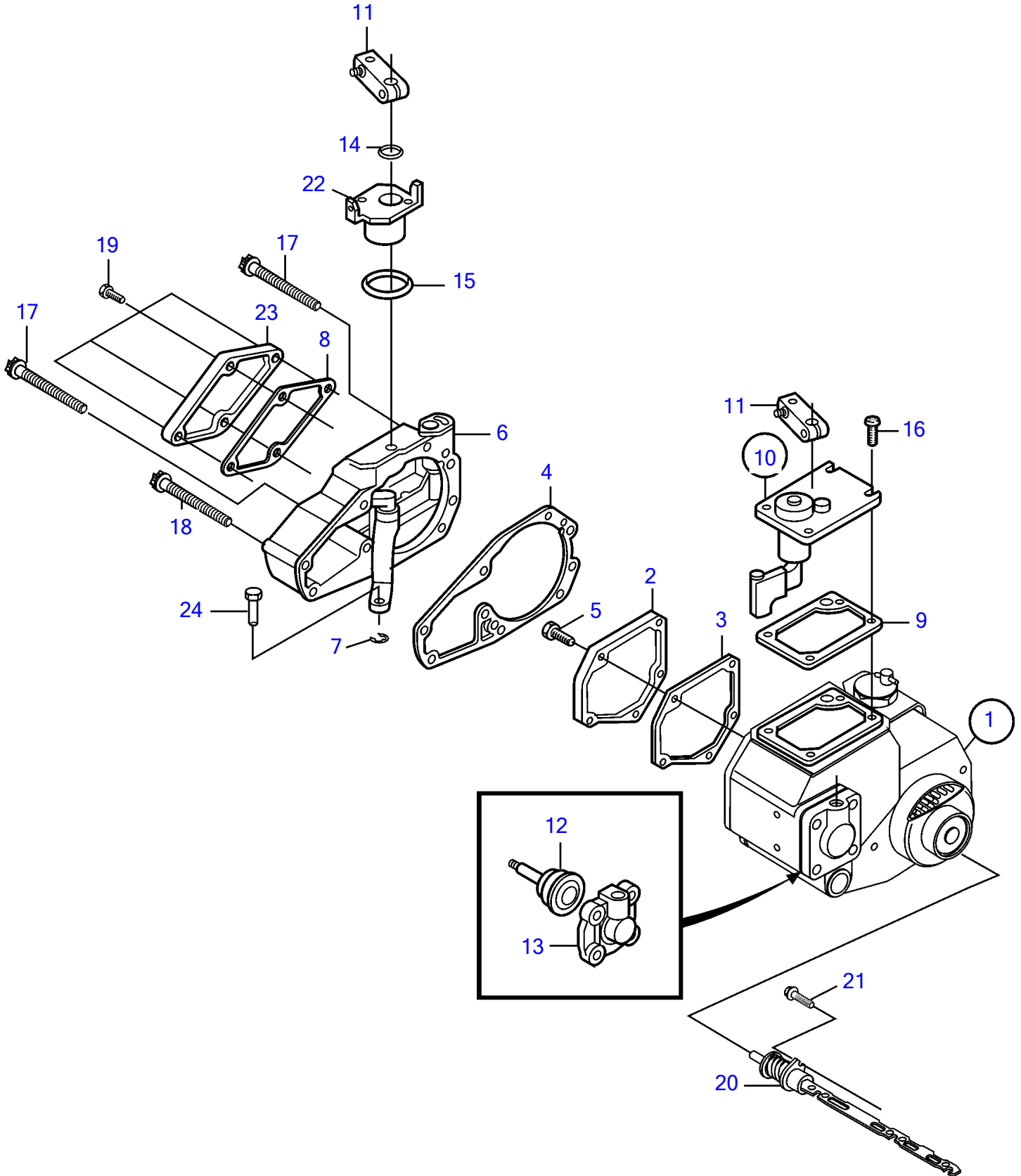

D5A-A T, D5A-A TA, D5A-B TA, D5A-B TA, D5A-B TA

REF	PART NO.	QTY	DESCRIPTION	NOTES
1	20590563	1	Governor	When ordering a regulator as a spare part always state engine types, serialnumber, rated power and rated speed (rpm).
2		1	• Hood	
3	20405508	1	• Gasket	
4	20405510	1	• Gasket	
5	20460068	1	• Lock screw	
6		1	• Housing	
7		1	• Washer	
8	20405509	1	• Gasket	
9	20405507	1	• Gasket	
10	20412752	1	• Cover	
11	3588182	2	• • Lever extension	
12		1	• Piston	
13		1	• Cover	
14		1	• Ring	
15		1	• Ring	
16	20460067	1	Lock screw	Only use locking screw in case of repair. Locking screw can only be used once.
17	20460064	4	Six point screw	
18	888760	1	Six point screw	
19	20460082	4	Screw	
20	20405867	1	Control rod	
21	946173	1	Flange screw	Prepared with locking fluid., (20405538)
22		1	Stop lug	
23		1	Lock	
24		1	Pin	