

TAMD41A

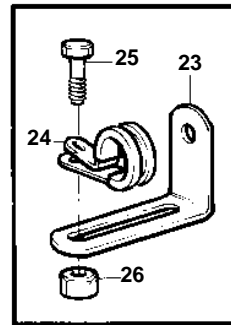
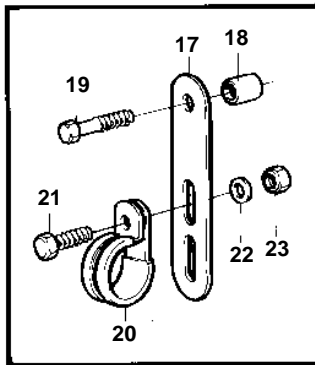
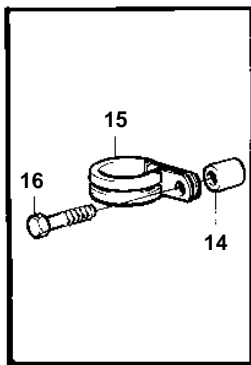
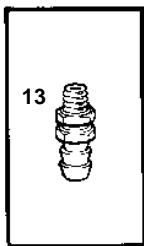
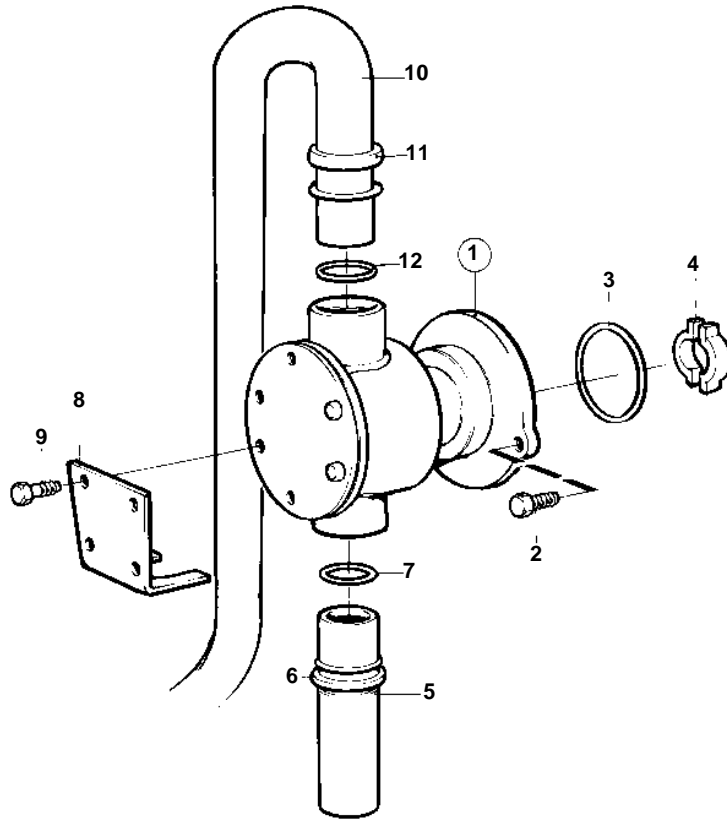

9127

TAMD41A

REF	PART NO.	QTY	DESCRIPTION	SEE SEC.	NOTES
1	858701	1	Sea water pump		
				02B-1270	
2	946173	2	Flange screw		
3	968971	1	O-ring		
4	858467	1	Companion flange		
5	858522	1	Tube		INLET-WATER PUMP
6	847108	1	Retainer		
7	949658	1	O-ring		
8	847107	2	Lock brace		
9	963545	4	Screw		
10	838971	1	Tube		WATER PUMP-OIL COOLER
11	847108	1	Retainer		
12	949658	1	O-ring		
13	949918	1	Drain cock		
14	846339	1	Spacer sleeve		
15	947827	1	Clamp		
16	965180	1	Flange screw		
17	965534	1	Bracket		
18	843075	1	Sleeve		
19	965182	1	Flange screw		
20	952635	1	Clamp		
21	946544	1	Flange screw		
22	945407	1	Flange nut		
23	965537	1	Bracket		
24	952635	1	Clamp		
25	946544	1	Flange screw		
26	945407	1	Flange nut		