

AQAD41A

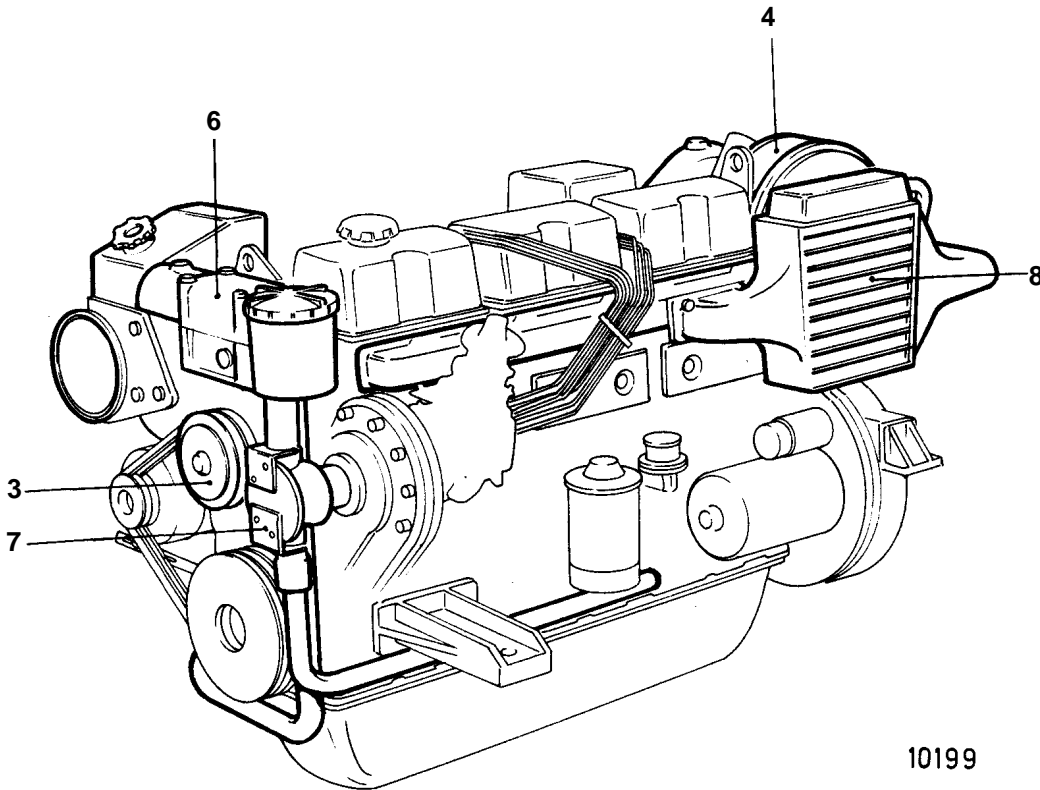
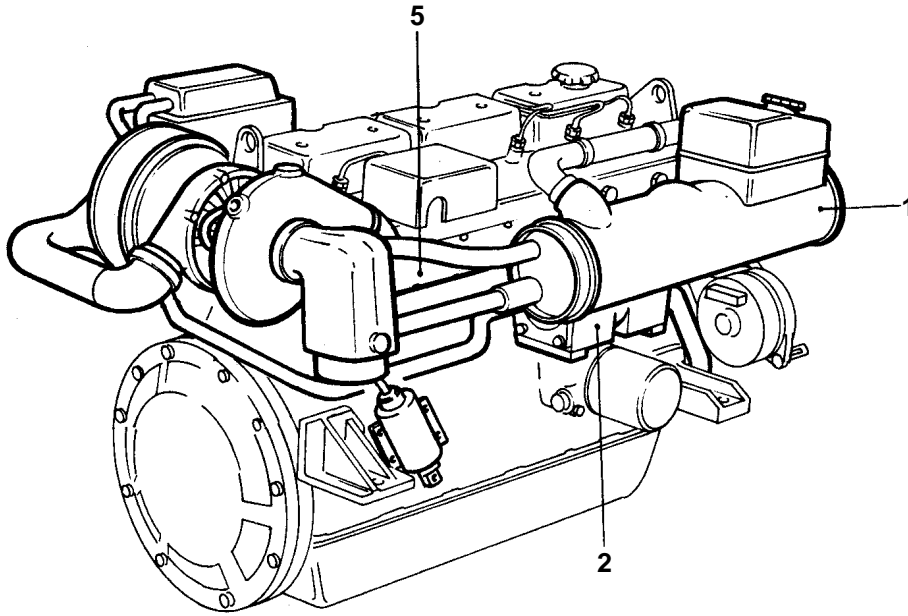

10199

AQAD41A

REF	QTY	DESCRIPTION	SEE SEC.
1	1	HEAT EXCHANGER WITH INSTALLATION COMPONENTS	02B-0873
2	1	OIL COOLER WITH INSTALLATION COMPONENTS	02B-1292
3	1	CIRCULATION PUMP WITH INSTALLATION COMPONENTS	02B-1000
4	1	TURBO AND AIR FILTER WITH INSTALLATION COMPONENTS	02B-2050
5	1	INDUCTION- AND EXHAUST MANIFOLD WITH INSTALLATION COMPONENTS	02B-2350
6	1	THERMOSTAT HOUSING WITH INSTALLATION COMPONENTS	02B-2500
7	1	SEAWATER PUMP WITH INSTALLATION COMPONENTS	02B-1140
8	1	AFTER COOLER WITH INSTALLATION COMPONENTS	02B-2400