

D4-260D-F, D4-300D-F

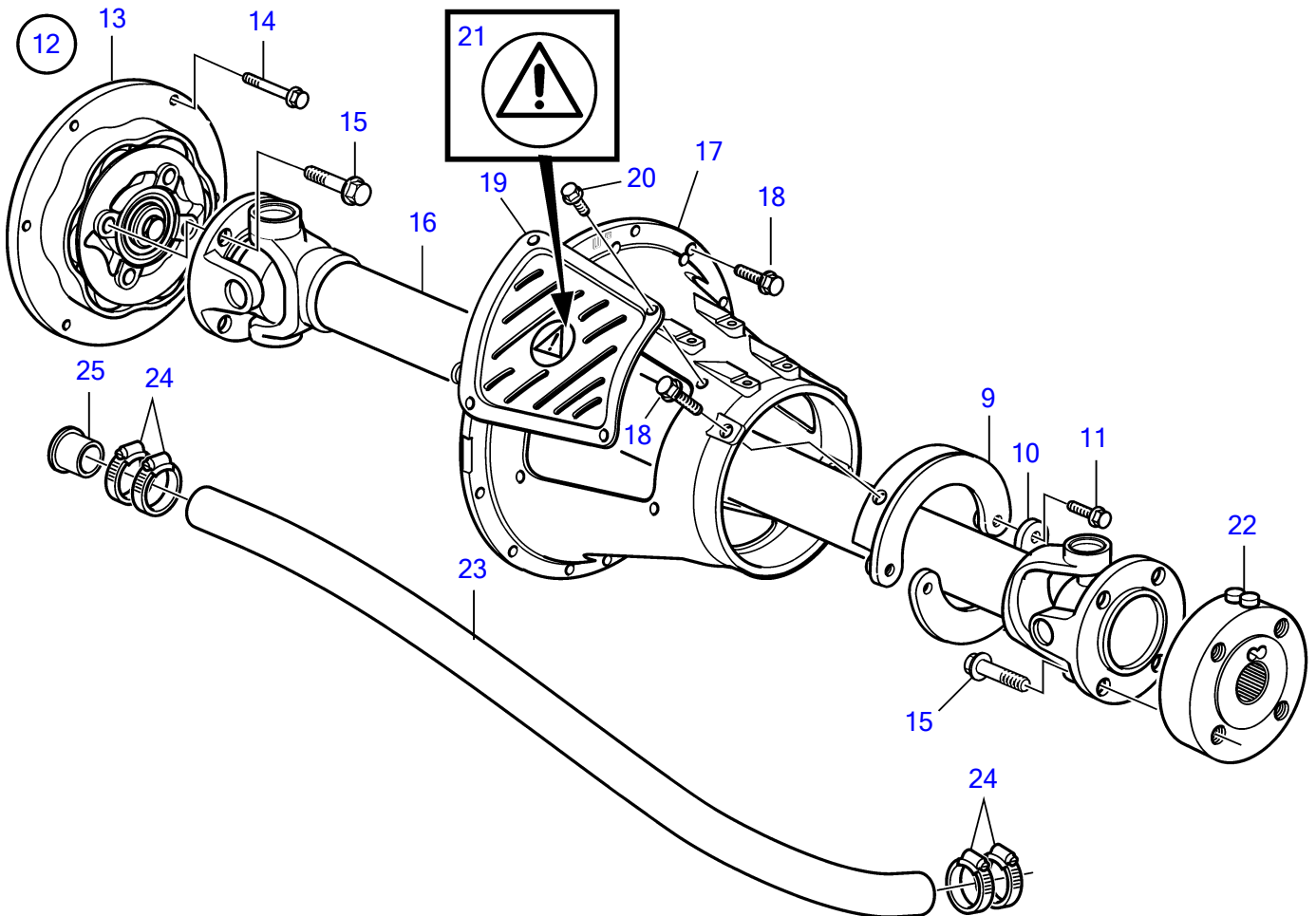
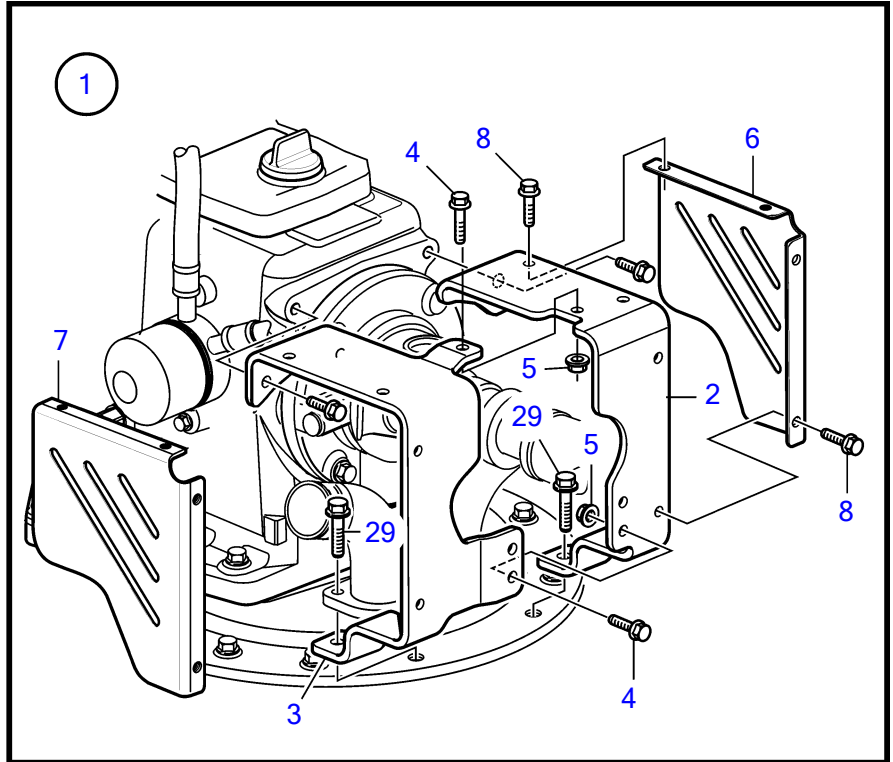
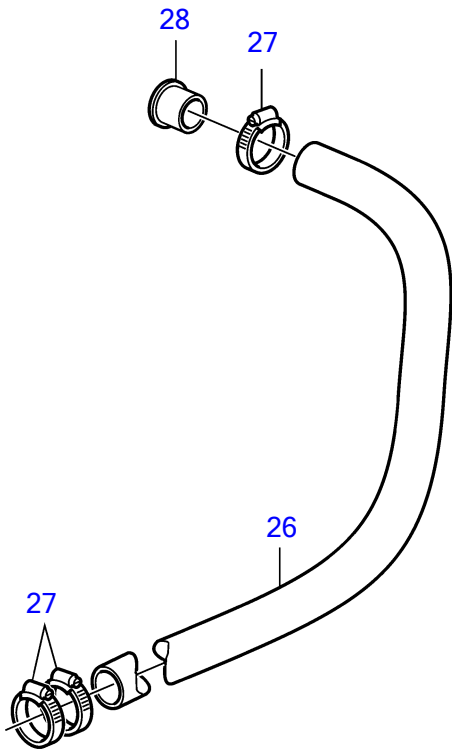

D4-260D-F, D4-300D-F

REF	PART NO.	QTY	DESCRIPTION	NOTES
1		1	Safety catch	
2	3812835	1	▪ Bracket	Port
3	3812812	1	▪ Bracket	Starboard
4	946472	5	▪ Flange screw	
5	971095	3	▪ Flange nut	
6	21496784	1	▪ Cardboard tube	
7	3812863	1	▪ Cardboard tube	
8	946173	8	▪ Flange screw	
9	3594012	1	▪ Safety catch	
10	3817572	1	▪ Plate	
11	946472	2	▪ Flange screw	
12	21393521	1	Flexible coupling	
13	21509615	1	▪ Roller kit	Kit includes 6 pcs rubber rollers
14	965186	8	Flange screw	
15	465826	8	Flange screw	
16	3818295	1	Propeller shaft	L=570-650mm
	3818293	1	Propeller shaft	L=670-750mm
	3818292	1	Propeller shaft	L=770-850mm
	3818291	1	Propeller shaft	L=870-950mm
	3818290	1	Propeller shaft	L=970-1050mm
	3818289	1	Propeller shaft	L=1070-1150mm
	3818288	1	Propeller shaft	L=1170-1250mm
	3817454	1	Propeller shaft	L=1270-1350mm
	3817453	1	Propeller shaft	L=1370-1450mm
	3817452	1	Propeller shaft	L=1470-1550mm
	3817451	1	Propeller shaft	L=1570-1650mm
	3817450	1	Propeller shaft	L=1670-1750mm
17	21657788	1	Protecting casing	
18	946752	12	Flange screw	M10x35mm
19	3862871	2	Protecting screen	
20	968476	8	Flange screw	
21	3817024	2	Decal	
22	3862153	1	Flange	
23	1140670	X	Exhaust hose	
24	961672	4	Hose clamp	
25	3883983	1	Sleeve	Ratio 2.08:1
26	1140670	1	Exhaust hose	Ratio 1.94:1, Ratio 1.82:1
27	961672	3	Hose clamp	Ratio 1.94:1, Ratio 1.82:1
28	3819914	1	Sleeve	Ratio 1.94:1, Ratio 1.82:1
29		2	Screw	