

D34A-MT AUX, D34A-MS AUX

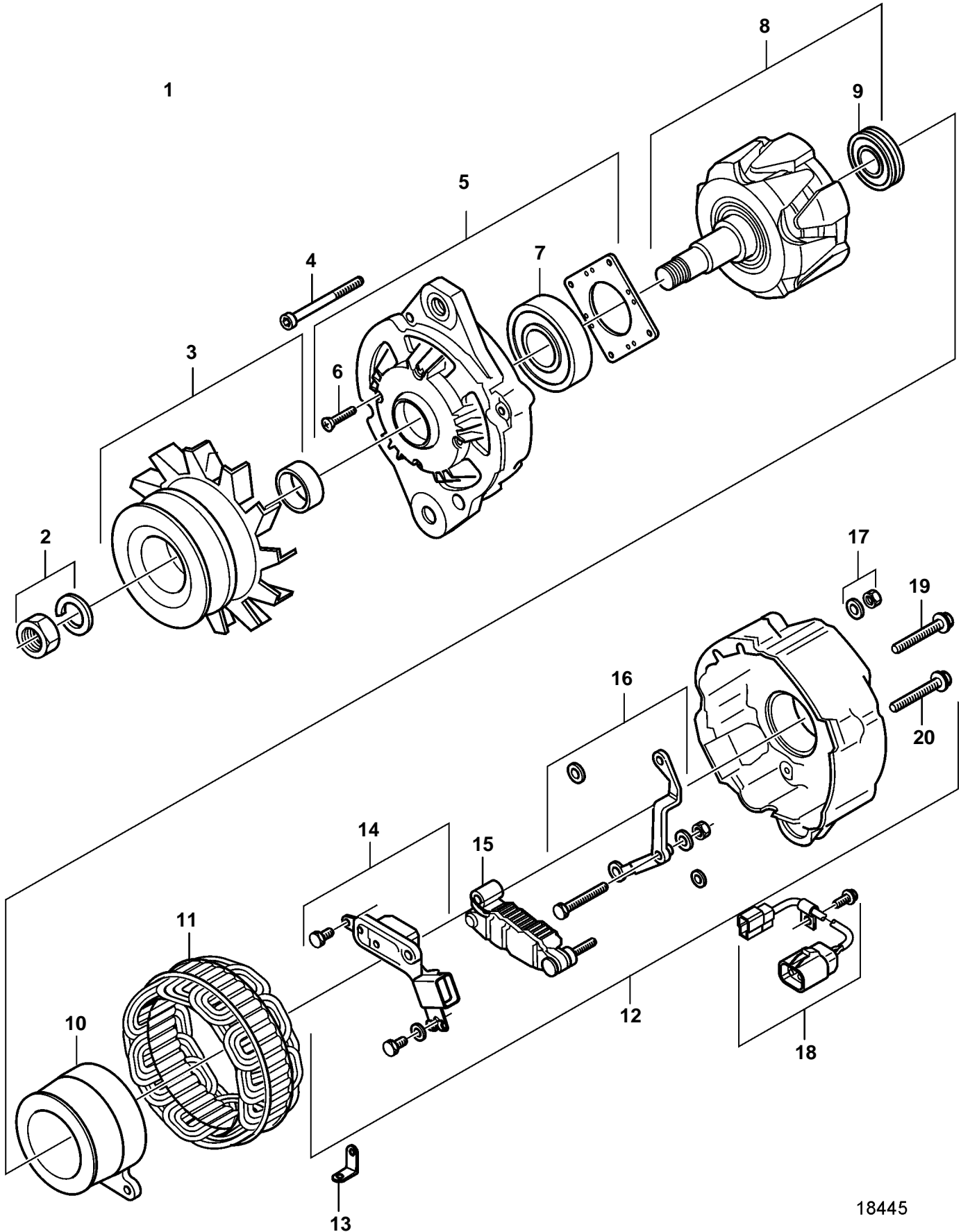

18445

D34A-MT AUX, D34A-MS AUX

REF	PART NO.	QTY	DESCRIPTION
1	3832150	1	Alternator
2	3833813	1	· Nut set
3	3834295	1	· Pulley
4	3834413	1	· Screw
5	3833017	1	· Bracket
6	3834414	1	· · Screw
	3832094	1	· · Bearing
7		1	· · Rotor
8		1	· Rotor
9	3832094	1	· · Bearing
10	3833205	1	· Coil
11		1	· Field winding
12	3833019	1	· Bracket
13	3834219	1	· · Plate
14	3834333	1	· · Regulator kit
15	3834332	1	· · Rectifier
16	3834766	1	· · Pin
17	3833812	1	· · Nut set
18	3833282	1	· Connector kit
19	3834416	1	· Screw
20	3834415	1	· Screw