

D3-110I-E, D3-110I-F, D3-140I-E, D3-140I-F, D3-140A-E, D3-140A-F, D3-150I-E, D3-150I-F, D3-170I-E, D3-170I-F, D3-170A-E, D3-170A-F, D3-200I-E, D3-200I-F, D3-200A-E, D3-200A-F, D3-220I-E, D3-220I-F, D3-220A-E, D3-220A-F

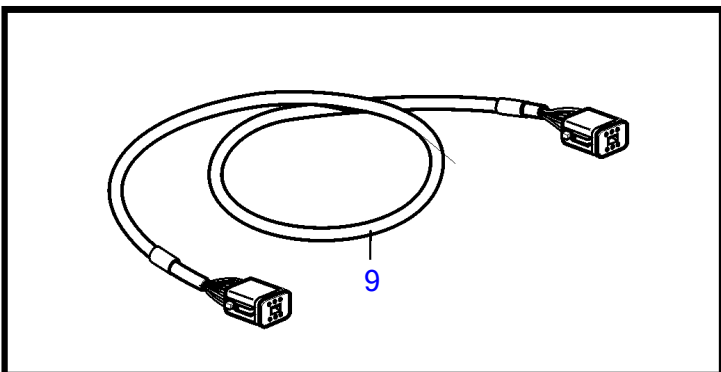
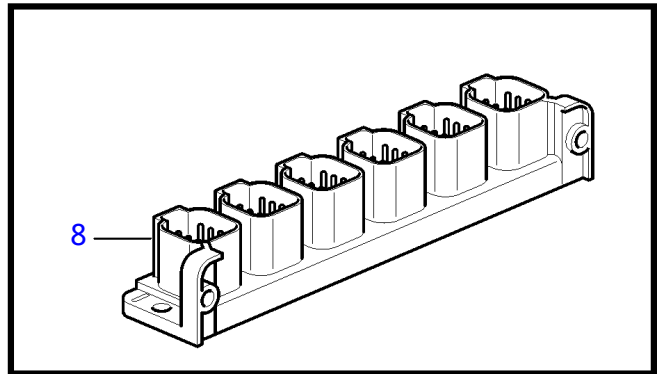
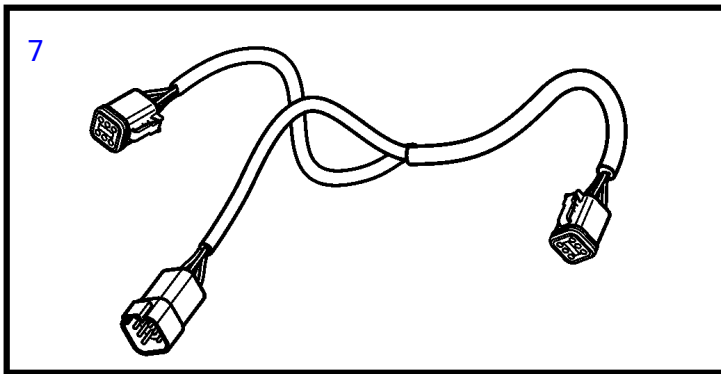
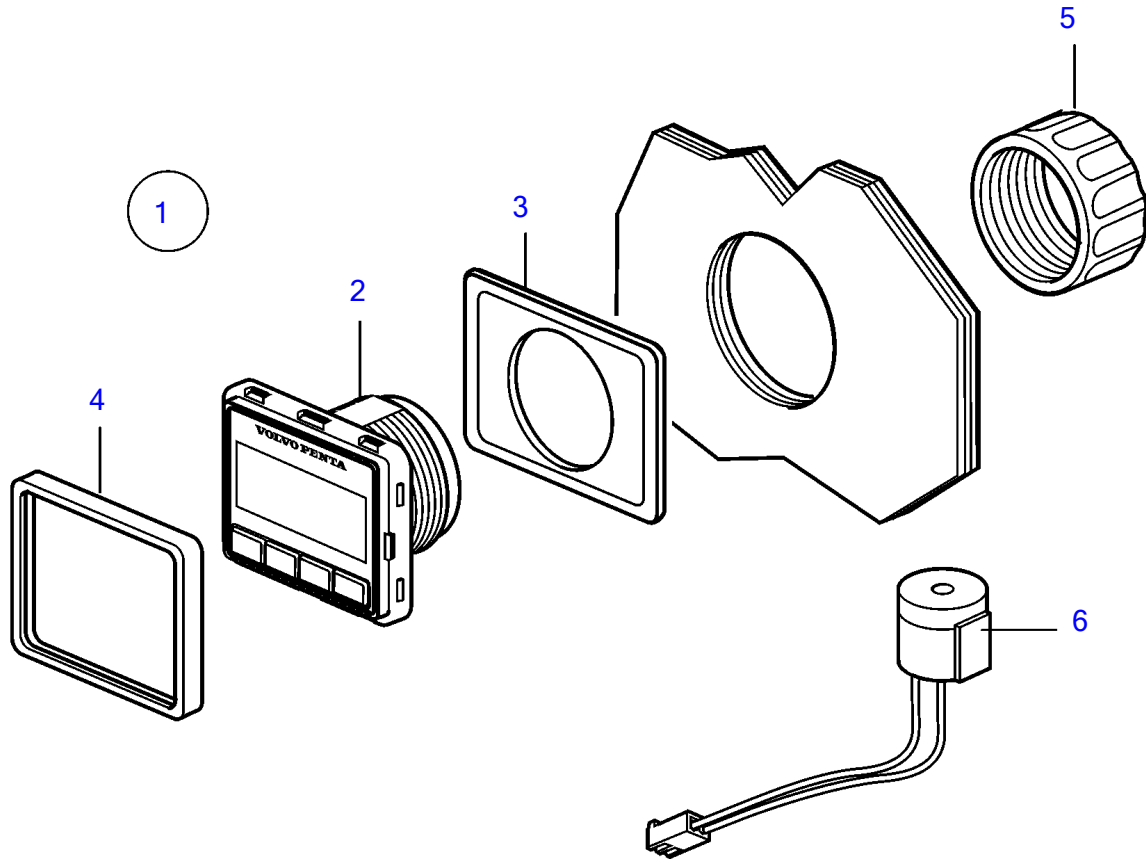

25294

D3-110I-E, D3-110I-F, D3-140I-E, D3-140I-F, D3-140A-E, D3-140A-F, D3-150I-E, D3-150I-F, D3-170I-E, D3-170I-F, D3-170A-E, D3-170A-F, D3-200I-E, D3-200I-F, D3-200A-E, D3-200A-F, D3-220I-E, D3-220I-F, D3-220A-E, D3-220A-F

REF	PART NO.	QTY	DESCRIPTION	NOTES
1	21761722	1	Display	Flexidisplay button panel
2		1	• Display	
3	3808135	1	• Gasket	
4	21467057	1	• Frame	
5	874450	1	• Attaching ring	
6	21358227	1	• Buzzer	
7	3588972	2	Cable kit	
8	21469055	1	Connection block	
9	3886666	6	Cable	