

D12D-B MP

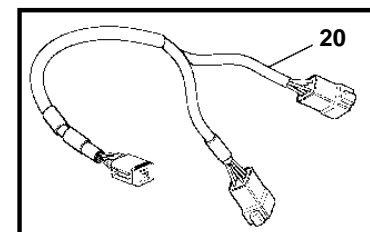
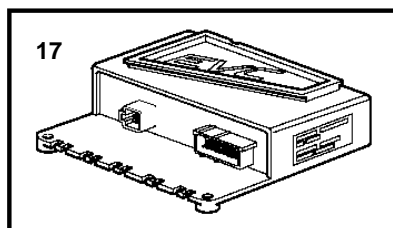
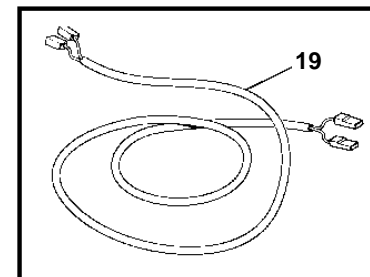
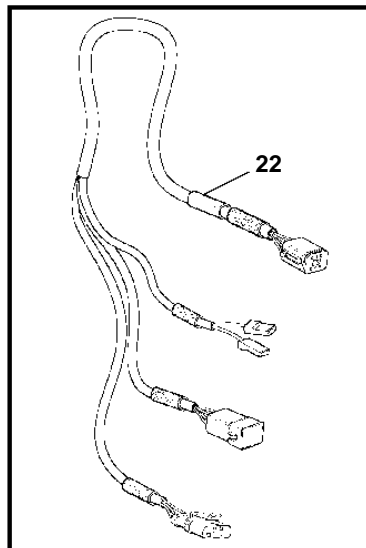
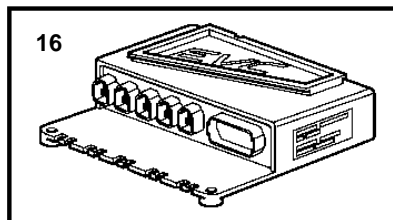
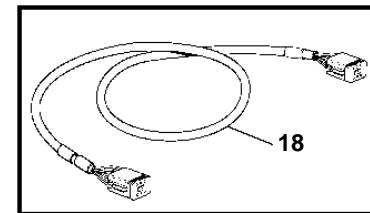
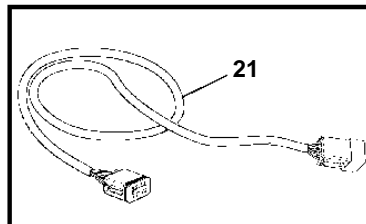
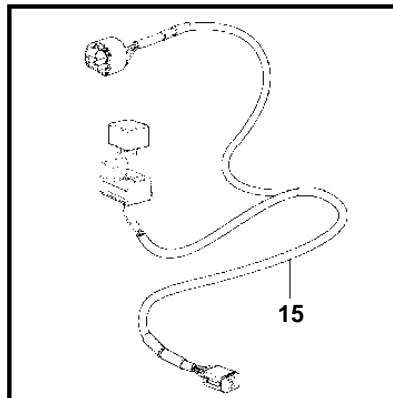
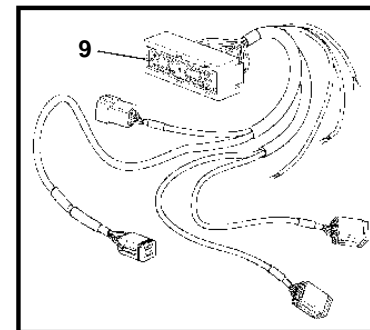
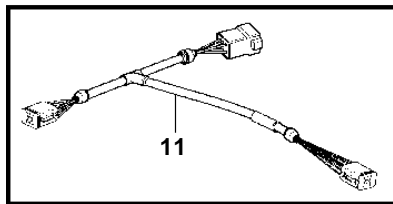
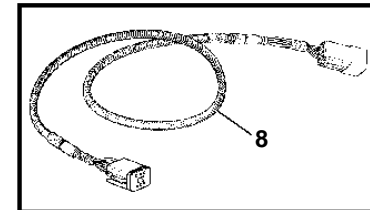
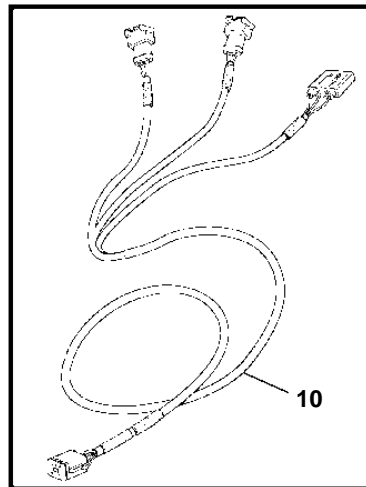
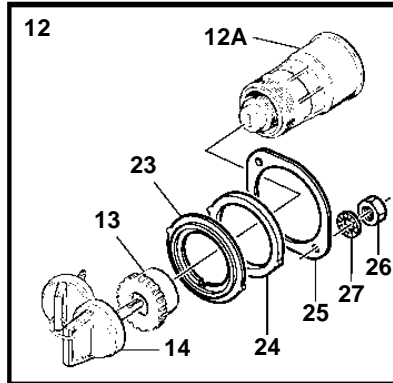
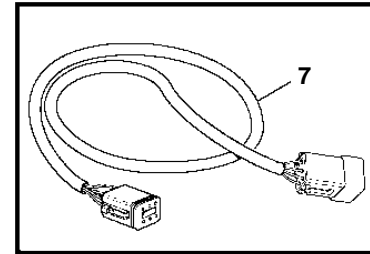
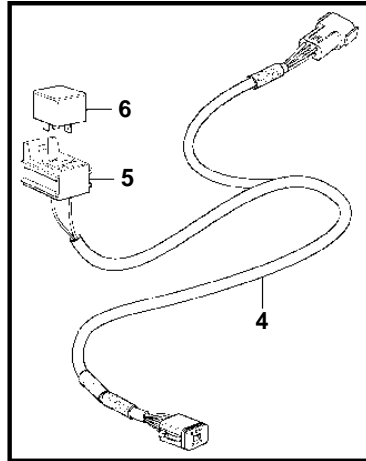
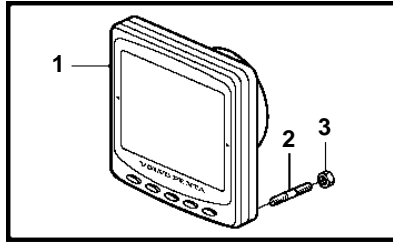

21605

D12D-B MP

REF	PART NO.	QTY	DESCRIPTION	SEE SEC.	NOTES
1	3840958	1	Display		(3588849)
2	830928	4	Stud		
3	830930	4	Nut		
4	881786	1	Cable kit		
5	977184	1	Tab housing		
6	873765	1	Relay		12V
	20374662	1	Relay		24V
7	874752	1	Cable kit		L=1,5m
8	874779	1	Extension cable		L=3,0m
	874780	1	Extension cable		L=5,0m
	874781	1	Extension cable		L=7,0m
	874782	1	Extension cable		L=9,0m
	874783	1	Extension cable		L=11,0m
	874789	1	Cable kit		L=5,0m. PCU-HCU, 6 pole.
	889550	1	Cable		L=7,0m. PCU-HCU, 6 pole.
	889551	1	Cable		L=9,0m. PCU-HCU, 6 pole.
	889552	1	Cable		L=11,0m. PCU-HCU, 6 pole.
	888013	1	Cable		L=13,0m. PCU-HCU, 6 pole.
	888243	1	Cable		L=3,0m. Extension cables. Multilink, 6-pin.
	888244	1	Cable		L=5,0m. Extension cables. Multilink, 6-pin.
	888245	1	Cable		L=7,0m. Extension cables. Multilink, 6-pin.
	888246	1	Cable		L=9,0m. Without atmospheric pressure sensor.
	888247	1	Cable		L=11,0m. Extension cables. Multilink, 6-pin.
9	3808579	1	Wiring harness		L=3,0m. Engine-PCU cable.
	3808580	1	Wiring harness		L=5,0m. Engine-PCU cable.
10	874676	1	Cable kit		L=1,5m. EVC control lever cable, 6-pole.
11	3588972	1	Cable kit		L=0,5m. T-connector bus cable, 6-pole.
12	3587070	1	Starter switch, set		Kit with 2 key switch with identical key.
12A	3587071	1	Starter switch		
13	859955	1	• Plastic nut		
14	859953	1	• Key		State key code when ordering.
			• Bulletin 49-30	49-30-EN	Key P/N 859953
15	888004	1	Cable, starter switch		
16	3840320	X	Control unit, not programmed		HCU. Software ordered separately or downloaded with VODIA.
	3586261	X	Update	SO	Warehouse programming. This p/n can not be ordered, but will be used for invoicing.
	3586259	X	Update	SO	Vodia-programming. This p/n can not be ordered, but will be used for invoicing.
17	3840321	X	Control unit, not programmed		PCU. Software ordered separately or downloaded with VODIA.
	3586267	X	Update	SO	Warehouse programming. This p/n can not be ordered, but will be used for invoicing.
	3586266	X	Update	SO	Vodia-programming. This p/n can not be ordered, but will be used for invoicing.
18	3588208	1	Cable kit, synchronizing		Syncronicing cabel for twin installation. 6 pole.
19	874807	1	Cable kit, fuel, water, rudder		
20	3588206	1	Cable kit, y-connector		
21	3588207	1	Cable kit, display		
22	3808852	1	Cable kit, instruments, panels		
23	3589932	1	Sleeve		Adapter, starter switch.
24	3809239	1	Spacer ring		Adapter, starter switch.
25	3808694	1	Lock ring		Adapter, starter switch.
26	984990	2	Nut		Adapter, starter switch.
27	984991	2	Washer		Adapter, starter switch.