

D11A-A, D11A-B, D11A-C, D11A-D

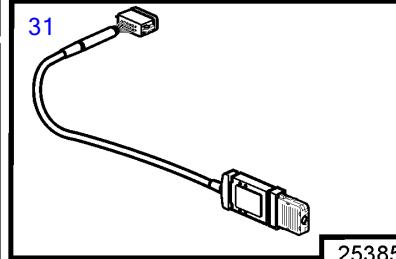
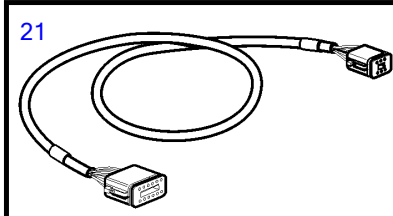
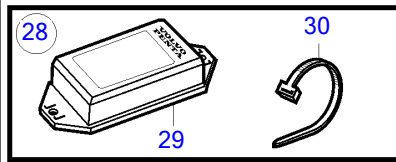
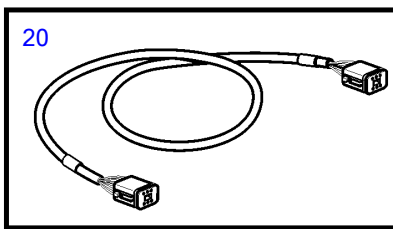
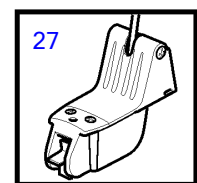
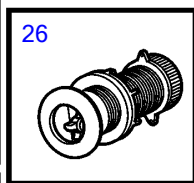
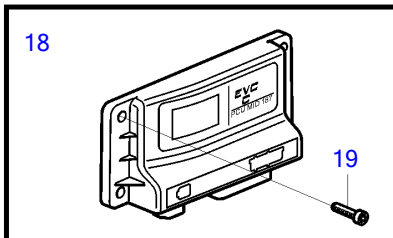
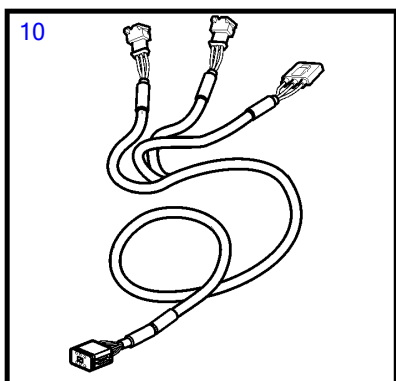
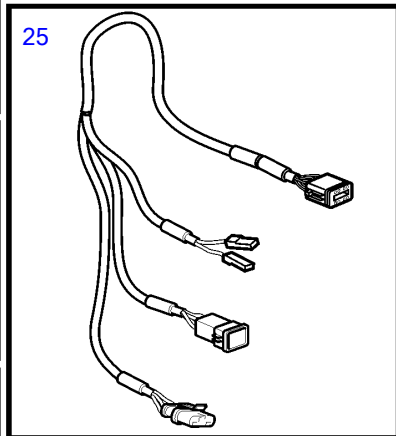
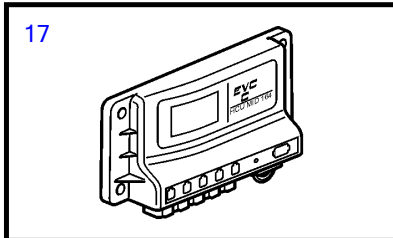
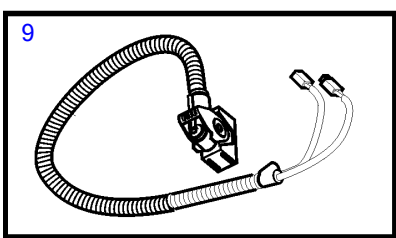
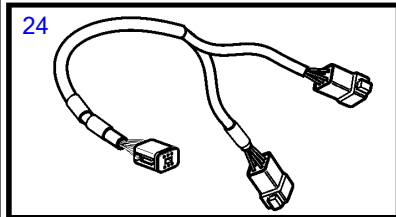
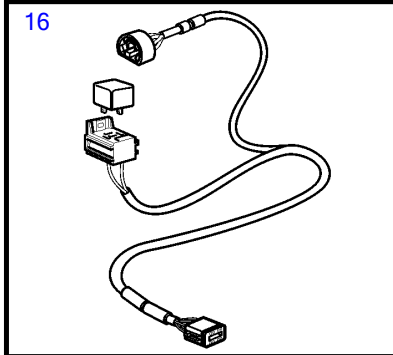
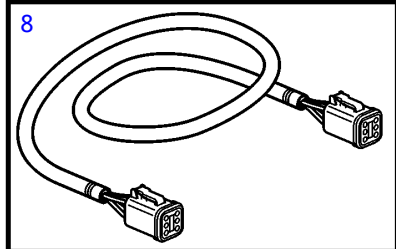
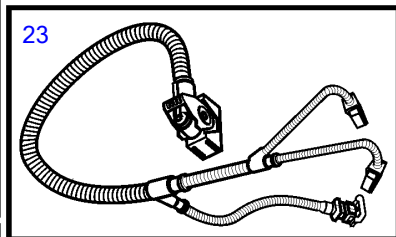
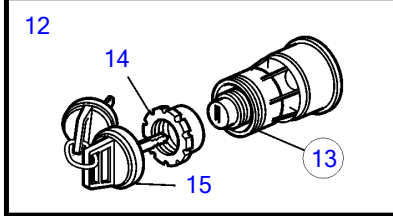
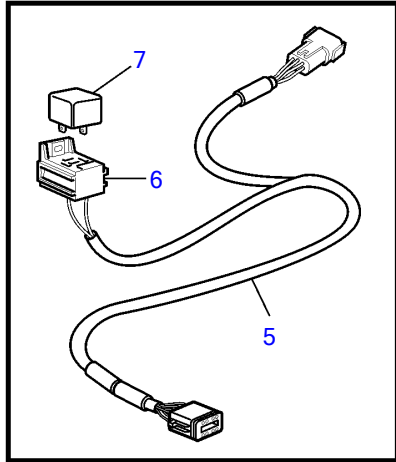
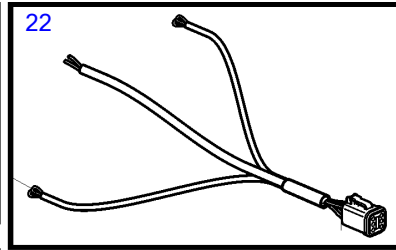
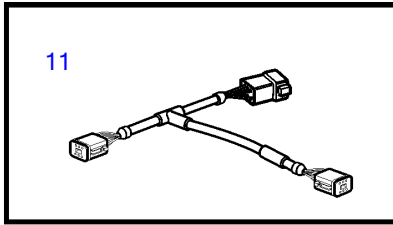
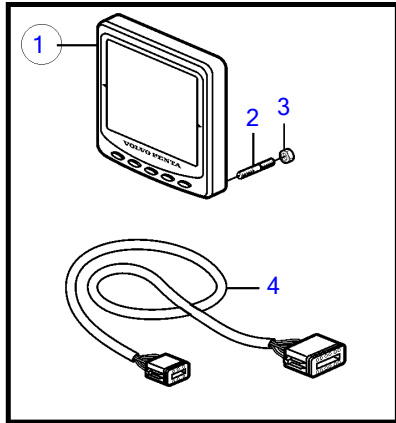

25385

D11A-A, D11A-B, D11A-C, D11A-D

REF	PART NO.	QTY	DESCRIPTION	SEE SEC.	NOTES
1	21173162	1	Display		
2	830928	4	• Stud		
3	830930	4	• Nut		
4	3588207	1	• Cable kit		
5	881786	1	Cable kit		
6	977184	1	Housing		
7	873765	1	Relay		12V
	3171420	1	Relay		24V
8	3842733	1	Extension cable'verl		L=3.0m
	3842734	1	Extension cable'verl		L=5.0m
	3842735	1	Extension cable'verl		L=7.0m
	3842736	1	Extension cable'verl		L=9.0m
	3842737	1	Extension cable'verl		L=11.0m
	21172469	1	Extension cable'verl		L=20m
	21172470	1	Extension cable'verl		L=40m
	874789	1	Cable kit		PCU-HCU, 6 pole, L=5.0m
	889550	1	Cable		PCU-HCU, 6 pole, L=7.0m
	889551	1	Cable		PCU-HCU, 6 pole, L=9.0m
	889552	1	Cable		PCU-HCU, 6 pole, L=11.0m
	888013	1	Cable		PCU-HCU, 6 pole, L=13.0m
9	40005754	1	Wiring harness		Engine-PCU cable., L=2.65m
10	874676	1	Cable kit		EVC control lever cable, 6-pole., L=1.5m
11	3588972	1	Cable kit		T-connector bus cable, 6-pole., L=0.5m
12	3587070	1	Starter switch, set		Kit with 2 key switch with identical key.
13	3587071	1	Starter switch		
14	859955	1	• Plastic nut		
15	859953	1	• Key		State key code when ordering.
			• Bulletin 49-30	49-30-EN	Key P/N 859953
16	888004	1	Cable, starter switch		
17	21339291	X	Control unit, not programmed		HCU. Software ordered separately or downloaded with Vodia.
	3586261	X	Software		Warehouse programming. This p/n can not be ordered, but will be used for invoicing.
	3586259	X	Software		Vodia-programming. This p/n can not be ordered, but will be used for invoicing.
	21172467		Control unit		XCU
18	21339311	X	Control unit, not programmed		PCU. Software ordered separately or downloaded with Vodia.
	3586267	X	Software		Warehouse programming. This p/n can not be ordered, but will be used for invoicing.
	3586266	X	Software		Vodia-programming. This p/n can not be ordered, but will be used for invoicing.
19	976104	4	Flange screw		
20	3886666	1	Cable, synchronizing		Synchronizing cabel for twin installation. 6 pole., L=1.5m
	21166002	1	Wiring harness		L=7m
	21166003	1	Wiring harness		L=9m
	21166004	1	Wiring harness		L=13m
21	3885343	1	Wiring harness		Triple and quadruple installation.
22	3807229	1	Wiring harness, fuel		
23	40005753	1	Wiring harness		
24	3588206	1	Cable kit, y-split		For connecting extra equipment to Multilink
25	3808852	1	Cable kit, instruments, panels		
26	3587054	1	Sensor		Through hull
27	3587055	1	Sensor		Mounted on transom
28	(21281264)	1	Converter		Obsolete part
29		1	• Converter		
30	948211	2	• Cable tie		
31	21509941	1	Control unit		