

D11A-D, D11A-D MP IPS

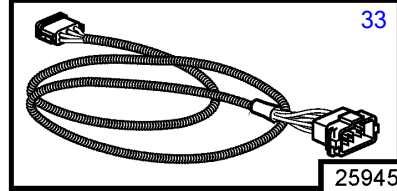
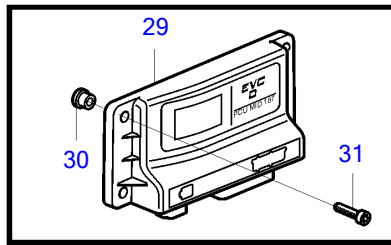
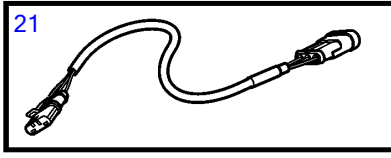
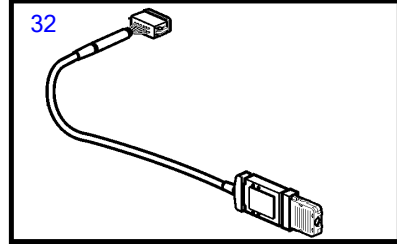
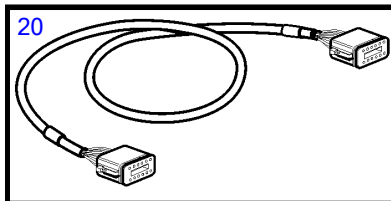
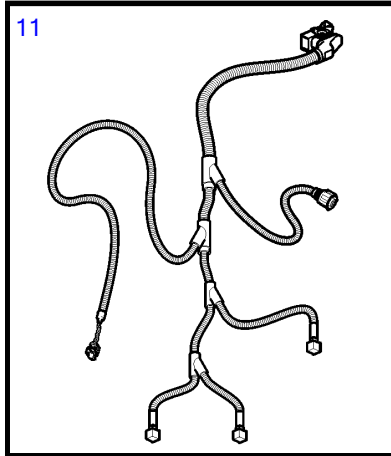
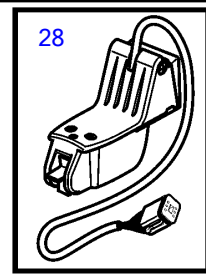
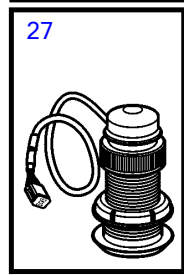
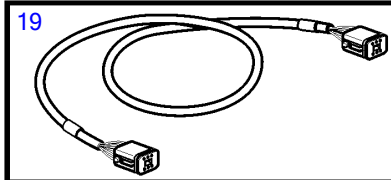
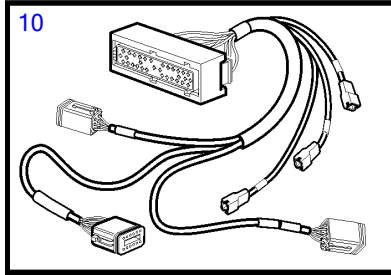
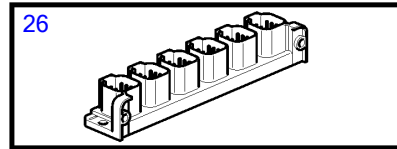
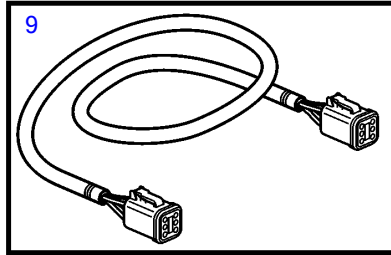
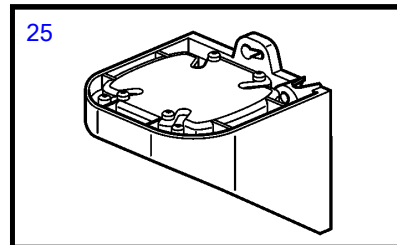
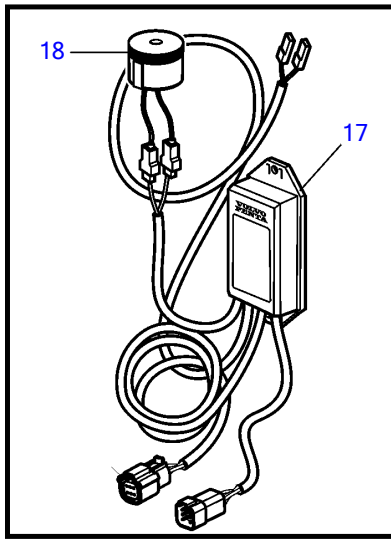
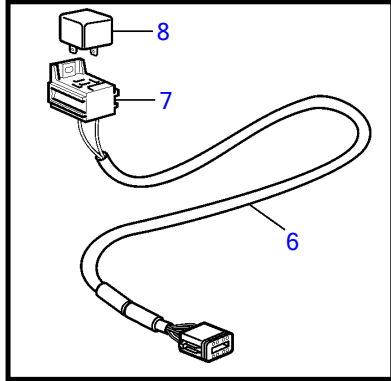
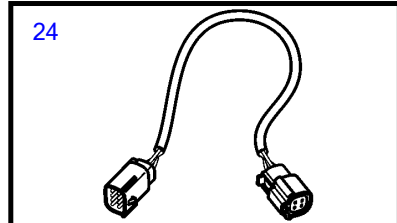
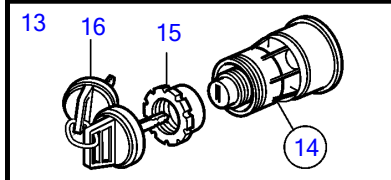
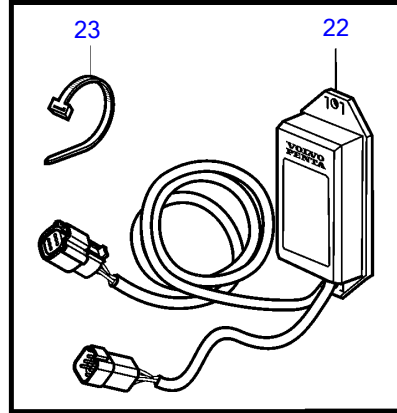
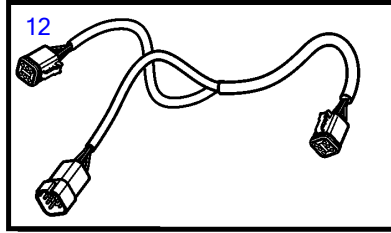
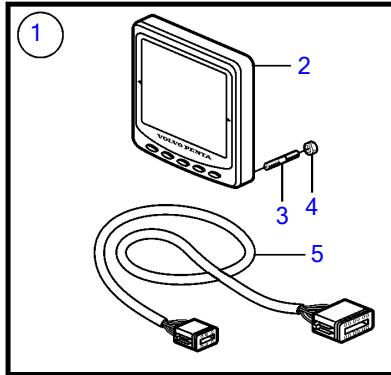

25945

## D11A-D, D11A-D MP IPS

REF	PART NO.	QTY	DESCRIPTION	SEE SEC.	NOTES
1	21352262	1	Display		Information display, Replaced by 21631438
	21631438	1	Kit		
2		1	• Display		
3	830928	4	• Stud		
4	830930	4	• Nut		
5	3588207	1	• Cable kit		
6	21450563	1	Cable		Relay cable. 6-pin. L=1,5m
7	977184	1	• Housing		
8	873765	1	Relay		12V
	3171420	1	Relay		24V
9	874789	1	Cable kit		other EVC bus cable, 6-pin, L=5.0m
	889550	1	Cable		other EVC bus cable, 6-pin, L=7.0m
	889551	1	Cable		other EVC bus cable, 6-pin, L=9.0m
	889552	1	Cable		other EVC bus cable, 6-pin, L=11.0m
	888013	1	Cable		other EVC bus cable, 6-pin, L=13.0m
10	21122603	1	Cable		Engine-PCU cable., L=3.0m
	21122605	1	Cable		Engine-PCU cable., L=5.0m
11	40005751	1	Wiring harness		Transmission ZF, L=6.0' (1.8m)
	(40005752)	1	Wiring harness		Obsolete part, Transmission MG, L=6.0' (1.8m)
	21159075	1	Wiring harness		Transmission MGX, L=1,2m
12	3588972	1	Cable kit		Y-connector bus cable, 6-pole. HCU, PCU, SUS, L=0.5m
13	3587070	1	Starter switch		Kit with 2 key switch with identical key.
14	3587071	2	• Starter switch		
15	859955	1	• • Plastic nut		
16	859953	1	• • Key		State key code when ordering.
			• Bulletin 49-30	49-30-EN	Key P/N 859953
17	21461496	1	Network adapter		Analog key interface
18	3817974	1	• Alarm		
19	3886666	1	Cable		Multilink/tachometer/synchronization cable, 6-pin. L=1,5m
20	3889410	1	Extension cable'verl		L=1.5m
	3842733	1	Extension cable'verl		L=3.0m
	3842734	1	Extension cable'verl		L=5.0m
	3842735	1	Extension cable'verl		L=7.0m
	3842736	1	Extension cable'verl		L=9.0m
	3842737	1	Extension cable'verl		L=11.0m
	21172469	1	Extension cable'verl		L=20,0m
	21172470	1	Extension cable'verl		L=40,0m
21	874759	1	Extension cable'verl		3-pin, L=1,0m
	3807043	1	Extension cable'verl		3-pin, L=3.0m
22	21460908	1	Converter		Analog lever interface
23	948211	X	Cable tie		State key code when ordering.
24	21421946	1	Cable		AKI connection 4/8 pin
	21421945		Cable		4-20mA interface
25	21520222	1	Control unit		HCU. separate mounting, Software ordered separately or downloaded with Vodia.
	3586259	1	Software		Vodia-programming. This p/n can not be ordered, but will be used for invoicing.
	3586261	1	Software		Warehouse programming. This p/n can not be ordered, but will be used for invoicing.
26	21469055	1	Connection block		
27	3587054	1	Sensor		Through hull
28	3587055	1	Sensor		Mounted on transom
29	21469059	X	Control unit, not programmed		PCU. Software ordered separately or downloaded with Vodia.
	3586267	X	Software		Warehouse programming. This p/n can not be ordered, but will be used for invoicing.
	3586266	X	Software		Vodia-programming. This p/n can not be ordered, but will be used for invoicing.
30	21230875	2	• Sleeve		1 pce 21230875 includes 4 pcs sleeve.
31	976104	4	Flange screw		
32	21509941	1	Control unit		
33	874387	1	Extension cable'verl		Connection cable EDC, CIU., L=9.0m

7749110-30-36092

25945

Upd:2012-02-28