

AD41D, D41D, TAM41D, TMD41D

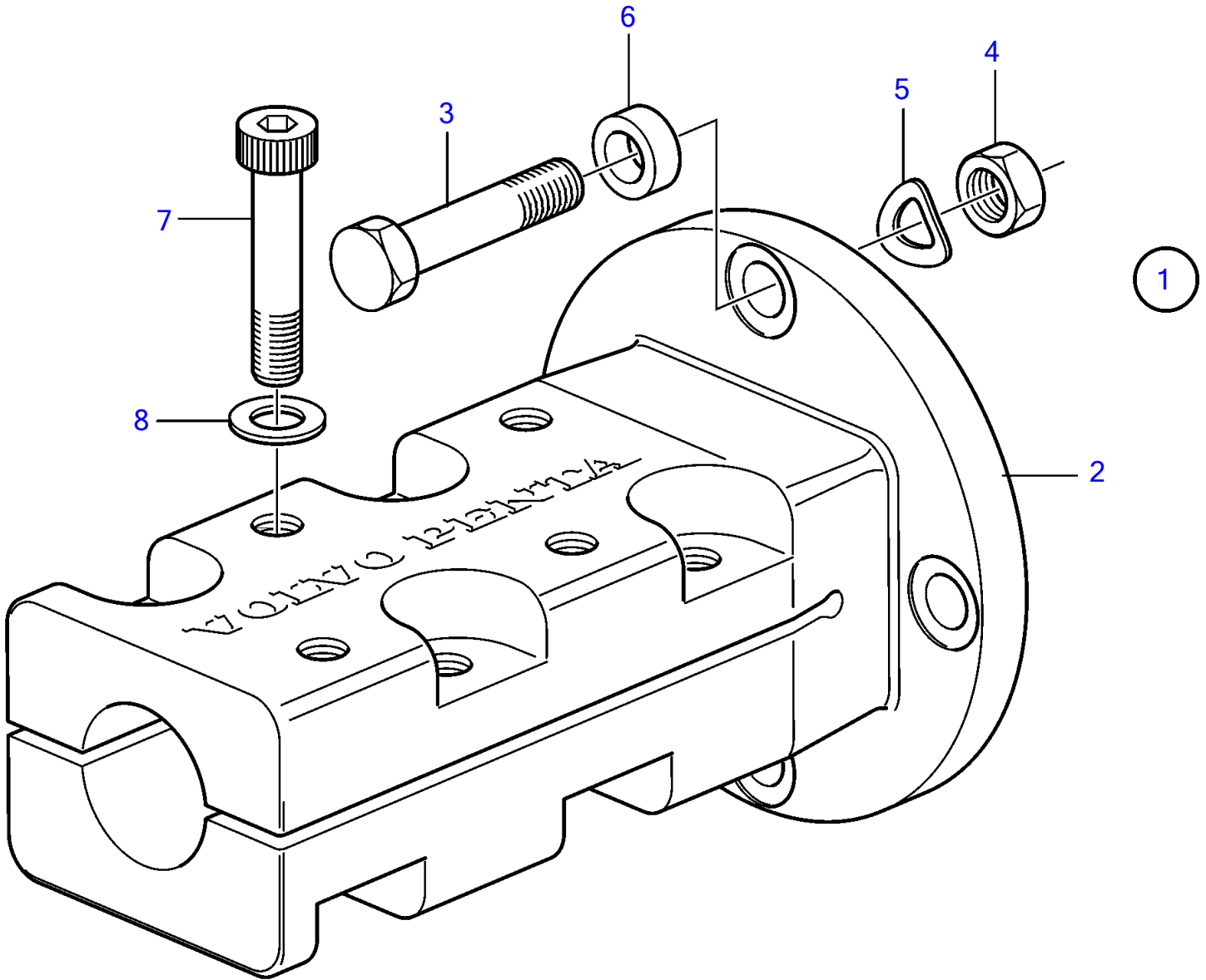

11346

AD41D, D41D, TAMD41D, TMD41D

REF	PART NO.	QTY	DESCRIPTION	NOTES
1	872945	1	Clamp coupling	
2		1	• Flange	
3	955694	4	• Hexagon screw	
4	950375	4	• Lock nut	
5	941909	4	• Spring washer	
6	860699	4	• Spacer sleeve	Should not be used on KAMD42., Early type L=7mm, for HS1A
7	948670	8	• Hex. socket screw	
8	947345	8	• Washer	